

User Manual



Contents

1.0	Installation Overview	3
1.1	<i>Introduction</i>	3
1.2	<i>Specifications</i>	4
2.0	Warnings	5
3.0	Tools and Materials Needed	5
4.0	Choosing a Location	6
5.0	Installation Instructions	6
6.0	Wiring Diagram	9
6.1	<i>Charging Only One Battery</i>	9
6.2	<i>Charging Two Batteries</i>	9
7.0	Operating Instructions	10
7.1	<i>Power Up</i>	10
7.2	<i>Setting the Battery Type and Charging Profile</i>	11
7.3	<i>Battery Charging Profile Chart</i>	12
7.4	<i>Maximum Power Boost Technology™</i>	13
7.5	<i>Viewing the Controller Display Information</i>	13
7.6	<i>Errors</i>	16
8.0	Display Symbols	17
9.0	Inverter Control (on/off)	19
10.0	USB Charging	20
11.0	Frequently Asked Questions (FAQs)	20
12.0	Troubleshooting Problems	21
12.1	<i>Problems with the Display</i>	21
12.2	<i>Problems with Voltage</i>	22
12.3	<i>Problems with Current</i>	23
13.0	Limited Warranty	25
13.1	<i>Repair and Return Information</i>	26
14.0	Installation Template	26

1.0 Installation Overview

1.1 Introduction

A Solar Controller (or Charge Controller / Regulator) is an essential component of your photovoltaic solar system. The Controller maintains the life of the battery by protecting it from overcharging. When your battery has reached a 100% state of charge, the Controller prevents overcharging by limiting the current flowing into the batteries from your solar array.

The GP-PWM-30 is a 12-volt flush mounted photovoltaic (PV) charge controller rated for a continuous solar current input of 30 amps. The GP-PWM-30 uses Pulse Width Modulation (PWM) technology and a unique four stage charging system that includes an optional equalize setting to charge and protect your battery bank. The GP-PWM-30 features an LCD digital display that shows the charge current of the solar array, system battery voltage and battery capacity. The GP-PWM-30 also features Maximum Power Boost Technology™ for manual bulk charge at any stage of the charge cycle.







1.2 Specifications

Description	Value	Dimensions (H x W x D):
Nominal System Voltage	12V	108 x 190 x 35 mm 4.25 x 7.48 x 1.38 in Weight: 300g / 10.6 oz Maximum Wire Gauge: #4 AWG Warranty: 5 years <ul style="list-style-type: none"> • PWM Charging • 3 Battery Charging profiles • 4 Stage Charging • Monthly Equalize option • Displays Charging Current, Battery Voltage and Battery State of Charge • Reverse Polarity protected • Temperature Compensated • RoHS Compliant, environmentally safe • Accepts up to 495 watts of solar at 12 volts • Maximum Power Boost Technology
Max. Solar Array Current Battery 1	30 amps Amperage is reduced above 50°C	
Max Solar Array Current Battery 2	30 amps Amperage is reduced above 50°C	
Battery 1 Voltage Range	9V – 15.5V	
Battery 2 Voltage Range	9V – 15.5V	
Max. Solar Voltage	28V	
Operating Consumption (Display backlight on)	15mA	
Operating Consumption (Display backlight off)	6mA	
Bulk/Absorption Voltage (Sealed/Gel, AGM, Flooded)	14.1/14.4/14.4V (25°C / 77°F), 1 - 2h / Day	
Float Voltage	13.7V (25°C / 77°F)	
Equalization Voltage	14.9V (25°C / 77°F), 2h / 28 Day or V < 12.1	
Temperature Compensation	- 24mV/°C / -13V/°F	
USB charger	5V, 800mA	
Operating Temperature	- 40 to 85°C / - 40 to 185°F	
Display Operating Temperature	- 10 to 55°C / - 14 to 131°F	
Humidity	99% N.C.	
Protection	Battery Reverse Polarity, Solar Array Reverse Polarity, Over Temperature, PV Short Circuit, Over Current	

The total rated Maximum Power Current (Imp) of the PV input should not exceed 30 amps.

The GP-PWM-30 will limit PV current above 30 Amps. Although the GP-PWM-30 will accept PV current greater than 30 Amps for a short duration, damage may occur if the GP-PWM-30 operates continuously with greater than 30 Amps of PV input.

2.0 Warnings

	Disconnect all power sources	Electricity can be very dangerous. Installation should be performed only by a licensed electrician or qualified personnel.
	Battery and wiring safety	Observe all safety precautions of the battery manufacturer when handling or working around batteries. When charging, batteries produce hydrogen gas, which is highly explosive.
	Wiring connections	Ensure all connections are tight and secure. Loose connections may generate sparks and heat. Be sure to check connections one week after installation to ensure they are still tight.
	Work safely	Wear protective eyewear and appropriate clothing during installation. Use extreme caution when working with electricity and when handling and working around batteries.
	Observe correct polarity	Reverse polarity of the Battery 1 terminals and array will cause the controller to give a warning tone. Reverse connection of Battery 2 terminals will not cause an alarm. However, the controller will not charge or display information for Battery 2 on the LCD. The controller will not function unless Battery 1 terminals are connected to a battery with proper polarity. Failure to correct this fault could damage the controller.
	Do not exceed the GP-PWM-30 Amp current and max voltage ratings	The current rating of the solar system is the sum of the Maximum Power Current (Imp) of the solar PV strings in parallel. The resulting system Imp current is not to exceed 30A. The voltage of the array is the rated open circuit voltage (Voc) of the PV array and is not to exceed 28V. If your solar system exceeds these ratings, contact your dealer for a suitable controller alternative.

3.0 Tools and Materials Needed

- Flathead Screwdriver (for wire terminals)
- Philips Screwdriver (for mounting screws)

NOTE

If the GP-PWM-30 Controller was purchased with a Go Power! RV Solar Power Kit then UV resistant wire is included. For instructions regarding the Go Power! RV Solar Power Kit installation, please refer to the Installation Guide provided with the Kit.

4.0 Choosing a Location

The GP-PWM-30 is designed to be mounted flush against a wall, out of the way but easily visible.

The GP-PWM-30 should be:

- Mounted as close to battery 1 as possible
- Mounted on a vertical surface to optimize cooling of the unit
- Indoors, protected from the weather

In an RV, the most common controller location is above the refrigerator. The wire from the solar array most commonly enters the RV through the fridge vent on the roof or by using the Go Power! Cable Entry Plate (sold separately) that allows installers to run wires through any part of the roof. PV connections should connect directly to the controller. Positive and negative battery connections must connect directly from the controller to the batteries. Use of a positive or negative distribution bus is allowed between the controller and battery as long as it is properly sized, electrically safe and an adequate wire size is maintained.

5.0 Installation Instructions

1. **Prepare for mounting.** Use the template provided on **page 27** to mark the four mounting holes and the cutting line for flush mounting your controller.
2. **Complete the installation of the solar modules.** If this GP-PWM-30 was purchased as part of a Go Power! Solar Power Kit, follow the Installation Guide provided. Otherwise, follow manufacturer's instructions for solar module mounting and wiring.
3. **Select wire type and gauge.** If this GP-PWM-30 was purchased as part of a Go Power! Solar Power Kit, appropriate wire type, gauge and length is provided. Please continue to **Section 6**, "Operating Instructions." If the GP-PWM-30 was purchased separately, follow the instructions included here.

Wire type is recommended to be a stranded copper UV resistant wire. Wire fatigue and the likelihood of a loose connection are greatly reduced in stranded wire compared to solid wire. Wire gauge should be able to sustain rated current as well as minimizing voltage drop.

Wire Strip Gauge

You will find a strip gauge diagram on the back of the GP-PWM-30, which helps you to strip your wires to the correct length. Insert wire into the concave slot of the strip gauge until it meets the back of the Strip Gauge slot. Mark the length of wire from the back of the Strip Gauge slot to the edge of the controller with a pen or your finger and strip all wires to be connected to the controller to this length.

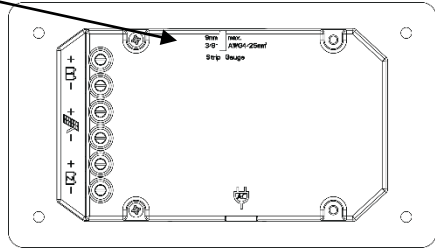

Suggested Minimum Wire Gauge

(Cable length 25 ft. max. from solar array to battery bank)

50 Watt Solar Module	#14 Wire Gauge
80 Watt Solar Module	#12 Wire Gauge
95 Watt Solar Module	#10 Wire Gauge
110 Watt Solar Module	#10 Wire Gauge
125 Watt Solar Module	#10 Wire Gauge
160 Watt Solar Module	#10 Wire Gauge
240 Watt Solar Module	#10 Wire Gauge
Terminal Screw Torque	16 inch pounds (1.8N.m)

IMPORTANT: Identify the polarity (positive and negative) on the cable used for the battery and solar module. Use colored wires or mark the wire ends with tags. Although the GP-PWM-30 is protected, a reverse polarity contact may damage the unit.

Wiring the GP-PWM-30. Wire the GP-PWM-30 according to the wiring schematic in **Section 6**. Run wires from the solar array and the batteries to the location of the GP-PWM-30. Keep the solar array covered with an opaque material until all wiring is completed.

- 4. Torque** all terminal screws to 16 inch pounds (1.8N.m). Connect the battery wiring to the controller first and then connect the battery wiring to the battery.

IMPORTANT: Always use appropriate circuit protection on any conductor attached to a battery.

With battery power attached, the controller should power up and display information. Connect the solar wiring to the controller and remove the opaque material from the solar array. The negative solar array and battery wiring must be connected directly to the controller for proper operation. Do not connect the negative solar array or negative battery controller wiring to the chassis of the vehicle.

- 5. Mounting the GP-PWM-30.** Mount the GP-PWM-30 to the wall using the included four mounting screws.

IMPORTANT: You must set the battery type on the GP-PWM-30 before you begin to use the controller. The default battery setting is for AGM batteries.

Congratulations, your GP-PWM-30 should now be operational. If the battery power is low and the solar array is producing power, your battery should begin to charge.

- 6. Re-torque:** After 30 days of operation, re-torque all terminal screws to ensure the wires are properly secured to the controller.

6.0 Wiring Diagram

The GP-PWM-30 is based on a 30 amp max input from the solar modules. E.G. Three modules in parallel with an input of 7 amps each equal a total input of 21 amps. Most solar modules list the input amps on their specifications label.

6.1 Charging Only One Battery

Use the following wiring diagram if you are using the GP-PWM-30 to charge only one battery. Connect your battery to the battery 1 terminals on the solar controller.

NOTE The controller will not work unless there is a battery connected to the Battery 1 terminals

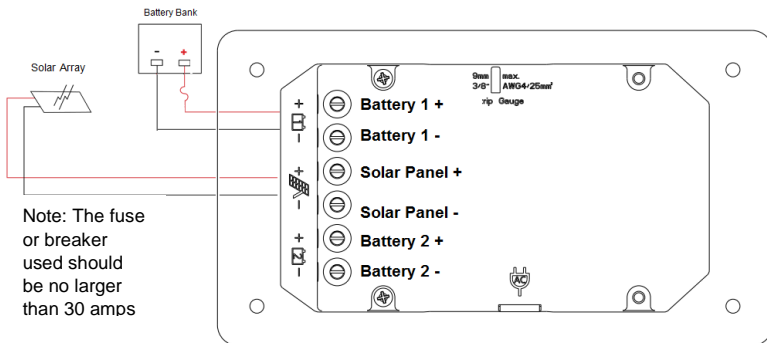

6.2 Charging Two Batteries

Use the following wiring diagram if you are using the GP-PWM-30 to charge two batteries. Connect battery 1 to the battery 1 terminals and battery 2 to the battery 2 terminals on the back of the solar controller.

Important: Ensure your primary/permanent battery (house bank) is connected to the battery 1 terminals. Connect your secondary battery (starting, trolling) to battery 2 terminals only. Your permanent battery (battery 1) will receive the full current first. Once battery 1 is fully charged, the full current will be available to charge battery 2.

NOTE

The controller will not work unless there is a battery connected to the battery 1 terminals.

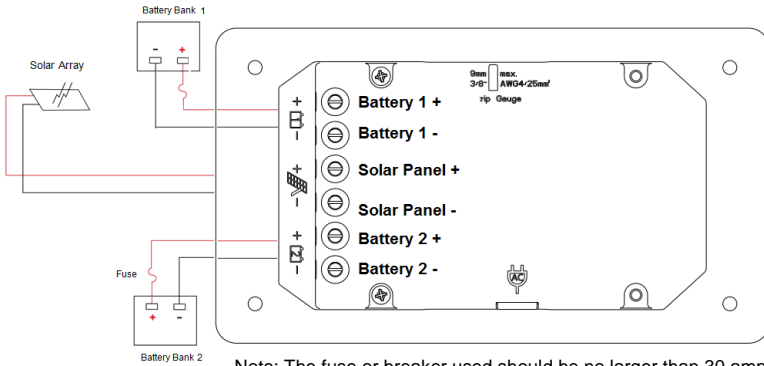

Note: The fuse or breaker used should be no larger than 30 amps

7.0 Operating Instructions

7.1 Power Up

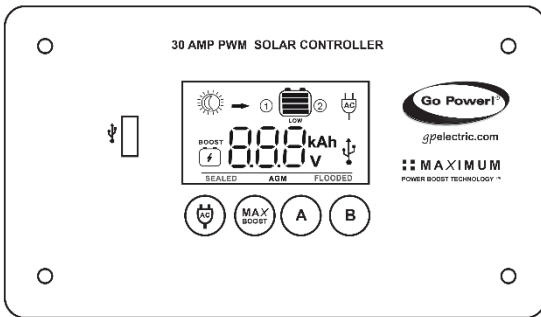

When the GP-PWM-30 is connected to the battery, the controller will go into Power Up mode.

Icons Displayed: All segments of the numerical display; Backlight blinks

Depending on the battery voltage when the GP-PWM-30 Power Up occurs, the controller may do a Boost Charge or quickly go into Float Charge. The Charging Profile selected will commence the following day after a Power Up (refer to the Charging Profile Chart on page 13 for more details).

7.2 Setting the Battery Type and Charging Profile

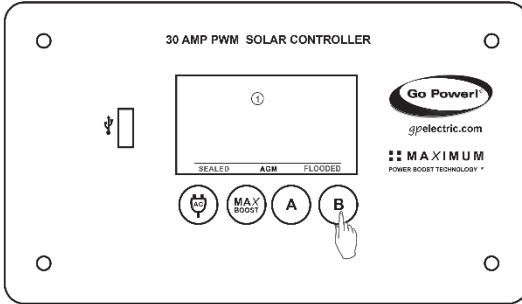

Setting Battery 1

To set the battery type for Battery 1, hold the **B Button** for 3 seconds. When the display shows a blinking number 1, release the **B Button**.

Next, select the charging profile of Battery 1 by pressing the **B Button** to toggle through the profile options: Sealed/Gel, AGM or Flooded.

To confirm the battery profile, press and hold the **A Button** for 3 seconds.

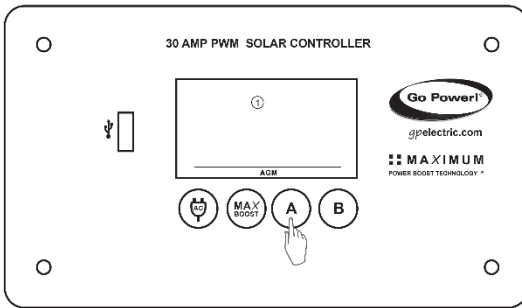

Setting Battery 2

If you have a second battery connected, the controller will immediately prompt you to set the battery type for Battery 2 with a blinking number 2.

To select the charging profile of Battery 2, press the **B Button** to toggle through the profile options: Sealed/Gel, AGM or Flooded.

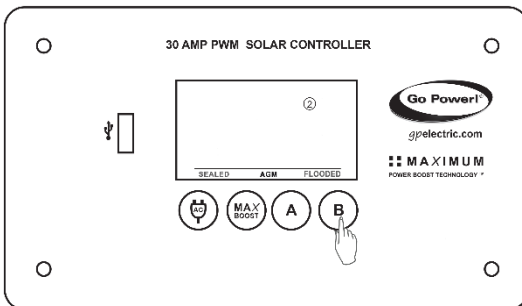

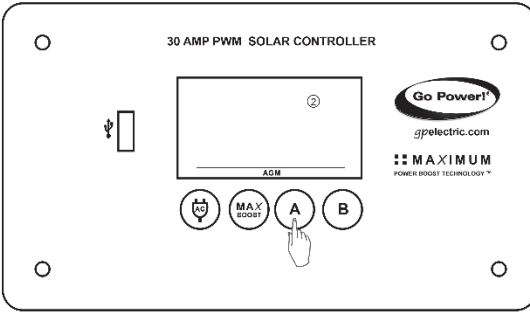

To confirm the battery profile, press and hold the **A Button** for 3 seconds.

NOTE If there is not a second battery connected to the controller, or if the

second battery is connected with reverse polarity, the controller will not prompt you to select battery type for Battery 2 and no status information will be displayed on the LCD screen.

Non-volatile memory: Any settings made on the GP-PWM-30 will be saved even when the power has been disconnected from the controller.

Refer to the Battery Charge Profile Chart below for details on each profile.

7.3 Battery Charging Profile Chart

Battery Type	SEALED /GEL	AGM	FLOODED
Float Charge @ 25°C:	13.7V (+/- 0.1V)		
Bulk/Absorption Charge @ 25°C: Set to 30 minutes every morning. <i>Applied for 1 hour if the battery voltage drops below 12.3 volts.</i>	14.1V (+/- 0.1V)	14.4V (+/- 0.1V)	14.4V (+/- 0.1V)
Equalization Charge: <i>Applied for 2 hours every 28 days and if the battery voltage drops below 12.1 volts.</i>	N/A	N/A	14.8V (+/-0.1V)
If a charging cycle is unable to complete in a single day, it will continue the following day.			
The terms SEALED/GEL, AGM and FLOODED are generic battery designations. Choose the charging profile that works best with your battery manufacturer's recommendations.			

Auto Equalize: The GP-PWM-30 has an automatic equalize feature that will charge and recondition your batteries once a month at a higher voltage to ensure that any excess sulfation is removed.

NOTE This feature is only available when Flooded batteries are selected.

7.4 Maximum Power Boost Technology™

Maximum Power Boost Technology™ (MPBT) allows you to override the normal charging algorithm of the solar controller. MPBT is designed to be used before the end of the day, if you know you will require many loads through the night. This feature can also be used when you have just installed the solar controller, to put batteries on a boost charge up to 14.4 (Flooded and AGM) (14.1 for Sealed/Gel) right away.

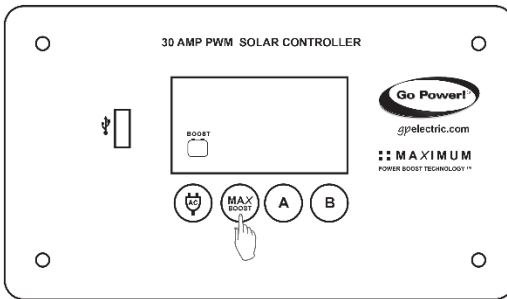

To activate, hold the **MAX BOOST Button** for 3 seconds. As long as there is full sunlight present, your battery voltage will be boosted (to 14.4V for Flooded and AGM and 14.1V for SEALED/GEL) for 30 minutes regardless of the battery's state of charge.

Icons Displayed: BOOST; Battery Symbol

IMPORTANT: Do not use the Maximum Power Boost function more than twice a day as it could damage your batteries due to gassing.

7.5 Viewing the Controller Display Information

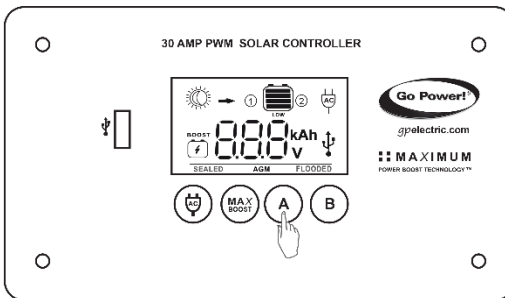

The GP-PWM-30 has two modes to watch the display information, manual and auto scroll.

You can change between the two modes by holding down the **A Button** for 3 seconds.

Mode 1: Manually Scroll Through Display Information

Battery 1 Status Values

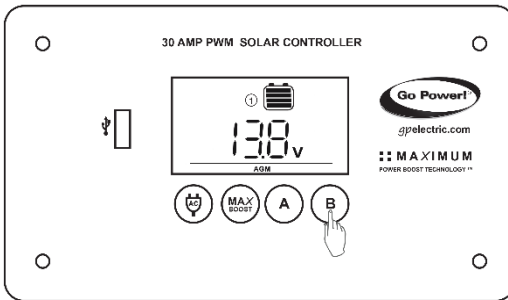

To toggle between Battery Voltage, PV Charging Current and Battery State of Charge (SOC) for Battery 1 and 2, press the **B Button**.

Push the **B Button** to show the voltage for Battery 1.

Icons Displayed: Battery SOC, Volt Symbol (V), Symbol 1

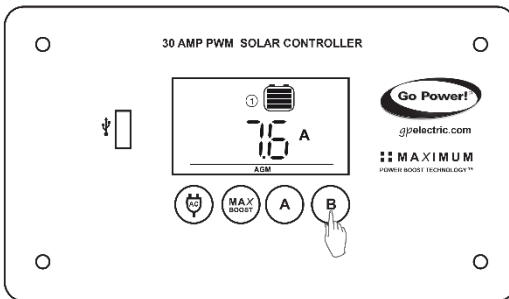

Push the **B Button** to show the PV charging current for battery 1. The GP-PWM-30 will begin to limit the current as Battery 1 reaches a full charge. The current that is not used for Battery 1, is used to charge Battery 2.

Icons Displayed: Arrow, Ampere Symbol (A), Battery SOC, Symbol 1

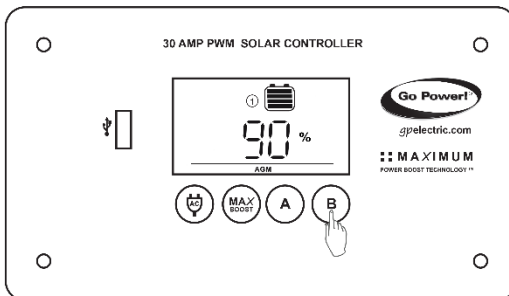

The battery state of charge is shown as a percentage.

Icons Displayed: Battery SOC, Percent Symbol (%), Symbol 1

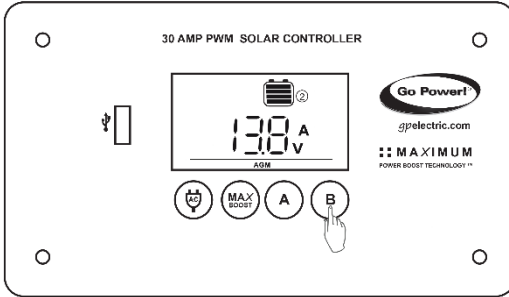

Battery 2 Status Values

Push the **B Button** to show the battery 2 voltage.

Icons Displayed: Battery SOC, Volt Symbol (V), Symbol 2

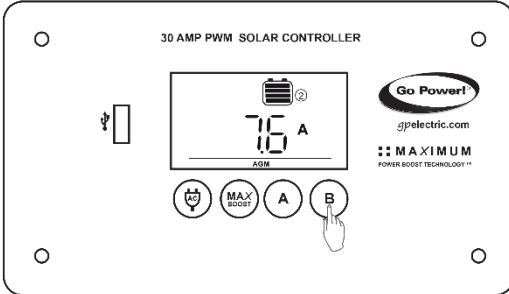

Push the **B Button** to show the PV charging current for battery 2. The GP-PWM-30 will begin to limit the current as the battery 2 reaches a full charge.

Icons Displayed: Arrow, Ampere Symbol, Battery SOC, Symbol 2

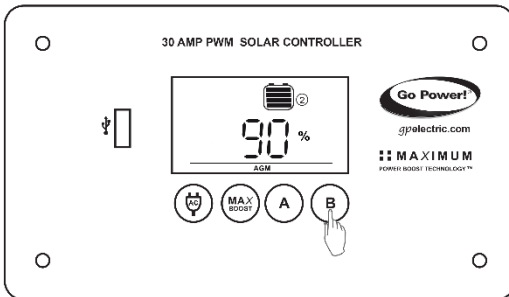

The battery state of charge is shown as a percentage.

Icons Displayed: Battery SOC, Percent Symbol (%), Symbol 2

Mode 2: Automatically Change Display Information

You can select the auto mode by holding down the **A Button** for 3 seconds.

The display shows the same information as in Mode 1 but changes the display automatically every 8 seconds between following information:

Battery 1: Voltage; PV Charging Current; Battery State of Charge (SOC)

Battery 2: Voltage; PV Charging Current; Battery State of Charge (SOC)

If Battery 2 is not connected, the Controller changes only the information for Battery 1.

7.6 Errors

Over Voltage

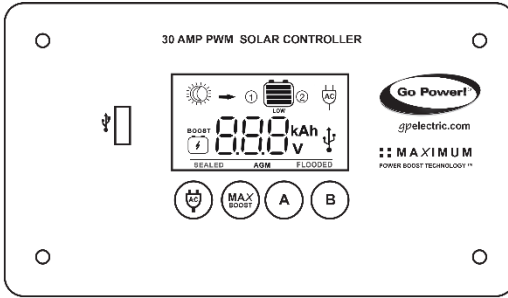

If the GP-PWM-30 experiences a battery over voltage (15.5V) on battery 1, the controller will stop operating and the display will begin to flash with all icons. The controller will resume operating when the error is cleared.

Icons Displayed: All symbols

NOTE

The controller does not display over voltage on battery 2.

Low Voltage

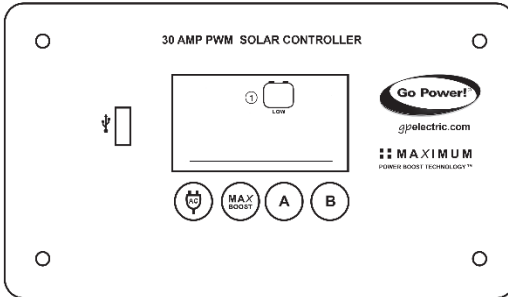



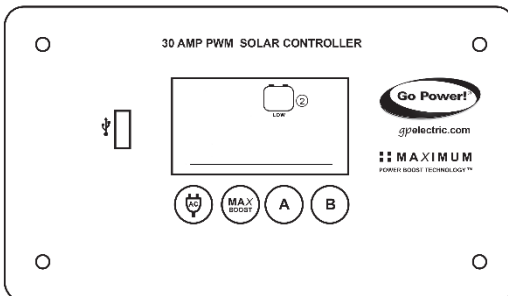





Low battery 1: If the voltage of battery 1 reaches 0%, the battery SOC symbol will show the text “LOW” beneath it. The controller will continue operating in this condition and will only stop operating if the voltage of Battery 1 drops below 6 volts.

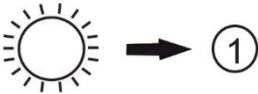



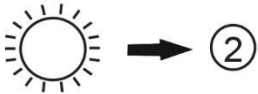



Low battery 2: If the voltage of battery 2 reaches 0 %, the battery SOC symbol will show the text “LOW” beneath it. The controller will continue operating in this condition and will only stop operating if the voltage of Battery 1 drops below 6 volts (this is because the GP-PWM-30 is powered by Battery 1).

Icons Displayed: Battery SOC Symbol, LOW, Symbol 1 or 2

8.0 Display Symbols

Symbol	Indicator For:
Battery 1	
	Day Time: PV Charge Current
	Night Time
	Battery Voltage
	Battery State of Charge
SEALED	Sealed/Gel
AGM	AGM
FLOODED	Flooded
Battery 2	
	Day Time: PV Charge Current
	Night Time
	Battery Voltage
	Battery State of Charge
SEALED	Sealed/Gel
AGM	AGM
FLOODED	Flooded

Other Symbols	
	USB charger on (When charger is off, no symbol will show)
	Inverter on (When inverter is off, no symbol will show)
BOOST	Controller tries to keep battery at Boost Voltage or higher
LOW	Battery 1 / 2 voltage is lower than 11.0V
Whole display will start to blink	Battery 1 voltage > 15.5V
No Symbol	Battery 2 voltage >15.5V
Battery State of Charge	
Symbol	Battery Voltage
	Shows only after full Boost or Equalization Cycle
	>= 12.6V
	>= 11.8 -12.6V
	> 11.0 -11.8V
 LOW	<= 11.0V
100%	Shows only after full Boost or Equalization Cycle
90%	>= 12.8V
$SOC = \frac{batteryvoltage - 11.0V}{1.8V} * 90\%$	< 12.8V and > 11.0V
0%	<= 11.0V

9.0 Inverter Control (on/off)

The following Go Power!® inverters can be turned on/off through the GP-PWM-30 when a modular 6p4c RJ11 type connector is used (included with an optional Go Power!® inverter remote):

- GP-SW1000-12
- GP-SW1000-24
- GP-HS1500-12
- GP-SW2000-12
- GP-SW2000-24
- GP-SW3000-12
- GP-SW3000-24

*The GP-SW1500 Inverter is not compatible.

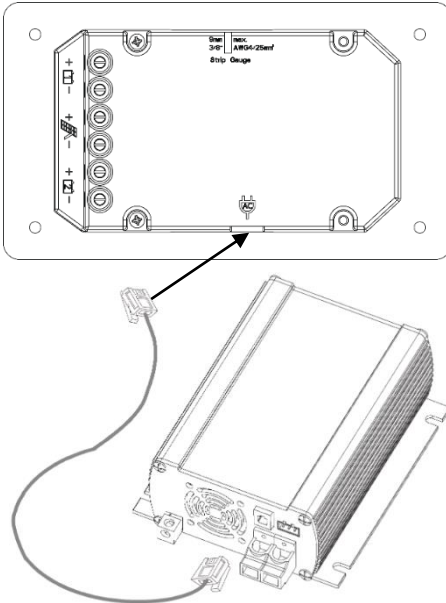

First, connect the inverter directly to the battery (follow the installation instructions included with the inverter).

Then, connect the modular cable (found in the inverter remote box) to the remote terminal of the inverter and and to the remote terminal of the GP-PWM-30 (marked with an **AC Plug symbol**).

Please change the switch of the inverter to Position 2 (Remote controlled).

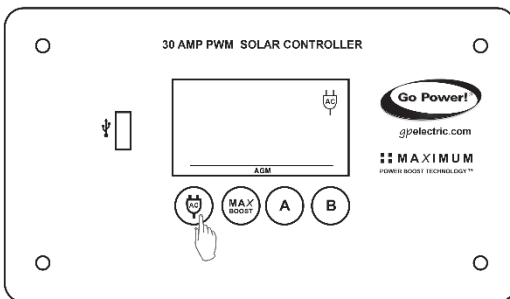

Now, you can enable /disable the connected inverter by holding down the **AC Symbol Button** for 3 seconds.

The inverter is enabled when the **AC plug symbol** appears on the display and is disabled when it disappears.

10.0 USB Charging

The GP-PWM-30 offers a standard USB connector for delivering 5V to small mobile appliances such as cell phones, tablets, small music players. This charging port is capable of supplying up to 800 mA of current.

Remove the rubber cover of the USB terminal to access the terminal.

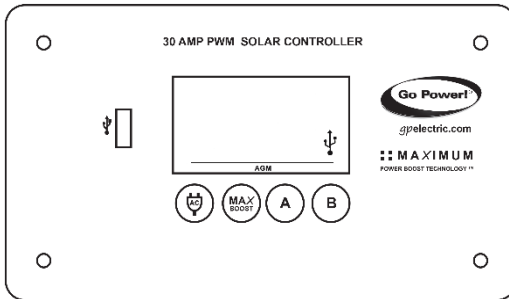

The USB charging port is always active when the **USB symbol** appears on the display.

Battery 1, connected to the Battery 1 terminals, supplies the power for the USB charger.

The controller disables the USB charger automatically if the battery 1 voltage drops below 11.0V. If there is enough current from the PV panel/array available to charge Battery 1 to above 12.8V, the USB terminal will be enabled again.

Warning: Do not connect the charging device anywhere else! USB-Negative contact is connected to battery negative

11.0 Frequently Asked Questions (FAQs)

Before a problem is suspected with the system, read this section. There are numerous events that may appear as problems but are in fact perfectly normal. Please visit gpelectric.com for the most up-to-date FAQs.

It seems like my flooded batteries are losing water over time.

Flooded batteries may need to have distilled water added periodically to replace fluid loss during charging. Excessive water loss during a short period of time indicates the possibility of overcharging or aging batteries.

When charging, my flooded batteries are emitting gas.

During charging, hydrogen gas is generated within the battery. The gas bubbles stir the battery acid allowing it to receive a more full state of charge. **Important: Ensure batteries are in a well-ventilated space.**

My voltmeter shows a different reading than the GP-PWM-30 display

The meter value on the GP-PWM-30 display is an approximate reading intended for indication purposes only. There is an approximate 0.1 volt inherent error present that may be accentuated when compared with readings from another voltmeter.

There may be a slight difference between the battery voltage displayed on the GP-PWM-30 display and the battery voltage measured at the battery terminals. When troubleshooting using a voltmeter, check both the battery voltage at the GP-PWM-30 controller terminals and battery voltage at the battery terminals. If a difference of more than 0.5 volts is noted, this indicates a large voltage drop possibly caused by loose connections, long wire runs, small wire gauge, faulty wiring, a faulty voltmeter or all the above. Consult the Suggested Minimum Wire Gauge chart in **Section 5** for wiring suggestions and check all connections.

12.0 Troubleshooting Problems

How to Read this Section

Troubleshooting Problems is split into three sub-sections, grouped by symptoms involving key components. Components considered irrelevant in a diagnosis are denoted 'Not Applicable' (N/A). A multimeter or voltmeter may be required for some procedures listed.

It is imperative all electrical precautions stated in the Warning Section and outlined in the Installation Section are followed. Even if it appears the system is not functioning, it should be treated as a fully functioning system generating live power.

12.1 Problems with the Display

Display Reading: Blank

Time of Day: Daytime/Nighttime

Possible Causes:

Battery or fuse connection and/or solar array connection (Daytime only) or battery or fuse connection (Nighttime only).

How to tell:

1. Check the voltage at the controller battery terminals with a voltmeter and compare with a voltage reading at the battery terminals.
2. If there is no voltage reading at the controller battery terminals, the problem is in the wiring between the battery and the controller. If the battery voltage is lower than 6 volts the controller will not function.
3. For the solar array, repeat steps 1 and 2 substituting all battery terminals with solar array terminals.

Remedy:

Check all connections from the controller to the battery including checking for correct wire polarity. Check that all connections are clean, tight, and secure. Ensure the battery voltage is above 6 volts.

Display Reading: Nighttime

Time of Day: Daytime

Possible Causes:

Panel is covered by something; PV panel is too dirty to supply a high enough voltage to charge the battery; PV panel is not connected.

Remedy:

Check the panel and to ensure it is not obscured. Clean the panel if it is dirty. Check that PV cables are connected to the controller.

12.2 Problems with Voltage

Voltage Reading: Inaccurate

Time of Day: Daytime/Nighttime

Possible Cause:

Excessive voltage drop from batteries to controller due to loose connections, small wire gauge or both.

How to tell:

1. Check the voltage at the controller battery terminals with a voltmeter and compare with the voltage reading at the battery terminals.
2. If there is a voltage discrepancy of more than 0.5 V, there is an excessive voltage drop.

Remedy:

Check all connections from the controller to the battery including checking for correct wire polarity. Check that all connections are clean, tight, and secure. Shorten the distance from the controller to battery or obtain larger gauge wire. It is also possible to double up the existing gauge wire (i.e. two wire runs) to simulate a larger gauge wire.

12.3 Problems with Current

Current Reading: 0 A

Time of Day: Daytime, clear sunny skies

Possible Cause:

Current is being limited below 1 Amp as per normal operation or poor connection between solar array and controller.

How to tell:

1. The State of Charge (SOC) screen is close to 100% and the Sun and Battery icon are present with an arrow between.
2. With the solar array in sunlight, check the voltage at the controller solar array terminals with a voltmeter.
3. If there is no reading at the controller solar array terminals, the problem is somewhere in the wiring from the solar array to the controller.

Remedy:

1. Hold down the MAX BOOST Button for approximately 3 seconds to activate Maximum Power Boost. This will allow the controller to charge batteries to 14.4 +/- 0.1V (14.4 +/- 0.1V Sealed/Gel) with all current the solar array is producing.
2. Check all connections from the controller to the array including checking for correct wire polarity. Check that all connections are clean, tight, and secure. Continue with the solutions below for additional help on low current readings.

Current Reading: Less than expected

Time of Day: Daytime, clear sunny skies

Possible Causes:

- (1) Current is being limited below 1 Amp as per normal operation.
- (2) Incorrect series/parallel configuration and/or wiring connections and/or wire gauge.
- (3) Dirty or shaded module or lack of sun.
- (4) Blown diode in solar module when two or more modules are connected in parallel.

How to tell:

- (1) Battery State of Charge screen is close to 100% and the Sun and Battery icon are present with an arrow in between.
- (2) Check that the modules and batteries are configured correctly. Check all wiring connections.
- (3) Modules look dirty, overhead object is shading modules or it is an overcast day in which a shadow cannot be cast.

NOTE

Avoid any shading no matter how small. An object as small as a broomstick held across the solar module may cause the power output to be reduced. Overcast days may also cut the power output of the module.

- (4) Disconnect one or both array wires from the controller. Take a voltage reading between the positive and negative array wire. A single

12 volt module should have an open circuit voltage between 17 and 22 volts. If you have more than one solar module, you will need to conduct this test between the positive and negative terminals of each module junction box with either the positive or the negative wires disconnected from the terminal.

Remedy:

(2) Reconnect in correct configuration. Tighten all connections. Check wire gauge and length of wire run. Refer to Suggested Minimum Wire Gauge in **Section 5**.

(3) Clean modules, clear obstruction or wait for conditions to clear.

(4) If the open circuit voltage of a non-connected 12 volt module is lower than the manufacturer's specifications, the module may be faulty. Check for blown diodes in the solar module junction box, which may be shorting the power output of module.

13.0 Limited Warranty

1. Carmanah warrants the GP-PWM-30 for a period of five (5) years from the date of shipment from its factory. This warranty is valid against defects in materials and workmanship for the five (5) year warranty period. It is not valid against defects resulting from, but not limited to:
 - Misuse and/or abuse, neglect or accident
 - Exceeding the unit's design limits
 - Improper installation, including, but not limited to, improper environmental protection and improper hook-up
 - Acts of God, including lightning, floods, earthquakes, fire, and high winds
 - Damage in handling, including damage encountered during shipment

2. This warranty shall be considered void if the warranted product is in any way opened or altered. The warranty will be void if any eyelet, rivets, or other fasteners used to seal the unit are removed or altered, or if the unit's serial number is in any way removed, altered, replaced, defaced, or rendered illegible.

13.1 *Repair and Return Information*

Visit www.gpelectric.com to read the “frequently asked questions” section of our website to troubleshoot the problem. If trouble persists:

1. Call your Go Power!® Technical Support team (1-866-247-6527).
2. Return defective product to place of purchase

14.0 Installation Template

Use the template on page 27 for flush mounting the controller.

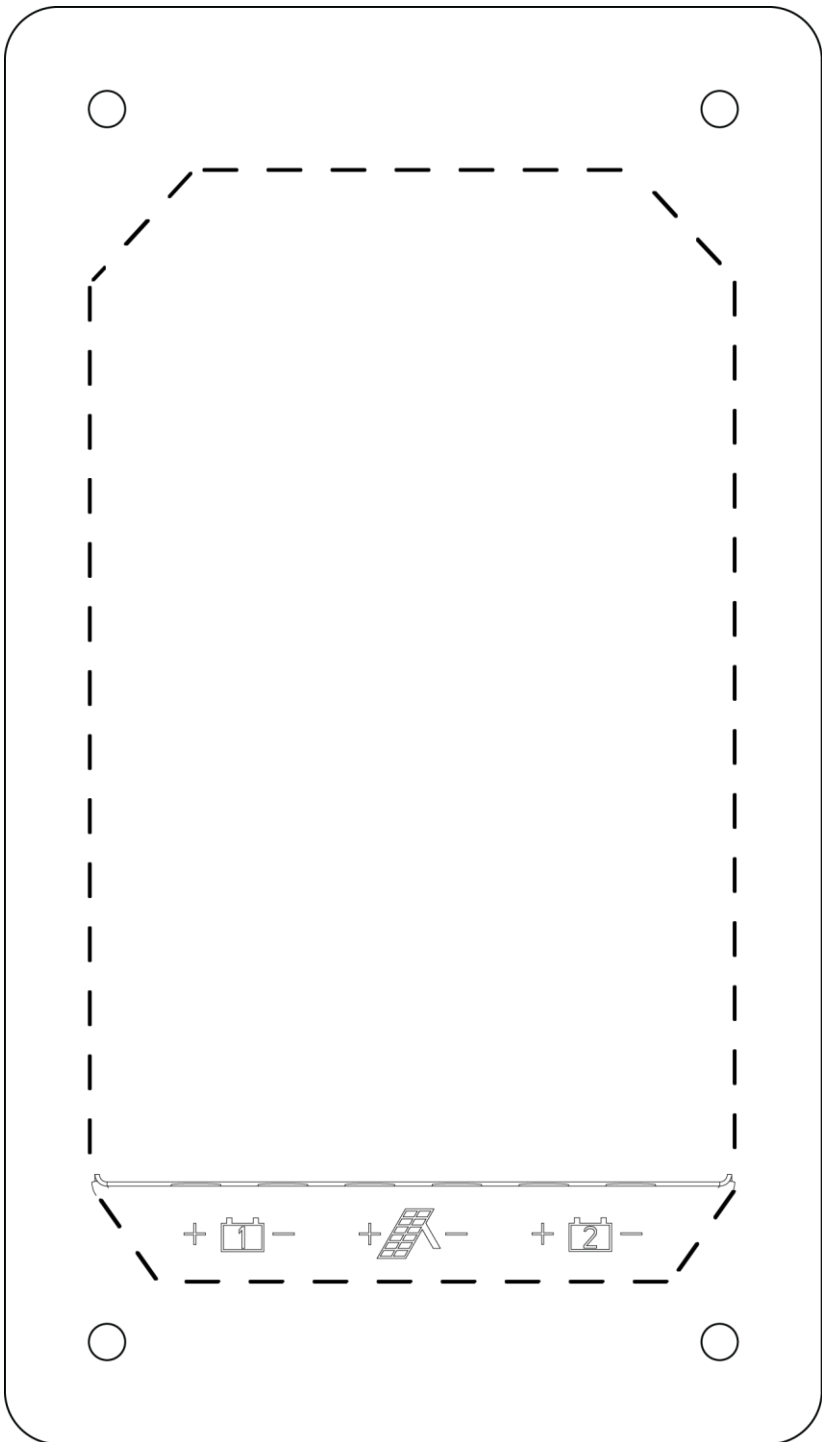



© 2015 GO POWER!® By Carmanah Technologies

MOBI_MAN_GP-PWM-30_vD

gpelectric.com