



GUIDEBOOK TO ENJOYMENT OF
YOUR KZRV, L.P.
RECREATIONAL VEHICLE

MXT

THE PURPOSE OF THE KZRV OWNER'S MANUAL IS TO PROVIDE THE MOST CURRENT INFORMATION AVAILABLE CONCERNING KZRV RECREATIONAL VEHICLES. OPERATION AND MINOR MAINTENANCE IS THE MAIN FOCUS OF THIS BOOK.

MAINTENANCE OF YOUR RECREATIONAL VEHICLE IS IMPORTANT TO KEEPING YOUR COACH IN GOOD CONDITION. FAILING TO PROVIDE MAINTENANCE, AS SUGGESTED, COULD RESULT IN LOSS OF WARRANTY COVERAGE. REVIEW THE COPY OF YOUR KZRV TOWABLE TRANSFERABLE LIMITED WARRANTY, WHICH HAS BEEN SUPPLIED TO YOU WITH YOUR WARRANTY REGISTRATION FORM.

ADDITIONAL MANUALS MAY BE SUPPLIED AND AVAILABLE BY THE MANUFACTURER OF THE COMPONENT AND/OR APPLIANCE. SEE THE INFORMATION PACKET IN YOUR COACH.

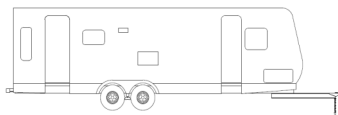

Conventional Travel Trailer

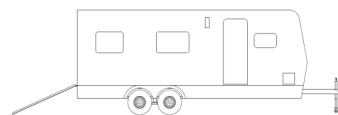

Travel Trailer Toy Hauler

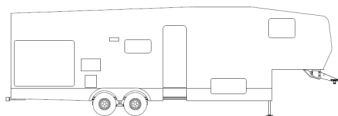

Conventional Fifth Wheel

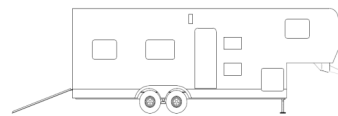

Fifth Wheel Toy Hauler

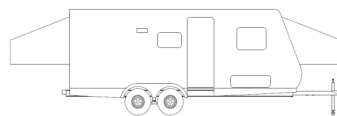

Hybrid Travel Trailer

KZRV, L.P.
**“BUILDING QUALITY AND FUN
FOR OVER 40 YEARS”**

We congratulate you on your purchase of a KZRV, recreational vehicle. You have chosen a quality built RV which should provide you with many years of camping memories and fun.

The recreational vehicle you have purchased has been inspected by our trained inspectors and fully meets our high quality standards.

As the owner of a new KZRV, RV you can rest assured that we will do all we can to keep you a “happy camper”. Naturally, your selling dealership is always happy to help you with any questions you may have or service you may need. And should you need assistance when traveling, with over 200 KZRV, dealers nationwide, assistance is usually just minutes away.



KZRV, L.P.
0985 N 900 W
Shipshewana, IN 46565

TABLE OF CONTENTS

Chapter 1 – Introduction to RV Ownership	1
Safety Considerations	2
Reporting Safety Defects	2
Safety When Emergency Stopping	3
Additional Safety Considerations	3
Extended or Cold Weather Use	4
Condensation	5
Causes	5
Solutions	5
Interior Ventilation	6
Chapter 2 – Service Procedures	7
Basic Service Procedures	7
Dealer	8
Factory	8
Parts	8
Owner’s Responsibility	8
Seasonal Site	9
Towable Limited Warranty	10
Chapter 3 – Using Your RV	13
Equipment	13
Tow Vehicle	13
Hitches – Travel Trailer	13
Hitch Height Specifications – Travel Trailer	14
Hook-Up (Travel Trailer)	14
The Safety Chain (Travel Trailer)	15
Traveling	16
Weights	16
Weighing Vehicle (Loaded or Unloaded)	17
Loading the Trailer—Distribution	18
Toy Hauler-Cargo Information	19
Interior, Cargo Area	21
Rear Screen Door	21
Rear Cargo Door	21
Fuel Cell	22
Towing	23
Tires	24
Safety First-Basic Tire Maintenance	25
Finding Tire Pressure and Load Limits	25
Understanding Tire Pressure and Load Limits	26
Checking Tire Pressure	26
Steps for Maintaining Proper Tire Pressure	27
Tire Size	27

Tire Tread.....	27
Tire Balance and Wheel Alignment.....	28
Tire Repair.....	28
Tire Fundamentals.....	28
Additional Information on Light Truck Tires.....	29
Vehicle Load Limits.....	30
Cargo Capacities.....	30
How Overloading Affects Your RV and Tires.....	31
Tire Safety Tips.....	31
Preventing Tire Damage.....	31
Tire Safety Checklist.....	32
How to Change a Tire.....	32
Wheel Lugs.....	32
Brakes—Electrical.....	32
Breakaway Switch.....	34
Fire Extinguisher.....	34
Setting Up and Using Your Recreational Vehicle.....	35
Travel Trailer Hook Up.....	35
Safety Detectors.....	37
Propane/ Carbon Monoxide Detector.....	37
What is Carbon Monoxide?.....	37
Dual Sensor Technology.....	37
Operation.....	38
Lower Power Option.....	38
Visual and Audible Alarm Signals.....	39
CO Alarm.....	39
Propane Gas Alarm.....	39
Smoke Alarm.....	40
Operation.....	40
False Alarm “Mute” Control.....	40
Testing.....	40
General Detector Information.....	41
Steps-Two or Three.....	41
Windows.....	42
Doors.....	42
TV Antennas (Standard Roof Mount).....	42
Slide Outs.....	43
Power For Operation.....	44
Trailer Set-Up Requirements-General.....	45
Below Floor Slide System.....	46
Above Floor Slide Out (All Brands and Types).....	46
Electrical Components.....	46
Manual Override.....	47
Below Floor Slide Out.....	47
Above Floor Slide Out.....	47

King Slide Cable System.....	47
Manually Moving the King Slide Room.....	48
Bunk Doors.....	48
Tent Assembly.....	48
Important Information On Your Tent.....	49
Tent Shrinkage.....	50
Cleaning Your Tent.....	50
Interior Bunks.....	50
Chapter 4 – Systems	51
Water and Drainage Plumbing	51
Fresh Water System.....	51
Tanks.....	51
Filling Fresh Water System.....	51
12-Volt Demand Pump	53
Faucets.....	53
Bath and Shower	53
Outside Spray Port	54
Fresh Water Lines.....	54
Lo-Point Drains.....	54
Sanitizing and Filling the Potable Water System.....	55
For Direct Fill-City Water or Storage Tank.....	55
Drainage (Fresh Water).....	56
Sanitation System	56
Toilets.....	56
Using Toilet and Tank System.....	57
Vents.....	57
Holding Tanks.....	58
Draining the Tanks.....	59
Flush System.....	59
Maintenance for Holding Tanks.....	60
Heated Holding Tanks.....	60
Winterizing Your Recreational Vehicle	60
Propane Fuel System.....	63
Propane Container.....	63
Servicing and Filling Propane Containers	64
Installing Propane Containers	66
Regulator.....	67
High Pressure Hoses with Acme Connectors.....	69
Main Supply Hose – Low Pressure	69
Operation.....	70
Checking for Leaks	70
Propane Consumption	71
Electrical System.....	73
General Information	73
Changes and Modifications	73

120 Volt AC System.....	73
Power Cord 30 Amp or 50 Amp.....	73
Circuit Breakers and Box	74
50 Amp (Optional)	75
GFCI Protection.....	77
12 Volt DC System	77
Converter.....	78
Auxiliary Battery (Optional on Some Units).....	78
Circuit Breakers and Fuses-12Volt DC	79
Exterior Lights and Connector, 12V	81
Porch Lights.....	81
Brake Wiring.....	81
Chapter 5 – Appliances.....	83
Furnace.....	83
Operating Instructions.....	84
What To Do If You Smell Propane.....	85
Turn Off Propane To Appliance.....	86
External Vents.....	86
Ducting.....	87
Range and Oven Top Burner Operation	88
Operating Instructions.....	88
Top Burners.....	88
Oven Burner.....	90
What To Do If You Smell Propane.....	91
Water Heater.....	92
Safety Items.....	92
Operating Instructions: Propane.....	93
What To Do If You Smell Propane	93
Operating Instructions For Direct Spark Ignition.....	94
Operating Instructions: Electric Elements	95
To Turn Off Water Heater.....	95
Winterizing Your Water Heater	95
Refrigerator.....	96
Leveling.....	96
Operation During Travel.....	96
Venting.....	96
Moisture Reduction Heater	96
Door Sealing.....	97
Door Handles.....	97
Refrigerator Storage.....	98
Operating The Refrigerator Controls.....	98
Monitor Panel.....	99

CHAPTER 1 INTRODUCTION TO RV OWNERSHIP

Welcome to the growing family of new KZRV owners and the world of recreational vehicle travel. The purchase of your KZRV product allows you to enter this type of camping and leisure travel. Your coach has been designed and engineered to offer many comforts of home. KZ Recreational Vehicles are designed and constructed to be used as temporary living quarters for camping and travel uses. The coaches are not intended for hauling cargo.

This owner's manual was prepared to assist you in understanding the proper use and operation of various containment systems, servicing and maintenance of component parts, and explanation of your warranty protection. If this is your first RV travel coach, you will want to acquaint yourself with all aspects and information found in this manual plus manuals supplied by component manufacturers.

These materials will reflect the most current information available for the user. Some components and items may not be in your coach as they may be options on different models.

Keep this owner's manual in your recreational vehicle for handy reference. Get to know your new vehicle and how it operates. You should carefully read and understand these instructions, as well as information supplied by the manufacturers of separately warranted products, since they contain important operating, safety, and maintenance instructions. If you have questions that are not adequately answered by this manual or other booklets, consult your dealer. If he cannot satisfactorily answer your questions, he will call our staff for additional information.

Every effort has been made to provide you with a safe, dependable product. Your vehicle complies with applicable requirements of Federal Motor Vehicle Safety Standards, State Regulations, Canadian Standards Associations (CSA) where applicable, and complies with requirements of ANSI Standard A119.2, the nationally recognized "Standard for Recreational Vehicles – Installation of Plumbing, Heating and Electrical Systems." The Recreational Vehicle Industry Association (RVIA) and Canadian Standards Association (CSA) periodically inspect our production lines and assist us in maintaining strict compliance with installation and safety standards for those systems. **Your follow-up with periodic safety inspections and a program of preventive maintenance is important for the continuation of safe and trouble-free**

operation.

Camping is a great way to relax and enjoy the outdoors with your friends and family. Please remember to tread lightly on our beautiful land and leave only your footprints so that others may enjoy nature as much as you did.

SAFETY CONSIDERATIONS

The terms **NOTE**, **CAUTION** and **WARNING** have specific meanings in this manual as well as component manuals.

A **NOTE** provides additional information to make a step or procedure easier or clearer. Disregarding a **NOTE** could cause inconvenience, but would not be likely to cause damage or personal injury.

A **CAUTION** emphasizes areas where equipment damage could result. Disregarding a **CAUTION** could cause permanent mechanical damage. However, personal injury is unlikely.

A **WARNING** emphasizes areas where personal injury or even death could result from failure to follow instructions properly. Mechanical damage may also occur.

Reporting Safety Defects

If you believe that your vehicle has a defect which could cause a crash or could cause injury or death, you should immediately inform the National Highway Traffic Safety Administration (NHTSA) in addition to notifying KZRV.

If NHTSA in addition receives similar complaints, it may open an investigation, and if it finds that a safety defect exists in a group of vehicles, it may order a recall and remedy campaign. However, NHTSA cannot become involved in individual problems between you, your dealer or KZRV.

To contact NHTSA, you may either call the Auto Safety Hotline toll-free at 1-800-424-9393 or write to:

NHTSA
US Department of Transportation
Washington, DC 20590

You can also obtain other information about motor vehicle safety from the Hotline.

Safety When Emergency Stopping

It is wise to carry road flags and/or triangular warning devices to be used when necessary. When pulling off a highway, use your four way hazard lights as warning flashers, even if only to change drivers. Pull off the road way completely if at all possible to change flat tires or any other emergency needs.

Additional Safety Considerations

1. Sanitize the fresh water supply system periodically (see sanitizing instructions).
2. Keep water connection fittings from coming in contact with the ground or drain hose to reduce chance of contamination.
3. Enlist services of a Qualified RV Technician to fix gas or electrical appliances.
4. Always have a serviceable fire extinguisher placed in an easily accessible location.
5. Insure that tires are in good condition and properly inflated. Watch tire inflation closely. Under-inflated tires will overheat. Overheated tires are a potential hazard as they may throw rubber and cause a blow-out. Check the tire pressure before each trip while the tires are cold.
6. Check and tighten the wheel lugs regularly (every 50 miles when new until 200 miles are reached and then check the lugs every 500 miles).
7. Check the brakes in a safe area – not while traveling a busy highway.
8. Always block the trailer wheels solidly before unhitching.
9. Before leaving a camp area with a trailer in tow, insure:
 - a. The safety pin or locking lever is seated.
 - b. The breakaway wire is attached to the tow vehicle.
 - c. All jacks are raised so that they cannot touch the ground.
 - d. The 110-volt electrical cord is properly stored.
 - e. The safety chains are connected.
 - f. All interior lights are off.
10. Observe the warning labels attached to your vehicle concerning propane, water, electricity and loading.
11. Extinguish all campfires before leaving your campsite.

EXTENDED OR COLD WEATHER

Your KZ recreational vehicle has been built for enjoyment in a recreational manner. This recreational vehicle is not intended to be used as full time living quarters. Nor is this a four season unit. Using this unit in freezing conditions is not recommended. However, if unit is used in freezing weather, following are guidelines to follow. Any problems resulting from freezing are not covered under warranty.

1. For winter use in freezing conditions, more protection may be required. Use skirting and/or insulation below floor level to provide additional protection.
2. Remember water freezes at 32 degree Fahrenheit whether fresh or drainage. Proper care must be used to protect any system at 32 degree F or lower. Local recreational vehicle dealers and campground personnel may be able to advise you on needed protection.
3. Energy requirements, such as propane and electrical supplies must be adequate. Protect your propane regulator from freeze ups.
4. During cold weather you will experience more condensation then normal. Using ventilation or a dehumidifier may be needed.

CONDENSATION

Where it comes from, what causes it, and various solutions.

Causes:

- A. It occurs when warm moist air contacts a cold surface, such as rain touching a tent, awning fabric with people breathing warm moist air against it from inside due to normal breathing.
- B. When cooking food or taking a shower, warm moist air circulates throughout the coach attaching itself to cooler surfaces, forming beads and running down wall or window.
- C. Normal breathing will emit approximately 1/2 pint of moisture into the air per person, per day. The more occupants the greater quantity of condensation you may find.

Solutions:

- 1. When taking a shower, open bath roof vent approximately 1/2 inch allowing moisture to escape.
- 2. Use the power vent over range when cooking.
- 3. If condensation is found in cabinet or closets, open door slightly to equalize temperature and provide ventilation.
- 4. Opening windows and roof vents, when possible, allowing warm moist air to escape is the best way to reduce condensation.
- 5. Under extreme conditions, you may need to use a dehumidifier to remove moist air conditions.

In camping, coaches which have tents or fabric bunk areas, such as the Rock Climber, it is even more important to avoid condensation drops from roof area.

Opening the tent window at the person's head will allow air to flow across roof reducing or avoiding condensation.

Uncontrolled condensation can cause dampness, mildew, etc., inside your recreational vehicle. Be sure to make strong efforts to control condensation.



INTERIOR VENTILATION

A new coach always has a peculiar aroma in it due to all the components used to build it, such as paneling, plywood, carpet and fabrics.

Allowing fresh air to move and circulate throughout a new recreational vehicle is very valuable for several reasons.

1. Components used to build RV's always have a "new" smell to them, possibly irritating the respiratory system of the human body on warm days.
2. Fresh air is always good for the human body unless allergies are a factor.

Numerous ways are provided to exchange air in coaches.

1. Open windows on non-rainy days, allowing air exchange between inside and outside.
2. Power hood vent above cooking stove will send heat and food smell outside.
3. Roof vent; numerous types;
 - A. Standard air flow using gravity flow method.
 - B. Power (12v or 110V) vents will move air faster.
 - C. Hi-volume power vents, operation in 12 volt power can exchange air in a coach in several minutes if windows are open accordingly. If there is a fan in the rear, open window(s) in front.

Different brands/models have different features, such as remote control, rain sensor, variable speed control switch, etc.

Read carefully the operating instructions which are provided by the manufacture which can be found in your coach.

CHAPTER 2 SERVICE PROCEDURES

BASIC SERVICE PROCEDURES

Both KZRV and Your KZRV Dealer has a strong and dedicated interest in maintaining the highest quality customer relations with its owners. Your satisfaction with your KZ recreational vehicle and your KZRV dealer is our primary concern. By producing high quality products, we want to assure our customers of our support with parts and service availability. **Our dealer network is the first choice to serve and supply your needs for your recreational vehicle.** Our authorized dealers will pleasantly assist in providing service maintenance needs plus parts, options, and information concerning your recreational vehicle.

Should you experience a problem with service availability, please follow the steps in the order listed below.

1. Contact your selling dealer's service department for an appointment. Describe to the best of your knowledge the nature of the problem. Please keep appointments to establish a good, workable relationship.
2. Contact the owner or general manager of the dealership should the initial attempt fail with the service department.
3. Contact:
Customer Relations Department
KZRV
0985 N 900 W
Shipshewana, IN 46565

Phone: (260)768-2058

E-mail: kz@kz-rv.com
Website: <http://www.kz-rv.com>

Give all the above information as requested along with the serial number of the coach in question. We will make every attempt to resolve your problem.

Please bear in mind that most problems arise from misunderstandings concerning warranty coverage and service. In most instances, you will be referred to the dealer level and your concerns will be resolved with the dealer's facilities and personnel.

Dealer

Your authorized KZRV dealer has performed a PDI (pre-delivery inspection) on your recreational vehicle. Since your dealer is authorized to sell KZRV products, They are also there to supply parts, optional equipment, and provide service repairs, warranty or otherwise as needed.

First choice for warranty repairs is your selling KZRV dealer. Other dealers can be used, however, prior approval is required.

Some recreational vehicle dealers may be authorized service centers for certain manufacturers of products warranted separately, such as appliances. Check with your dealer before contacting anyone else to reduce delays. If the dealer is not an authorized service center for the product in question, he can assist you in obtaining authorized service.

Factory

Service repairs can be performed at the manufacturing facility at Shipshewana, Indiana. Should your KZRV product be in need of major repairs and your dealer recommends factory repairs, please follow the steps listed below for such work.

1. Your dealer **must** make an appointment with service personnel at the factory PRIOR to your arrival.
2. Any freight costs are the responsibility of the owner as listed in the warranty coverage schedule.

Parts

Stocking of parts varies from dealer to dealer. Any authorized dealer can order any required part to be shipped to their dealership. All parts are obtained through authorized KZRV dealers only.

Owner's Responsibility

When owning and using a recreational vehicle, it is important to perform regular and normal maintenance. This is recommended twice a year, spring and fall, to prevent undesired deterioration of your coach. Weather elements play an important function on sealants and other components requiring normal maintenance.

As an owner and operator, it is your responsibility and obligation to inspect and return your coach to an authorized dealer for repairs as required. Your authorized selling dealer is always your first choice and he certainly has continued interest in your satisfaction. As your manufacturer, we recommend that inspection and service be performed by your selling dealership.

If you are traveling and are unable to locate an authorized KZ dealer, or an authorized dealer for the component needing service, please call our customer service office at (260)768-4016. Service at a non-authorized dealer MUST have prior authorization. You may be asked to return any mechanical parts that were replaced before reimbursement consideration is made. Unauthorized or improper repairs may void the warranty of that component. Always keep your owner's manual along with a copy of your warranty registration with you when traveling.

Season Site

When placing your unit on a camp site in the spring and returning it in the fall to your home, it's classed as a "seasonal site."

Performing repair work on such a site is not recommended for numerous reasons; available parts, tools, space, weather conditions, etc.

Any service repairs which require a service technician also require the unit to be taken to a service facility, preferably your selling dealer.

Warranty coverage does not include trip or service call costs for such a trip. It is the owners responsibility to provide for such costs.

TOWABLE LIMITED WARRANTY

Two Year Limited Warranty

SUMMARY OF WARRANTY: KZRV warrants the structure of every towable recreational vehicle or truck camper purchased from an authorized KZRV dealer to the first retail consumer for a period of two (2) years, to be free from substantial defects in materials and workmanship when used for its intended purpose. The warranty period begins on the date of purchase or the date the unit is first placed in service, whichever is earlier. For purposes of this Towable Limited Warranty ["TLW"], the term "structure" includes the interior and exterior sidewalls, floor, roof, and frame.

EXCLUSIONS FROM WARRANTY: Excluded from coverage under the TLW are: (1) items added, changed, or modified after the unit left the possession of KZRV; (2) units used for any commercial purpose; (3) units used for full-time residential use or more than occasional recreational use; (4) wear and tear caused by normal usage by the consumer, including but not limited to fading or discoloration of soft goods [e.g., tents, upholstery, drapes, carpet, vinyl, screens, cushions, and mattresses], fading or discoloration of exterior or fiberglass components, tears, punctures, soiling, mildew, mold, and the effects of moisture condensation inside the unit; (5) the effects of alteration, tampering, mishandling, neglect, abuse, misuse, weather, acts of nature, acts of God, or corrosive atmospheres that promote rusting, oxidation, or pitting; (6) minor imperfections that do not interfere or affect the suitability of the unit for its intended use; (7) the effects of consumer's or transferee's failure to perform normal and routine maintenance [e.g., inspections, lubrication, adjustments, tightening of screws and bolts, tightening of lug nuts and wheels, sealing, rotating, cleaning, or other damages resulting from failing to follow the maintenance schedule and procedures in the owners manual; (8) damages resulting from misalignment or adjustments to axles or spindles caused by improper maintenance, modification, loading, unloading, road hazards, road defects, off road travel, or tire failures; (9) damages caused by the negligent or intentional use or misuse of the unit by the consumer or transferee, including but not limited to occurrences while towing the unit; (10) claims made for alignment or adjustment of patio doors [Note: any unit with a patio door is not intended to be towed like a travel trailer, and must be permanently parked on a lot. If such a unit is towed this TLW is voided in regard to the patio door and the surrounding structures]; (11) loss or damage caused by a person or business as a result of transporting the unit after sale to the consumer, delivering the unit, or parking the unit; (12) loss or damage to the plumbing system caused by freezing; (13) claims for personal injuries of any type; (14) costs of transportation of the unit for repairs; and (15) components that are warranted separately by another manufacturer [the warranty provided by a component manufacturer is the sole responsibility of that manufacturer, and KZRV does not warrant those components. Please refer to the warranties issued by the component manufacturers for the terms and conditions of such warranties].

TO OBTAIN WARRANTY SERVICE: Warranty service may be performed only at KZRV, or at KZRV authorized dealers and service centers. Contact KZRV for a list of authorized dealers and service centers. REPAIRS OR REPLACEMENTS BY

UNAUTHORIZED DEALERS OR SERVICE CENTERS WILL VOID THIS TLW. If the consumer believes that a claimed defect is covered by this TLW, contact must be made with an authorized dealer or service center WITHIN THE WARRANTY PERIOD. Sufficient information must be given to attempt to resolve the claimed problem. Should KZRV determine that repair or replacement is appropriate, the consumer must deliver the unit to the dealer or service center as directed. Delivery shall occur no later than thirty (30) days after the authorization for repair or replacement. Do not deliver your unit to KZRV, an authorized dealer, or service center without prior authorization. All costs incurred by the consumer for transportation for warranty service shall be the sole responsibility of the consumer. The dealer or service center shall repair or replace any warranted defect within a reasonable time, but no later than ninety (90) days after delivery by the consumer. Should the unit not be repaired or replaced within said period of time, then the consumer must contact KZRV by CERTIFIED MAIL with a written description of the claimed warranted defect and the efforts to remedy it. FAILURE TO SO NOTIFY KZRV IN THIS REGARD SHALL RENDER THIS TLW VOID AS TO THE CLAIMED DEFECT. After receipt of such notice, KZRV shall repair or replace such warranted defect within a reasonable time, but not later than ninety (90) days after delivery by the consumer. The scheduling of warranty work at an authorized dealer or service center is not controlled by KZRV and delays may be experienced. KZRV is not responsible for loss of use of the unit, expenses for fuel, telephone, food, lodging, travel, loss of income or revenue, or loss of or damage to personal property.

DISCLAIMER AND LIMITATIONS OF WARRANTIES: NEITHER KZRV NOR ITS DEALERS SHALL BE LIABLE FOR INCIDENTAL, CONSEQUENTIAL, INDIRECT, SPECIAL, OR PUNITIVE DAMAGES OF ANY KIND OR ANY OTHER FINANCIAL LOSS ARISING OUT OF OR IN CONNECTION WITH THE SALE OR USE OF THIS PRODUCT, WHETHER BASED IN CONTRACT, TORT, STRICT LIABILITY, EQUITY, OR ANY OTHER THEORY, EVEN IF KZRV HAS BEEN ADVISED OF THE POSSIBILITY OF SUCH DAMAGES. KZRV'S ENTIRE LIABILITY SHALL BE LIMITED TO REPAIR OR REPLACEMENT, AT KZRV'S SOLE OPTION.

THE UNITED NATIONS CONVENTION ON CONTRACTS FOR THE INTERNATIONAL SALE OF GOODS IS HEREBY EXCLUDED IN ITS ENTIRETY FROM APPLICATION TO THIS TLW.

THIS TLW, AND THE REMEDIES HEREUNDER, ARE EXCLUSIVE AND IN LIEU OF ALL OTHER WARRANTIES, EXPRESS OR IMPLIED, INCLUDING WARRANTIES OF MERCHANTABILITY, FITNESS FOR A PARTICULAR PURPOSE, CORRESPONDENCE WITH DESCRIPTION, AND NON-INFRINGEMENT, ALL OF WHICH ARE EXPRESSLY DISCLAIMED BY KZRV. THIS TLW GIVES YOU SPECIFIC LEGAL RIGHTS AND YOU MAY ALSO HAVE OTHER RIGHTS THAT VARY DEPENDING ON LOCAL LAW. SOME STATES LIMIT OR PROHIBIT LIMITATIONS OF WARRANTIES, SO THE ABOVE MAY NOT APPLY TO YOU. YOU SHOULD CONSULT A COMPETENT ATTORNEY FOR LEGAL ADVICE.

MISCELLANEOUS: No repair or replacement effected shall cause any extension or renewal of the warranty period. KZRV may make parts and/or design changes from time to time without notice and repairs or replacements may be made with new or different parts. KZRV reserves the right to make changes in the design or material of its products without incurring any obligation to incorporate such changes in any product previously manufactured. At KZRV's, sole option, any dispute concerning any warranted defect may be resolved through mediation or arbitration. This TLW shall be governed by the laws of the State of Indiana, and any legal action shall be brought only in the Circuit or Superior Court of LaGrange County, Indiana.

WARRANTY REGISTRATION AND CONTACT INFORMATION: The warranty registrations for component parts should be completed and delivered in accordance with the instructions contained therein. The TLW registration must be completed and returned to KZRV within fifteen (15) days of delivery of the unit to the consumer. Failure to do so can void this TLW or cause delays in obtaining benefits. The TLW registration, and all inquiries, must be directed to: KZRV, L.P., Warranty Department, 0985 N 900W, Shipshewana, Indiana 46565, Telephone: (260) 768-4016.

I HEREBY ACKNOWLEDGE THAT I HAVE RECEIVED, READ, AND UNDERSTAND THIS TOWABLE LIMITED WARRANTY, AND THAT I HAVE INSPECTED THE UNIT AND FIND IT IN THE CONDITION REPRESENTED.

Date: _____
Purchaser

CHAPTER 3 USING YOUR RV

In this chapter you will find three areas of useful information to assist you with correct **equipment**, **traveling**, and finally, actually **using your recreational vehicle**.

EQUIPMENT

Tow Vehicle

Begin your camping experiences by obtaining a tow vehicle which will adequately transport your recreational vehicle to and from your chosen destinations. Your most important measuring tool is the GVWR, Gross Vehicle Weight Rating, to cross match the capability of your selected tow vehicle.

Ford, Chrysler, and Chevrolet provide trailer towing guides for their products, as do most auto or truck manufacturers. Ask your local automotive dealer for a copy or call the factory's direct lines for information. Many tow vehicles, including mini-vans, have special towing package options available for small travel trailers. Tow vehicles with long wheel bases perform better than those with short wheel bases.

A second factor is GCWR, Gross Combined Weight Rating, which refers to the total weight of the tow vehicle and any vehicle in tow as a "combined" weight. This information, supplied by the tow vehicle manufacturer, is related to the capability of the tow vehicle.

The condition of the suspension in your tow vehicle is also an important factor. Make sure your tow vehicle is in good operating condition and follow the factory recommended maintenance guidelines.

Hitches – Travel Trailer

After obtaining your tow vehicle, it is very important to choose, and have installed, a correct hitch system with weight distributing bars to accommodate your coach if so required. This selection and installation should be done by a professional hitch service center, which may or may not be your selling dealer.

Weight distributing hitches apply leverage between the tow vehicle

and trailer. This assists in equalizing the weight between vehicles, resulting in both vehicles traveling level. The condition of the tow vehicle's suspension system will affect the towing performance capability of your equipment.

Optional sway controls are also helpful with travel towing, especially long and heavy tongue weight coaches.

 **CAUTION**

Trailers with tandem axles need to travel as level as possible, avoiding different weights on each axle plus handling conditions.

 **CAUTION**

Using an oversized or undersized hitch can cause damage to the frame of your travel trailer or tow vehicle.

Hitch Height Specifications – Travel Trailer

Due to axles being either straight or drop bars, the ball height will vary. To find the correct height for ball hitch, set your trailer on a flat surface in level position. Measure from the inside of the ball socket to the ground, approximately 18 to 22 inches as shown, for correct spacing. You may wish to add 1 to 2 inch to this amount to compensate for sag of suspension of the tow vehicles when hooked to tow vehicles.

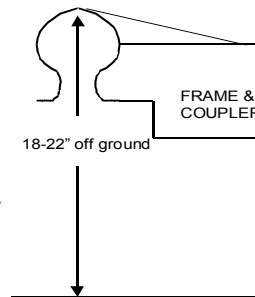

Hook-Up (Travel Trailer)

Hooking up your travel trailer is not difficult and gets easier with practice. The following procedure will help you until you become more experienced.

1. To raise the tongue of trailer above the hitch ball on hitch, turn the crank on the jack.
2. Open the coupler latch.

3. Back the tow vehicle into proper position.
4. Turn the crank on the jack to lower the coupler onto the ball hitch.
5. Close the coupler latch after completely seated, then insert a pin with a lock key or a lock.
6. Install weight distributing bars (equalizer), when required, as recommended by hitch supplier.
7. Retract the tongue jack to its maximum height.
8. Attach the cable for the breakaway switch to the tow vehicle.
9. Attach safety chains as per your state laws.
10. Plug in your 12-volt, seven way electrical connector from the tow vehicle to the trailer connector.
11. Below are listed numerous items that should be inspected and tested before traveling:
 - All lights working on outside of coach.
 - Stabilizer jacks in retracted position.
 - Steps in retracted position.
 - Refrigerator door latched completely.
 - Loose items in secure position.
 - Test brakes for operation before entering roadway.



CAUTION

Remember – always have the safety chain attached to tow vehicle, as required in your state.

The Safety Chain (Travel Trailer)

Safety chain requirements will vary from state to state. The chain supplied with your coach meets SAE requirements for maximum gross trailer weight.

1. Cross the left chain under the coupler and attach to the right mounting slot in the trailer hitch.
2. Repeat step one with the right chain. Slack for each length should be the same but not more than necessary to permit the vehicle to turn at their minimum radius.

TRAVELING

Weights

For safety reasons and federal regulations, KZRV provides accurate weight specifications to owners. On the exterior left front corner of the coach you will find the Federal "Vehicle Identification Number" sticker, as required by the federal government. This tag supplies information concerning your coach, such as: VIN number, date/month of manufacture, tire size rating, plus information about weights as described below.

Gross Axle Weight Rating (GAWR): is the value specified as the load carrying capacity of a single axle system, as measured at the tire-ground interfaces. One of five components will determine this rating, tires, axle, springs, brakes, or wheels. One of these five is generally rated slightly less than the others.

Gross Vehicle Weight Rating (GVWR): is the maximum permissible weight of this trailer when fully loaded. It includes all weight at the trailer axle(s) and tongue. This includes ALL cargo, options and liquids.

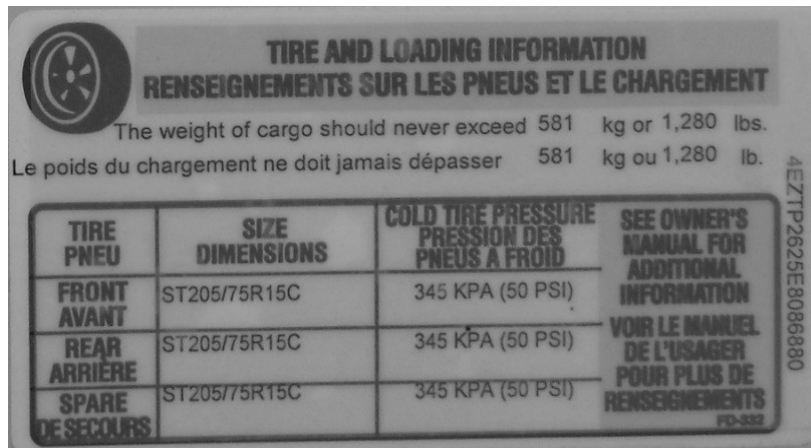

TIRE AND LOADING INFORMATION
RENSEIGNEMENTS SUR LES PNEUS ET LE CHARGEMENT

The weight of cargo should never exceed 581 kg or 1,280 lbs.
Le poids du chargement ne doit jamais dépasser 581 kg ou 1,280 lb.

TIRE PNEU	SIZE DIMENSIONS	COLD TIRE PRESSURE PRESSION DES PNEUS A FROID	SEE OWNER'S MANUAL FOR ADDITIONAL INFORMATION VOIR LE MANUEL DE L'USAGER POUR PLUS DE RENSEIGNEMENTS
FRONT AVANT	ST205/75R15C	345 KPA (50 PSI)	4E7TP2625E8086880 FD-332
REAR ARRIERE	ST205/75R15C	345 KPA (50 PSI)	
SPARE DE SECOURS	ST205/75R15C	345 KPA (50 PSI)	

Unloaded Vehicle Weight (UVW): is the weight of this trailer as manufactured at the factory. It includes all weight at the trailer axle (s) and tongue or pin. If applicable, it also includes full generator fluids, including fuel, engine oil and coolants.

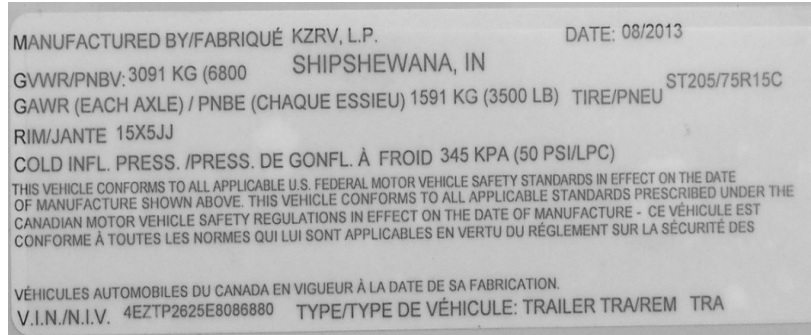

Cargo Carrying Capacity (CCC): is equal to the GVWR minus each of the following: UVW, full fresh (potable) water weight (including water heater, and full propane weight.

Weighing Vehicle (Loaded or Unloaded)

The proper method to weigh the coach is to use a truck scale. Place the coach axles (tires) and tongue jack 12" to 24" from the edge. Unhook the tow vehicle and move forward 6" to 8". Now record total weight. Re-hook the tow vehicle and remove the weight from the front support. Be sure no part of tow vehicle is on the scale. Now record the axle weight only. The difference between the two weights is the hitch weight.

KZRV suggests you also weigh each side (2 tires) separate to find balance of pounds per side. Its possible to have 1 side correct and the other side over-loaded. Often the slide out side or refer will be slightly heavier than the other.

The second sticker is about the weight of cargo placed in your coach. Location of the sticker is on the inside of your coach, on the screen door, or inside of a cabinet door. It provides listed total allowable weight of cargo minus liquids allowed, water and propane.

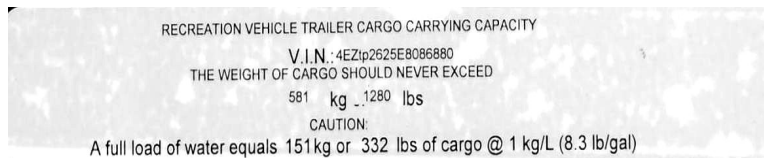

Loading the Trailer—Distribution

Your recreational vehicle has been engineered to make maximum use of the available space for living and storage areas. The equipment and supplies you take along while traveling can be carried safely, provided the additional weight is distributed properly. Proper weight distribution within your trailer is an important factor in safety and efficiency of your trailer brakes, hitching, and how your tow vehicle will pull the trailer. **DO NOT** put excess weight in the trunk only. Excessive weight in the trunk area tends to develop sway and “fishtailing” of the trailer.



CAUTION

DO NOT overload your unit. Please follow the GVWR when loading your recreational vehicle to avoid damages.

Lightweight and bulky items such as paper products, bedding, clothing, etc., should be stored in overhead cabinets and closets. Heavy items such as cooking utensils should be placed in lower cabinets. Canned goods need to be in a pantry, if so equipped, or in lower cabinets. Also, heavy items should be secured to avoid shifting during travel.

A reasonable principle in loading your coach is for every two pounds of weight loaded in front of the axle, one pound of weight must be loaded behind the axle. Also remember, improper side-to-side loading affects spring condition.

Excess weight behind the axle lightens the hitch weight and will tend to magnify any sway that may occur when passing trucks or when gusty winds are present. Uncalculated weight can and will effect road performance.

When using a weight distributing hitch and equalizer bars, you may move/transfer hitch weight from coach to tow vehicle assisting with level towing and easier travel.



WARNING

The rear bumper on the frame of your recreational vehicle is NOT designed to carry over 100 pounds of weight, therefore only the spare tire carrier and spare tire can be added to the bumper. Do not add other components to the bumper such as bike racks, generators, cargo containers, etc. could cause metal fatigue and weld stress. Any such failures could damage your property and endanger vehicles following your camper during travel, which could result in an accident. The frame is NOT designed or built to tow any trailer.

TOY HAULER—CARGO INFORMATION



CAUTION

Any damage caused by improper loading or installing additional equipment is NOT covered by KZRV Limited Warranty.

Rock Climbers and MXT's are vehicles designed to transport your "toys" to camping area of your choice.

Rock Climbers will transport up to 2— wheelers in the front cargo area, surrounded by rails. They must be anchored to the floor as you cannot depend on rails for full support. Any type of cargo placed in front open area MUST be secured before beginning your travel.

On Rock Climbers, most added weight will be in front of axles. Be sure not to over load cargo area, having potential of a frame breaking or bending.

As in any Toy Hauler, care must be taken on how you load your cargo/equipment. When you place excessive or all of your allowed (NCC) Net Cargo Capacity, weight behind the axles, it will make your coach "tongue light", causing sway, rear of tow vehicle "bouncy". Rock Climbers expect and requires weight in front cargo to prevent tongue from being too light causing potential sway concerns.

⚠ WARNING

Secure cargo and vehicles as far forward as possible. Excess weight in the rear of this trailer can result in loss of stability when towing.

Consult the trailer Owner's Manual for loading and weighing procedures. Keep the loaded tongue weight between 10% and 15% of total weight for travel trailers, and between 20% and 25% of total weight for 5th wheels.

Move cargo and/or vehicles to maintain proper balance. Do not exceed GVWR (total weight rating) or GAWRs (axle weight ratings) of the trailer or tow vehicle.

AD-115

In Toy Hauler units with rear cargo area, you may place 40% of (CCC) carrying cargo capacity in rear area, and then distribute remaining pounds. Place 2 pounds in front of axle to every 1 pound behind axle, some of this weight will be on top of axles.

Below is a blank space for you to calculate the "Cargo Carry Capacity" of your unit, based on this 40% formula. You will find the weights of your unit on a sticker, placed on the edge of the screen door. This will enable you to determine your "Cargo Carry Capacity" in the different areas of your unit.

When loading heavy cargo/contents into the rear storage area, you MUST have the stabilizer jack in down position for any vehicle movement for support.

Since Toy Haulers are designed and built to carry cargo in the rear portion of the unit, special care must be exercised in loading to prevent potential handling concerns.

Any cargo in rear area, MUST BE secured behind axles, during movement of unit. For this reason, D Rings are installed on the floor of the cargo room.

Any two wheel items such as bicycles or motorcycles, will require additional support for the front wheel, such as a "wheel chock". Any such stabilizer item such as a wheel chock, should be installed per manufacture instructions.



CAUTION

The tie downs (D-Rings) provided are for general purpose use, rating 1,500 lbs. each.

The transportation of certain types of cargo (motorcycles, bikes, etc.), will require additional accessories for secure transport. Please refer to owners manuals of these accessories or contact the manufactures of these specific items for more information.

Interior, Cargo Area

- * Cargo Area. When sleeping or occupying this area, care must be taken. There are two vents, one located on each side. These vents must be open if the presence of gasoline filled equipment is in the cargo area.
- * Sleeping commendations. Available option is a power lift bed. This bed assembly is attached to the sidewall at all four corners of the bed. Bed assembly can be raised or lowered as needed through a 12 volt D.C. motor source. Switch is located on the sidewall. The power bed assembly can be raised to the ceiling allowing storage,

Rear Screen Door (Optional)

A full pull down screen door is available to prevent insects from entering and can be installed at a later time. It operates much like a garage door, manually up or down as you choose. With screen door you may leave large outer door open and have fresh air while avoiding vermin's and insects.

Rear Cargo Door

Rear door on Toy Hauler is "spring loaded", also known as having preset and designed springs attached along with hinge assembly at the bottom of the door. As you lift up or down these springs support most of the weight. Size and quantity of springs determine amount of weight they support. Springs are NOT adjustable. Door also

serves as ramp. A latch on each side ensures tightness when closed. Handle will latch into lock when closed. Lock may be secured with key.

! DANGER

ANY MOTORIZED VEHICLE OR ANY MOTORIZED EQUIPMENT POWERED WITH FLAMMABLE LIQUID CAN CAUSE FIRE, EXPLOSION, OR ASPHYXIATION IF STORED OR TRANSPORTED WITHIN THE RECREATIONAL VEHICLE. TO REDUCE THE RISK OF FIRE, EXPLOSION, OR ASPHYXIATION:

- 1. Do not ride in the vehicle storage area while vehicles are present.**
- 2. Do not sleep in the vehicle storage area while vehicles are present.**
- 3. Close doors and windows in walls of separation (if installed) while any vehicle is present.**
- 4. Run fuel out of engines of stored vehicles after shutting off fuel at the tank.**
- 5. Do not store, transport, or dispense fuel inside this vehicle.**
- 6. Open the windows, openings, or air ventilation systems provided for venting the transportation area when vehicles are present.**
- 7. Do not operate propane appliances, pilot lights, or electrical equipment when motorized vehicles are present.**

!!! DANGER !!!

FAILURE TO COMPLY COULD RESULT IN AN INCREASED RISK OF FIRE, EXPLOSION, ASPHYXIATION, DEATH, OR SERIOUS INJURY.

AD-06

Fuel Cell (Option)

The fuel cell system was developed for each owner to carry gasoline in a tank installed under the frame between two special cross members welded to the frame. The tank is attached with three cross bars bolted to the frame members with grade # 5 bolts and nuts. Fuel in the single tank will supply gasoline for generator plus any toys having a gasoline motor. When dual tanks are installed, front tank feeds only the generator and rear tank supplies fuel to be dispersed to a motorized vehicle. Each tank will have its own gauge giving available fuel in tank. Rear tank will have a pump, hose, and discharge nozzle.

For prevention of static electricity, a ground wire has been prepared for owner to connect to vehicle being filled with gasoline. Use alligator clip to connect to vehicle.

Power for the pump is supplied by a 12 volt battery, or convertor when 120 AC power is available. It is fused through the 12 volt panel in the load center. Don't forget to connect ground jumper wire.

All required hoses, along with vents are installed. Place nozzle into tank and squeeze handle to release fuel into desired container.

WARNING: The nozzle DOES NOT have a “automatic shut-off” on it.

⚠ DANGER
NO SMOKING
BEFORE DISPENSING FUEL, TURN OFF ALL ENGINES, FUEL BURNING APPLIANCES AND THEIR IGNITORS. CONNECT THE BONDING JUMPER WIRE TO THE VEHICLE RECEIVING FUEL. DO NOT DISPENSE FUEL WITHIN 20 FEET OF AN IGNITION SOURCE. FAILURE TO COMPLY COULD RESULT IN FIRE, DEATH, OR SERIOUS INJURY.

CAUTION
GASOLINE ONLY
MAKE SURE ALL PILOT LIGHTS ARE OFF BEFORE FILLING GAS TANK

Towing

In towing your trailer you need to recognize the extra weight behind your vehicle. Below is a list of things which you need to remember while traveling.

1. With the trailer attached you will have slower acceleration and will require more distance to stop.
2. Be sure you have enough area at corners when turning, as wider turns are necessary. Be sure to use your turn signals for your own safety and the safety of others.

3. In passing or changing lanes remember you will need a longer distance to pass.
4. Use your rearview mirrors frequently to observe your trailer and traffic conditions.
5. When being passed by a large truck or bus, be prepared for displaced air as it may cause you to sway slightly, especially travel trailers.
6. When climbing steep, long grades and again while descending, use lower gears even before it seems necessary. Use your brakes smoothly and evenly.
7. Remember to drive more slowly on wet and icy highways to keep control of your vehicle.

Tires

All KZRV towable coaches are equipped with appropriate tires for recreational vehicles. Tires are rated to carry weight as listed to G.V.W.R. Tires are radial in design using components to offer excellent strength and mileage in all kinds of weather conditions.

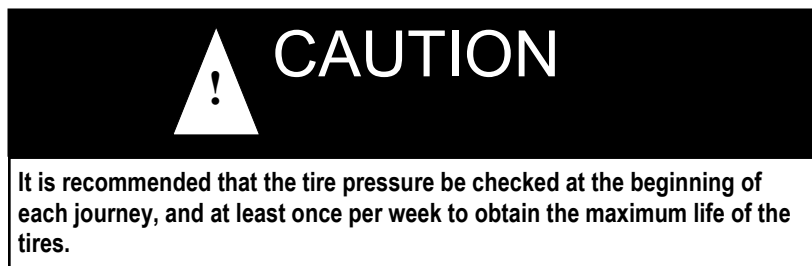

Tires on your vehicle(s) are one of the most important components of the towing package. Without inflated tires you will not be moving anywhere.

Studies of tire safety show that maintaining proper tire pressure, observing tire and vehicle load limits (not carrying more weight in your vehicle than your tires or vehicle can safely handle), avoiding road hazards, and inspecting tires for cuts, slashes, and other irregularities are the most important things you can do to avoid tire failure, such as tread separation or blowout and flat tires. These actions, along with other care and maintenance activities, can also:

- Improve vehicle handling.
- Help protect you and others from avoidable breakdowns and accidents.

- Improve fuel economy.
- Increase the life of your tires.

This booklet presents a comprehensive overview of tire safety, including information on the following topics:

- Basic tire maintenance.
- Uniform Tire Quality Grading System.
- Fundamental characteristics of tires.
- Tire safety tips.

Use this information to make tire safety a regular part of your vehicle maintenance routine. Recognize that the time you spend is minimal compared with the inconvenience and safety consequences of a flat tire or other tire failure.

Safety First-Basic Tire Maintenance

Properly maintained tires improve the steering, stopping, traction, and load carrying capability of your vehicle. **Under inflated tires and overloaded vehicles are a major cause of tire failure.** Therefore, as mentioned above, to avoid flat tires and other types of tire failure, you should maintain proper tire pressure, observe tire and vehicle load limits, avoid road hazards, and regularly inspect your tires.

Finding Your Vehicle's Recommended Tire Pressure and Load Limits

Tire information placards and vehicle certification labels contain information on tires and load limits. These labels indicate the vehicle manufacturer's information including:

- Recommended tire size.
- Recommended tire inflation pressure.
- Vehicle capacity weight (VCW-the maximum occupant and cargo weight a vehicle is designed to carry).
- Front and rear axle weight ratings (GAWR-the maximum weight the axle systems are designed to carry).

[For TT] Both placards and certification labels are permanently attached to the trailer on the forward half of the left side, and are easily readable from outside the vehicle without moving any part of the vehicle. You can find the recommended tire pressure and load limit for your vehicle in the vehicle owner's manual.

Understanding Tire Pressure and Load Limits

Tire inflation pressure is the level of air in the tire that provides it with load-carrying capacity and affects the overall performance of the vehicle. The tire inflation pressure is a number that indicates the amount of air pressure—measured in pounds per square inch (psi) - a tire requires to be properly inflated. (You will also find this number on the vehicle information placard expressed in kilopascals (kPa), which is the metric measure used internationally.)

Vehicle manufacturers determine this number based on the vehicle's design load limit, that is, the greatest amount of weight a vehicle can safely carry and the vehicle's tire size. The proper tire pressure for your vehicle is referred to as the "recommended cold inflation pressure." (As you will read below, it is difficult to obtain the recommended tire pressure if your tires are not cold.)

Because tires are designed to be used on more than one type of vehicle, tire manufacturers list the "maximum permissible inflation pressure" on the tire sidewall. This number is the greatest amount of air pressure that should ever be put in the tire under normal driving conditions.

Checking Tire Pressure

It is important to check your vehicle's tire pressure at least once a month for the following reasons:

- Most tires may naturally lose air over time.
- Tires can lose air suddenly if you drive over a pothole or other object or if you strike the curb when parking.
- With radial tires, it is usually not possible to determine under inflation by visual inspection.

For convenience, purchase a tire pressure gauge to keep in your vehicle. Gauges can be purchased at tire dealerships, auto supply stores, and other retail outlets.

The recommended tire inflation pressure that vehicle manufacturers provide reflects the proper psi when a tire is cold. The term cold does not relate to the outside temperature. Rather, a cold tire is one that has not been driven on for at least three hours. When you drive, your tires get warmer, causing the air pressure within them to increase. Therefore, to get an accurate tire pressure reading, you must measure tire pressure when tires are cold or compensate for the extra pressure in warm tires.

Steps for Maintaining Proper Tire Pressure

- Step 1: Locate the recommended tire pressure on the vehicle's tire information placard, certification label, or in the owner's manual.
- Step 2: Record the tire pressure of all tires.
- Step 3: If the tire pressure is too high in any of the tires, slowly release air by gently pressing on the tire valve stem with the edge of your tire gauge until you get to the correct pressure.
- Step 4: If the tire pressure is too low, note the difference between the measured tire pressure and the correct tire pressure. These "missing" pounds of pressure are what you will need to add.
- Step 5: At a service station, add the missing pounds of air pressure to each tire that is under inflated.
- Step 6: Check all the tires to make sure they have the same air pressure (except in cases in which the front and rear tires are supposed to have different amounts of pressure).

If you have been driving your vehicle and think that a tire is under inflated, fill it to the recommended cold inflation pressure indicated on your vehicle's tire information placard or certification label. While your tire may still be slightly under inflated due to the extra pounds of pressure in the warm tire, it is safer to drive with air pressure that is slightly lower than the vehicle manufacturer's recommended cold inflation pressure than to drive with a significantly under inflated tire. Since this is a temporary fix, don't forget to recheck and adjust the tire's pressure when you can obtain a cold reading.

Tire Size

To maintain tire safety, purchase new tires that are the same size as the vehicle's original tires or another size recommended by the manufacturer. Look at the tire information placards, or the sidewall of the tire you are replacing to find this information. If you have any doubt about the correct size to choose, consult with the tire dealer.

Tire Tread

The tire tread provides the gripping action and traction that prevent your vehicle from slipping or sliding, especially when the road is wet or icy. In general, tires are not safe and should be replaced when the tread is worn down to 1/16 of an inch. Tires have built-in tread

wear indicators that let you know when it is time to replace your tires. These indicators are raised sections spaced intermittently in the bottom of the tread grooves. When they appear “even” with the outside of the tread, it is time to replace your tires. Another method for checking tread depth is to place a penny in the tread with Lincoln’s head upside down and facing you. If you can see the top of Lincoln’s head, you are ready for new tires.

Tire Balance and Wheel Alignment

Tires are not balanced on your unit, nor is it required. You may choose to balance the tires on your unit, however this will not be covered under warranty.

Wheel alignments may be needed periodically due to road hazards, such as pot holes, etc. This also is not covered under warranty, due to being a uncontrollable element. Wheel alignments, will assist with getting the maximum life from your tires. Alignments require special equipment, and should be performed by a technician.

Tire Repair

The proper repair of a punctured tire requires a plug for the hole and a patch for the area inside the tire that surrounds the puncture hole. Punctures through the tread can be repaired if they are not too large, but punctures to the sidewall should not be repaired. Tires must be removed from the rim to be properly inspected before being plugged and patched.

Tire Fundamentals

Federal law requires tire manufacturers to place standardized information on the sidewall of all tires. This information identifies and describes the fundamental characteristics of the tire and also provides a tire identification number for safety standard certification and in case of a recall.

* **U.S. DOT Tire Identification Number** –This begins with the letters “DOT” and indicates that the tire meets all federal Standards. The next two numbers or letters are the plant code where it was manufactured, and the last four numbers represent the week and year the tire was built. For example, the numbers3197 means the 31st week of 1997. The other numbers are marketing codes used at the manufacture’s discretion. This information is used to contact consumers if a tire requires a recall.

- * **Tire Ply Composition and Material Used**– The number of plies indicates the number of layers of rubber-coated fabric in the tire. In general, the greater the number of plies, the more weight a tire can support. Tire manufactures also must indicate the materials in the tire, which include steel, nylon, polyester and others.
- * **Maximum Load Loading**-This number indicates the maximum load in kilograms and pounds that can be carried by the tire.
- * **Maximum Permissible Inflation Pressure**-This number is the greatest amount of air pressure that should ever be put in the tire under normal driving conditions.

Additional Information on Light Truck Tires

Please refer to the following diagram.

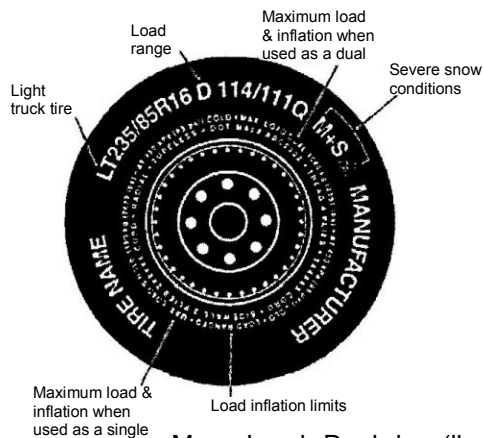

Tires for light trucks have other markings besides those found on the sidewalls of passenger tires.

LT—The “LT” indicates the tire is for light trucks or trailers.
 ST—An “ST” is an indication the tire is for trailer use only

Max. Load Dual kg (lbs) at kPa (psi) Cold—This information indicates the maximum load and tire pressure when the tire is used as a dual; that is, when four tires are put on each rear axle (a total of six or more tires on the vehicle).

Load Range—This information identifies the tire’s load-carrying capabilities and its inflation limits.

Vehicle Load Limits

Determining the load limits of a vehicle includes more than understanding the load limits of the tires alone.

[For TT] On a trailer, there is a Federal Certification label that is located on the forward half of the left (road) side of the unit.

The certification label will include the vehicle's gross vehicle weight rating (GVWR). This is the most weight the fully loaded vehicle can weigh. It will also provide the gross axle weight rating (GAWR). This is the most weight a particular axle can carry. If there are multiple axles, the GAWR of each axle will be provided.

[For TT] In the same location as the certification label described above, there is a vehicle placard. This placard provides tire and loading information. In addition, this placard will show a statement regarding maximum cargo capacity.

Cargo Capacities

[For TT] Cargo can be added to the vehicle, up to the maximum weight specified on the placard. The combined weight of the cargo is provided as a single number. In any case, the total weight of a fully loaded vehicle can not exceed the stated GVWR.

Water and propane also need to be considered. The weight of fully filled propane containers is considered part of the weight of the RV before it is loaded with cargo and is not considered part of the disposable cargo load. Water however, is a cargo weight and is treated as such. If there is a fresh water storage tank of 100 gallons, this tank when filled would weigh about 800 pounds. If more cargo is being transported, water can be off-loaded to keep the total amount of cargo added to the vehicle within the limits of the GVWR so as not to overload the vehicle. Understanding this flexibility will allow you, the owner, to make choices that fit your travel and camping needs.

When loading your cargo, be sure it is distributed evenly to prevent overloading front to back and side to side. Heavy items should be

placed low and as close to the axle positions as reasonable. Too many items on one side may overload a tire. The best way to know the actual weight of the vehicle is to weigh it at a public scale. Talk to your RV dealer to discuss the weighing methods needed to capture the various weights related to the RV. This would include weights for the following: axles, wheels, hitch, and total weight.

How Overloading Affects Your RV and Tires.

The results of overloading can have serious consequences for passenger safety. Too much weight on your vehicle's suspension system can cause spring, shock absorber, or brake failure, handling or steering problems, irregular tire wear, tire failure or other damage.

An overloaded vehicle is hard to drive and hard to stop. In cases of serious overloading, brakes can fail completely, particularly on steep hills. The load a tire will carry safely is a combination of the size of tire, its load range, and corresponding inflation pressure.

Excessive loads and/or under inflation cause tire overloading and, as a result, abnormal tire flexing occurs. This situation can generate an excessive amount of heat within the tire. Excessive heat may lead to tire failure.

It is the air pressure that enables a tire to support the load, so proper Inflation is critical. Since RVs can be configured and loaded in many ways, air pressures must be determined from actual loads (determined by weighing) and taken from the load and inflation tables provided by the tire manufacturer. These air pressures may differ from those found on the certification label. However, they should never exceed the tire limitation for load or air pressure. If you discover that your tires cannot support the actual weights, the load will need to be lighten.

Tire Safety Tips

Preventing Tire Damage

- Slow down if you have to go over a pothole or other object in the road.
- Do not run over curbs or other foreign objects in the roadway, and try not to strike the curb when parking.

Tire Safety Checklist

- Check tire pressure regularly (at least once a month), including the spare.
- Inspect tires for uneven wear patterns on the tread, cracks, foreign objects, or other signs of wear or trauma.
- Remove bits of glass and foreign objects wedged in the tread.
- Make sure your tire valves have valve caps.
- Check tire pressure before going on a long trip.
- Do not overload your vehicle. Check the Tire Information and Loading Placard or User's Manual for the maximum recommended load for vehicle.

Note: Tires are warranted by the manufacturer of their respective brand and are to be serviced and warranted by a service center. Contact your dealer for information on service centers for tires.

How to Change a Tire

To change a tire on your coach, place a jack under the main rail of frame. You may wish to break the lug nuts loose before raising coach. Be sure to block trailer to prevent coach or jack movement. Do not remove nuts from lug bolts until tire is free from ground.

Wheel Lugs

When the wheels are installed on your recreational vehicle, the lug nuts must be tightened at 90-120 foot pounds of torque. Powder coat painted wheels may require more torquing attempts due to thickness of paint. You must re-torque the wheel lugs at 50 and 200 miles. A decal on the wheel may require torquing earlier.

After your first trip, check the wheel lugs periodically for safety. The wheel lugs should then be checked after winter storage, before starting a trip or following extensive braking. The size of bolts or nuts is 13/16 inch standard and 3/4 inch for chrome nut. **Over torquing will damage components especially if torque wheel lugs goes over 150 pounds. Normally the "nut" fails first however the embossing on the wheel can also be flattened, and then fail to keep the wheel tight.**

Brakes—Electrical

Electric brakes on your recreational vehicle are designed to work in conjunction with the hydraulic brakes on your tow vehicle. This

means to have the best brake performance on both systems, the trailer and the tow vehicle must perform and operate together. Any attempt to use either brake system alone, tow vehicle or trailer will cause accelerated wear and damage.

A brake control must be installed in your tow vehicle to activate electric brakes with 12-volt power either manually or by foot brake pedal.

Two types of controllers are available. First is the "hydraulic" which operates through a steel line attached to the master cylinder of tow vehicle's brake system. The second type is an "electronic" controller, operating completely on electric current. See the operating instructions provided with the controller for adjustment and operation procedures.

Your controller is to be installed below the dash board of your tow vehicle. Use the foot pedal control for general operation on combined use of both brake systems. Manual control is to be used only in special situations, such as slow movement or icy road conditions. In open position, electrical current will flow to brake assemblies activating them.

Power from the battery is sent to the controller, the "switch" to provide the correct amount of current to brake assemblies on the coach. As you press harder on the brake pedal, more current will flow, applying brakes more, increasing braking capability.

Your battery in the tow vehicle is your primary power source to operate the brakes in your towable trailer. Keep your battery and charging system in working condition to ensure available energy when required.

Wiring to operate your brakes must be sized in both vehicles, suggesting a minimum of 14 gauge. Your camper has 14 gauge from front end to brakes. Brake assemblies are wired in parallel, never in a series. Being parallel, there will be equal voltage and amperage at each brake assembly for equal braking capability and/or performance.

When applying brakes to stop the trailer, begin pressing slowly to avoid quick and sudden stops, or possible "jack-knife" when wet or slippery. Use lower gear ranges to minimize the need of brakes during extended or steep downgrades

The brake system on your unit is self-adjusting. Brake self-adjusts every forward stop ensuring consistent braking.

Breakaway Switch

The breakaway switch is a safety part of your trailer's electric brake system. The very instant a breakaway occurs, the pull pin which is linked to the tow vehicle is pulled from the switch. The two contacts automatically close to complete the electrical circuit and apply the trailer brakes. This system will apply the brakes of the trailer should it become loose or detached from the tow vehicle. A 12-volt battery installed on the coach is required to power the breakaway switch.

NEVER use this breakaway switch and trailer brake system as a parking brake. There would be a high amp draw on battery and convertor, potentially causing damaged wiring, connectors, and breakaway switch plus unnecessary energy draw.

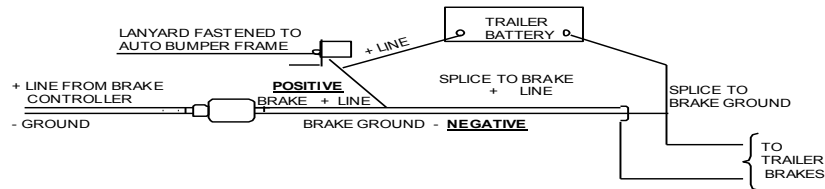

**SAFETY BREAK-AWAY SWITCH
WILL NOT OPERATE**
Unless connected to a power source
equivalent to or greater than an auto-
motive type 12 volt, 12 amp hour
wet-cell battery.

Fire Extinguisher

A fire extinguisher is installed in each vehicle and is located near the entrance door in the recreational vehicle. Be familiar with its location and operating instructions as printed on the extinguisher. Inspect your fire extinguisher at least two times per year or more often, as instructed on the extinguisher.

SETTING UP AND USING YOUR RECREATIONAL VEHICLE

We recommend that you select a level or nearly level place for camping. There are two reasons to be level. First, all components in your coach, such as your water drainage system and especially your refrigerator, are designed to operate in a level position. Second, it is more comfortable to live on the level. Should a level site not be available, use short 2 x 6 inch blocks of wood to raise the low side wheels to a level position.

Before unhooking the trailer from the tow vehicle, be sure the jack foot is in place on the tongue jack and block the trailer wheels to keep the trailer from moving.

Before lowering the tongue jack, you may wish to place a wood block or hard support under the foot of the jack, unless you are on a cement slab. This helps to prevent the jack from sinking into the dirt.

Travel Trailer Hook Up

1. Release the weight distributing bars (if used).
2. Unlock or remove safety pin from coupler latch, then release the safety latch on the coupler.
3. Raise the coupler on the A-frame by turning the tongue jack until the ball is free.
4. Disconnect the 7-way wire connector, safety chains, and the breakaway cable.
5. Raise front jack until Tow vehicle will clear coach. Drive Tow vehicle away.
6. Now raise/lower front end until coach is level.
7. Lower stabilizer jacks to desired position to stabilize coach.
8. Reverse procedure to hook up coach to tow vehicle.

The use of stabilizer jacks on a recreational vehicle is a popular and useful option. They provide a reasonable amount of stability while using, occupying, and moving around in your camper. It is important to remember that stabilizer jacks are for support of the coach and are not designed to bear the weight of a recreational vehicle.

To operate the stabilizer jack, place crank onto the jack shaft and turn clockwise to lower until the frame begins to raise slightly. Equalize all four jacks for best support. You may need to adjust each jack two or three times.

To raise jack to upper travel position, insert crank and turn counterclockwise until jack is seated in UP travel position.

Upon completing the setup of your coach, you are now ready to make attachments to various facilities:

- ❖ Waste water hose connections.
- ❖ 110-Volt power cord electrical hookup.
- ❖ Turn on propane tanks and light pilot lights, if any, on appliances. Remember there may be air in your propane lines. Be sure to bleed them before planned usage.
- ❖ Open any windows and roof vents as desired for ventilation.
- ❖ Fresh water connections.

You may have additional accessories and options, such as an awning on the door side which need to be opened. Separate instructions are provided by the manufacturer of these components.

 CAUTION
When preparing to depart or move, don't forget to reverse the procedure above. Remember, open roof vents, windows, or TV antennas left in UP position are subject to wind damage in transit.

SAFETY DETECTORS

Propane/ Carbon Monoxide Detector

Any recreational vehicle which contains a propane fuel system with propane consuming appliances requires a propane leak detection device for safety protection. Currently this detector also serves as a carbon monoxide as a combination protection device. A converter or auxiliary battery is required to supply 12-volt DC energy to operate the detector. There is no master cut-off switch to disengage detector.

What Is Carbon Monoxide?

Carbon Monoxide (CO) is a highly poisonous gas which is released when fuels are burnt. It is invisible, has no smell and is therefore very difficult to detect with the human senses. Under normal conditions, in a room where fuel burning appliances are well maintained and correctly ventilated, the amount of carbon monoxide released into the room by appliances is not dangerous. These fuels include: wood, coal, charcoal, oil, natural gas, gasoline, kerosene, and propane. Such gases can built up in the blood, interfering with the body's ability to supply oxygen to itself.

Because CO is a colorless, odorless, tasteless, and highly poisonous gas that prevents the blood from carrying oxygen to vital organs, CO is 200 times more likely to replace oxygen in the blood. It can endanger lives even at low levels of concentration.

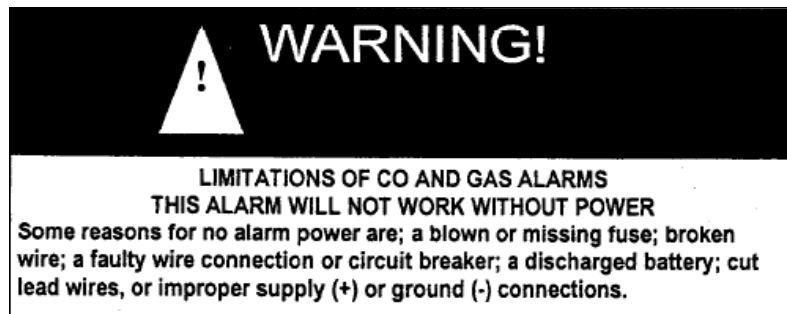

Dual Sensor Technology

The SAFE-T-ALERT 70 series combination CO/Propane Gas Alarm is an alarm that combines into a single, compact system a powerful alarm that detects both carbon Monoxide (CO) and explosive gases

propane (LPG) and Methane (Natural Gas).

The 70 series uses the latest microprocessor technology combined with two electronic self-cleaning sensors that operate independently of each other. The combined unit can detect CO and explosive gases simultaneously.

Operation

When the unit is first powered up, the CO sensor requires a ten (10) minute initial warm-up period to clean the sensor element and achieve stabilization. The GREEN LED indicator will flash on and off during the 10 minute warm-up period. The unit cannot go into a CO alarm during the warm-up period. To test your unit during the warm-up period, press the test button. See Test Procedure in this manual. After the warm-up period, the GREEN power ON indicator should glow continuously if the ON indicator light does not light, see the section, **Trouble-Shooting Guide**, in this manual for further information. **Do not attempt to fix it yourself.**

Gas Alarm: When you power the alarm, it has a warm-up period of approximately 1 minute. This unit cannot go into a gas alarm during the warm-up period. After 1 minute the alarm can detect explosive gas and will energize the relay on models 70-742-R and 70-742-R-MS.

Simultaneous CO and Gas Alarms— Because the risk of a propane gas explosion is generally a more serious danger, you alarm unit gives the gas alarm a higher priority during simultaneous alarm condition.

If your unit generates alarms for both Gas and CO at the same time, the gas LED will flash red and the beeper will sound. The CO LED will be a solid Red until the CO is ventilated out of the RV, at which time the LED will return to the Green operational/safe color.

Brownout Protection— The unit can tolerate short power interruptions and brownouts where the circuit voltage drops as low as 1 VDC. If the brownout lasts too long, the unit will reset and operate as described above.

Low Power Operation

This alarm will operate normally down to 7 VDC. Do not operate this alarm below 7 VDC.

Visual and Audible Alarm Signals

This SAFE-T-ALERT™ CO/Propane Gas Alarm is designed to be easy-to-operate. The alarm has two indicator lights that display a specific color for each monitored condition. There also is a matching sound pattern for alarm conditions.

CO Alarm

The Red CO LED will flash and the alarm will sound 4 “BEEPS” then be silent for 5 seconds. These signals indicates that the CO level is over 70 ppm. **IMMEDIATE ACTION IS REQUIRED.** See the **Procedures To Take During An Alarm** in the user’s manual that is supplied with the detector. This cycle will continue until the TEST/Mute button on the front of alarm is pressed. Ventilate the RV. The RED light will stay ON until the CO has cleared, or the alarm will reactivate in approximately 6 minutes if the CO is still present. DO NOT RE-ENTER THE RV. This alarm will return to normal operation after the RV’s properly ventilated.

Propane Gas Alarm

The RED LED will flash and the alarm will sound a steady tone whenever a dangerous level of propane or methane gas is detected. **IMMEDIATE ACTION IS REQUIRED.** See **Procedures To Take During A Gas Alarm.** The detector will continue to alarm until the Test/Mute switch on the front of the alarm is pressed. Ventilate the RV. The RED Gas LED will continue to flash until the gas has cleared, or the gas alarm will reactivate in approximately 5 minutes if the gas is still present. DO NOT RE-ENTER THE RV. This alarm will return to normal operation after the RV is properly ventilated.

MALFUNCTION/SERVICE SIGNAL. If any malfunction is detected, the Gas LED will remain off and the Operational/CO LED will alternate Red/Green and the alarm will sound once every 15 seconds. Press the Test/Mute button. If the Test/Mute button does not clear signals, check the battery voltage. **If the battery voltage is not low and the unit will not return to normal operation, immediately remove the alarm and return for service or warranty replacement.**

<u>OPERATION</u>	<u>AUDIBLE SIGNAL</u>	<u>VISUAL SIGNAL</u>
NORMAL	NONE	STEADY GREEN
CO ALARM	4"BEEPS" 5 SECONDS OFF	STEADY RED
PROPANE ALARM	CONSTANT	FLASHING RED
ALARM MALFUNCTION	"BEEP" EVERY 30 SECONDS	ALTERNATING RED/GREEN

Smoke Alarm

Smoke alarms are placed on the ceiling between the sleeping area and cooking area of each RV built.

Operation: The smoke alarm is in operation once the battery is correctly connected. The LED will flash every minute to show the battery is supplying power to the alarm. When production of combustion are sensed, the unit sounds a loud alarm which continues until the air is cleared.

False Alarm "Mute" Controls: Models (S/SLL) with the mute feature have the capability of temporarily reducing the sensitivity of the alarm circuit for approximately 10 minutes. This feature is to be used only when a known alarm condition such as smoke from cooking activates the smoke alarm. The smoke alarm is muted by pushing and holding the test button on the alarm cover for 5 seconds. The smoke alarm will automatically reduce sensitively and the LED will "flash" every 10-20 seconds for approximately 10 minutes to indicate the alarm is in temporary mute condition. The smoke alarm is completely operational during the mute cycle and will alarm if the smoke density increases. After the 10 minutes mute cycle the alarm will "beep" twice letting you know it has automatically returned to normal sensitivity.

CAUTION: Before using the "mute" feature, identify the source of smoke and be certain that safe conditions exist.

Testing: Test the smoke alarm by pushing the test button on the smoke alarm cover for at least three seconds, until the alarm sounds. The alarm sounds if all electronic circuitry, horn and battery are working. If no alarm sounds, the unit has a defective battery or other failure and should be replaced immediately.

- Test each smoke alarm weekly to be sure it is installed correctly and operation properly.
- Test smoke alarms after the recreational vehicle has been in storage, before each trip, and at least once per week during use.
- Stand at arm's length from the smoke alarm when testing. The alarm horn is loud to alert you to an emergency. The alarm horn may be harmful to your hearing.
- The test button accurately tests all functions. Never use an open flame from a match or lighter to test this smoke alarm. You may ignite and set fire to the smoke alarm and your home.



WARNING

Test smoke alarm operation after vehicle has been in storage, before each trip, and at least once per week during use. Failure to comply may result in serious injury.

General Detector Information

As you are confined in a RV which is much smaller than a standard house, you must realize safety detectors will be activated much sooner than a residential house, due to there being much less air volume.

Each listed detector has its own manual and instructions sheet, providing more information for its use and maintenance. Life time of the detector is 5 years, and needs to be replaced as per manufacturers instructions, in the user's guide.

Steps (Two or Three)

Before entering your recreational vehicle place your hand in the center of the step assembly. Pull the step outwards. The step assembly will raise slightly and then out, away from the coach. The lower step will unfold 180° to useable position. The arm on the step will meet a positive stop. Step care, maintenance and lubrication will be found in the maintenance manual.



CAUTION

After lubrication, be sure no lubricant is remaining on step, causing a person to slip.

Windows

All windows are of slider opening design, solid picture window, or opening vent panels. Sliders may open horizontal or vertical as called for per floor plan. Egress (Escape) windows have an unlocking handle or two small hinged clips on each side. After unlatching, the panel will swing out on a top hinge. On some Egress (Escape) windows, screens are attached to swing out panel of window.

Doors

Locks on entrance doors have two lock mechanisms, a deadbolt in the frame section of lock and a standard lock in the handle. Both locks use the same key.

Screen doors usually have a hook/lever type of latch. Pull lever downward to release door.

Locks on trunk doors need a small quantity of silicone lubricant sprayed internally two times per year to keep functioning correctly.

TV Antennas (Standard Roof Mount) Winegard Sensor

To raise antenna to operating position. Turn elevating crank (clockwise) in "UP" direction about 13 turns or until some resistance to turning is noted.



For amplified models only. Turn power supply ON to use either front or rear TV outlet. Neither outlet will work unless power supply switch is ON.

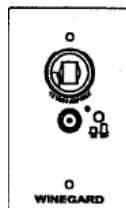

DO NOT connect high current devices such as hair dryers to this receptacle. Maximum current rating of this receptacle is 8 amps at +12 VDC.



To rotate antenna for best picture. Make sure antenna is in "UP" position. Pull down with both hands to disengage ceiling plate. Rotate for best picture.

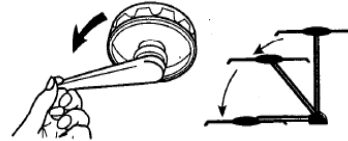

To lower antenna to travel position. Rotate antenna until pointer on directional handle aligns with pointer on ceiling plate. Turn elevating crank (counter clockwise) in "DOWN" direction about 13 turns or until resistance is noted. Antenna is now locked in travel position.



IMPORTANT: Under no conditions should the antenna be raised while traveling.

	CAUTION
<p>When lowering the antenna, never, lower it into any position except the TRAVEL POSITION. Failure to lower antenna into the TRAVEL POSITION before traveling will very possibly cause damage, not covered by warranty.</p>	
	CAUTION
<p>The power supply should be turned OFF when connecting/disconnecting cables to power supply and antenna, but should be turned ON when testing for voltage.</p>	

To Test System

1. Make sure TV set is working properly.
2. Switch power supply ON and OFF watching for difference in picture quality. If there is no difference, see manual provided with antenna for steps to follow.

For complete operation instructions, see manual provided with antenna.

Slide-Outs

With many models of trailers, KZRV builds numerous slide out systems as listed on following page, followed by descriptions. Several different vendors supply components, loose and/or attached

to the frames.

1. Below frame system—All metal components are external, located under floor and in frame, inside of enclosed underbelly cover.
2. Above floor system—All components are inside and above floor, to be found under dinette or sofa slide out.
3. Cable system—Used on all rear slide outs. All but 4 short sections of system are enclosed inside of rear wall assembly, 2 at the top, and 2 at the bottom of slide.

Before operating the power slide-out system in your coach, read and become familiar with these instructions, along with components and operation methods. Most of these components are inside of the enclosed underbelly cover and can't be seen.

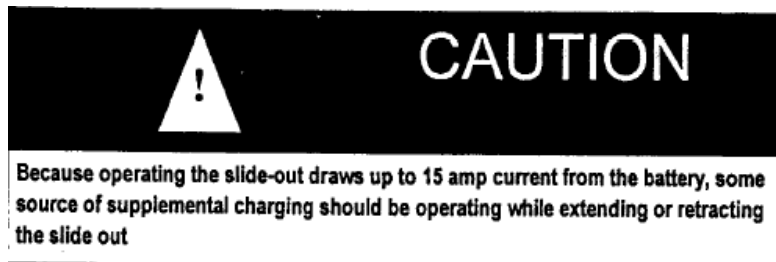

Power For Operation

All power slide systems operate on 12 volt DC power provided by a fully charged auxiliary battery and converter. Thru a 12 volt distribution load center breakers are provided for each slide. For best performance, have 120 volt AC power attached to your coach, feeding the distribution load center. Tow vehicle 12V power may also be used as required.

A automatic reset breaker is located in the distribution box feeding the operation switch to the motor.

Supplement your battery by either one of two choices

1. Hook up a 120 volt AC power cord to recreational vehicle for convertor option.
2. Use 12 volt power through the tow vehicle to the recreational vehicle battery or batteries.

Either of these methods will help ensure maximum electrical power for the slide-out motor, as well as maintain your battery.

 **CAUTION**

When opening slide room, DO NOT over-extend. Fascia board can be distorted, loosened or bent from correct position

 **WARNING**

Stand clear of the room's interior path and verify that the room's exterior path is clear before extending or retracting the room.

 **WARNING**

- ◆ Always make sure that the trailer is level before operating the slide-out room.
- ◆ Always make sure there are no obstructions blocking the path of the room when it is moving.
- ◆ Always make sure that the room path is clear of people and objects before operating.
- ◆ Always keep away from the slide rails under the coach when the room is in motion.

FAILURE TO FOLLOW THESE INSTRUCTIONS COULD RESULT IN SERIOUS INJURY OR DEATH.

Trailer Set Up Requirements—General

Note:

1. Before operating the slide-out room, level the trailer front to rear and side to side.
2. Extend all stabilizer jacks to make solid contact with the ground and/or on solid blocks. Placing stabilizer jacks onto a hard surface allows the coach to remain square and assure a good weather tight seal between the room and trailer sidewall.

Below Floor Slide System

Mechanical Components

Under floor slide-out mechanism steel bars are welded to the frame members. A gear track is welded to bottom side of cross member, matching with a flat gear attached to drive shaft, "LCS (Lippert Component System). With the "DVS" (Dexter Venture System) uses a gear with round holes stamped into a cross member. Operation on both is identical. As motor turns, a ram moves the gear on the track. A cross shaft, from front to rear ram, connects the second ram moving the opposite end of slide. Mechanism operates the same, flush or standard floor.

Above Floor Slide-Out

This system also operates on an inside ram assembly on a track moved by a gear. Ram is attached to the floor and side wall with a moving track attached to the slide-out. On larger slides, two rams will be used with cross shaft connecting the two rams. A steel frame carriage style is used on some models, doing same function generally as a 12' slide. Access to these components is inside of coach, under slide floor.

Open: Hold operation switch until room seals tightly on the exterior of the unit. DO NOT distort or bend the exterior flanges or interior fascia by holding the switch in the "ON" position.

Close: To retract, reverse the procedure and hold button until the room is fully inside with gaskets sealing to the outer wall. It takes about 20 seconds to move slide in or out.

KZRV does not require or suggest blocking, supports, jacks, etc. to be used under slide-outs during extended normal use.

Electrical Components

A 12 volt DC motor is located under the frame. It may be inside of main rail on frame, or on some models it will be on the outer side of main rail along with a front to rear shaft. On the above floor shaft, it will be under the floor of the sofa or dinette.

Operational Switch: This switch is a three

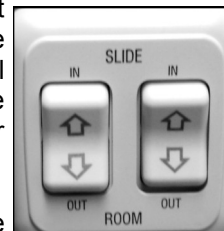

position, (off center, in or out) spring loaded switch. Select which direction you wish to move the room. Press on desired position and hold until room is seated, and gasket is slightly compressed. Do not force the room to move beyond sealing as damage could occur.

MANUAL OVERRIDE:

Below Floor Slide Out

Should a power failure occur (no 120 volt AC power or the battery loses its charge), follow the listed direction. There is a 1/2" shaft coming through the main rail of the frame. On the end of the shaft is a 3/4" nut attached. Use a 3/4" socket, with an extension and ratchet to move the slide. On some units the stabilizer jack crank will also work on this shaft with the attached 3/4" nut.

Above Floor Slide Out

Should 12 volt power fail and there is no 120 volt AC power available, follow the listed direction. Access to the ram is under the floor of slide, sofa or dinette, is the from the front. Lippert Component System has a smaller motor, less draw and requires a 5/8" socket, ratchet and probably an extension.



King Slide Cable System

In a framework attached to the rear wall are a series of pulleys, cables, and brackets pre-assembled and not visible.

Cables (8) are attached to brackets mounted, one in each corner of slide out leading to adjustable brackets inside of the coach, under a cover at floor level, for adjustment needs to seal in or out position.

Adjustment bracket is attached to a chain, driven by a 12 volt D.C. motor attached to a gear box. Any required adjustment needs are to be performed by a selling or servicing dealer. Electrical system is protected by a 30 amp breaker located in 12 volt fuse panel in the load center.

For 12 volt light, you need to plug power into wall socket on rear wall above slide out. DO NOT forget to unplug light before moving slide in for travel, damage to wiring will occur.

Manually Moving The Room

Locate the flexible shaft in your owners manual. Attach flexible shaft to the 1/4" hex fitting on the end of the motor. Attach 1/4" socket and ratchet to the other end, and turn in the proper direction to move the room. If cables tighten, and motor shaft is difficult to turn, reverse the direction. Over torquing can happen, resulting in severe damage.

Bunk Doors:

To open bunk doors: press top of the hook and pull bottom of lock outward. Grab handle and pull down to 4 o'clock position. Now swing the handle/hinge 180° to allow the bunk door to open. Repeat procedure on opposite side. Swing door downward to bunk position.

Cables inside will hold door in correct position. To close bunk doors: raise door to closed position and swing handle inward 180° under hook and raise up. Hook will go into position by itself. Latches can be locked using correct numbered key on the lock assembly. Weight limit on either front, rear or side bed is 1000 lbs. each.

Tent Assembly:

Tent assembly on your coyote is attached to the frame of bunk door, both sides and top with plastic channel, secured with two, 1/2" screws at the bottom of each side. Sides are secured with molding. Outer part of tent is pulled over bow.

Place tent bow support bar in center of bow with clip and upper end into support bracket above door frame. Support pole has numerous holes to adjust as desired for snug fit of tent, avoiding tent to sag and pocket rain.

Tent has flaps 5 or more with 2 snaps a piece. Attach these to snaps mounted into the door. Place mattress on top as weight of sleeping person will keep bed tight and prevent a small child from falling out of bed. Velcro also holds tent to frame.

The material used to construct the tent is "sunbrella", more of a canvas type, and does breath better then some materials, yet is water retardant. Condensation may exist, depending on weather

conditions, temperature variance, and furnace usage inside the unit, more so at night than day. Such condensation can be reduced or possibly eliminated by opening the upper corner of the bunk end panel 1/2" to 1". Fold over to allow small quantity of air to move across roof panel at the end which has head of sleeping person. See chapter 1 for more information on condensation and causes.

The sewing thread used in construction of your tent is engineered to repel average continuous rainfall for 5-6 hours. It is possible to find a seam leakage in an unusually heavy rain.

Important information on your tent

Two tendencies that you may discover in any tent assembly are condensation and possible minor leakage on first several times used. The first one is condensation, described above and in previous chapter. The second is concerning potential leakage.

Prepare for your first camping trip:

- Set up unit at home to become familiar with method of setup.
- Spray outside of unit with water until thoroughly wet. Allow unit to dry completely. Repeat wet and dry process twice more. This will cause material fibers to close up and threads to swell sealing your unit and therefore preventing leakage.
- Always allow tent to dry completely with bows and braces in place. Storing unit wet promotes mold and mildew and is not an item that is considered warrantable.

ALL VINYL TENTS NEED TO GET WET ONE OR MORE TIMES TO SEAL THE NEEDLE HOLES. Your tent may leak the first time it gets wet. Do not be alarmed. The tent is sewn with special thread that swells up and seals the needle holes after it has been wet. Rubbing a wax candle over sewn seams after the first rain may also assist in quicker sealing.

Prevent Leakage During Use

- Do not rub against walls, roof or canvas windows when wet or when raining.
- Do not place objects against tent walls.
- Do not over extend or over stretch your tent, with items such as pillows.
- Do not spray insect repellent or hair spray on fabric as these items may destroy water repellency of this fabric.

- Do not put tent away in wet conditions. This might be difficult when leaving campsite in raining conditions. Within 48 hours be sure to open tents, set up completely for the tents to dry out.

ALWAYS VENTILATE AND DRY THE TENT WITH BOWS AND BRACES IN PLACE as soon as possible after each exposure to moisture. Mildew is always the result of negligence.

The plastic windows have a -20° cold crack rating. Do not raise the tent up to maximum height in extreme cold (0 degree) weather as the windows may shatter.

TENT SHRINKAGE

All canvas products will shrink when wet. To prevent the shrinkage from damaging the tent, such as pulling seams, loops and material, reduce frame tension when canvas is wet. Re-adjust to normal tension when dry. Tent frame adjustments are made in the tent bow support bar. This bar has numerous holes for adjustment. Canvas should not be stretched completely taut or left under constant tension as damage to the tent may occur.

CLEAING YOUR TENT

- To clean your tent, brush dry with soft bristle brush, or use clean tap water with soft brush, or wash with tap water from hose using spray nozzle. If the fabric had been exposed to salt water, wash with hose using tap water.
- Do not use solvents, soaps or detergents. Do not use aerosol cleaners. If insect repellent is used around the fabric, do not use spray directly on the fabric. An agent used in most sprays, as a propellant, will damage or destroy water repellent finishes (hair sprays, insect sprays, deodorants, etc.) DO NOT touch your canvas while it is raining. It will wick through and appear to make it leak.
- If you have stains or have a certain problem, contact your dealer so he can get back with us before trying solvents that might damage your unit.
- Clean vinyl ends with automotive vinyl cleaner.

Interior Bunks

General bunks, such as in single bunks, in various models have a load rating of 180 pounds per bunk.

CHAPTER 4 SYSTEMS

WATER AND DRAINAGE PLUMBING

Your KZ recreational vehicle has a complete water system, to carry fresh water, as well as holding tanks for used water. Each group has its own explanation along with its own operation.

Fresh Water System

Tanks

Water containers are installed under the coach between frame members and protected with a cover.

Each storage tank has an overflow line. DO NOT install a shut-off valve at lower end of line. If unit had a shut-off valve, and the valve is closed when filling the tank, the tank would split open.

Filling Fresh Water System

Figure 1

To place water into your coach fresh water system use one of these methods:

1. City Water Fill (Figure 1): Water may be received into the system through a direct hook-up referred to as a "city water fill." After attaching a hose to hook-up and supply line, open the faucet from the supply line. Enter the coach and open any faucet to relieve air from the lines. The water heater will fill first before the supply lines. You will experience some air pockets. Allow them to escape before closing faucets.
2. Due to floor plan on these models, there is no standard gravity water fill for storage tank. Near the city water fill, inside of coach, or storage compartment, you will find a valve with a "silver knob." See diagram :

- F** Filter
- P** 12 volt powered water pump
- C** City Water Fill
- S** Siphon Hose
- V** Valves to open/close to control water movement in lines

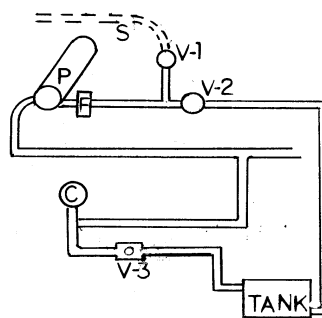



V-1 Regulates "S" Siphon Hose. Should be closed except to draw in water or antifreeze

V-2 Closes line from tank to pump. Will be open during pump use.

V-3 The valve with the silver handle, controls water to the water storage tank. This valve is located between tank and city water fill.

To fill the fresh water tank, leave the hose attached to the city water fill, open V-3 valve, the other two valves need to be closed. Open the faucet for the water supply hose that is attached to the city water fill. Water will now enter the water tank. Do not overfill the tank as it could burst. After tank is filled closed V-3 valve. To use water from the tank open V-2 valve, other two valves need to be closed, use the 12 volt demand pump for your water supply.

	CAUTION
DO NOT leave tank unattended while filling.	
	WARNING
POTABLE WATER ONLY. SANITIZE, FLUSH AND DRAIN BEFORE USING. SEE INSTRUCTION MANUAL. FAILURE TO COMPLY COULD RESULT IN DEATH OR SERIOUS INJURY.	
	CAUTION
Excessive pressure from water supply systems may be encountered in some parks, especially in mountain regions. Water pressure regulators are available to protect your system against such high pressure. A regulator at 45 pound rating is recommended to prevent damage to the plumbing system or components.	

12-Volt Demand Pump

When water is desired and you are not hooked up to city water, your tank will be your supply. On your monitor panel is a switch to turn on the 12-volt demand pump. Energy for the pump is supplied by the auxiliary battery or converter. The pump will self-prime when started, supply water, and continue to run until approximately 40 pounds of pressure is achieved. When pressure drops to 20 pounds, pump will restart. Some cycling in pump may occur. A check valve is built within the pump to prevent water from flowing into the supply tank.

The pump has a small filter attached on the “ in port “ side to prevent any foreign matter from entering the pump. You need to annually or even more often, remove the lower cap and clean it out.

When pump is not in use, turn 12-volt power off at the switch.

Occasionally your water pump may start/stop quickly (within a second). This is referred to as “cycling”. The cause for this annoying noise may be a slightly open faucet, water saver washer in the end of the faucet spout, plus other restrictive issues. If pump cycles every 10 to 15 minutes, there may be a slight water leak somewhere, check valve in city water fill, plumbing fittings, or pressure valve in pump.

Faucets

The basic operation of a faucet is the same as in your home. Open the knobs or raise the single lever. Close faucets when sufficient water volume is achieved. It is normal to experience occasional air pockets in the system.



Bath and Shower

Your bathtub and shower are built with ABS, vinyl, or fiberglass material, similar to those in your home. Shower curtains are provided with the coach and must be used to prevent water from spilling onto the floor, possibly causing damage.



The shower head used in the bathroom has a non-

positive shutoff valve and will drip slightly in shut-off position. A vacuum breaker is also built into the faucet to permit water in hose to drain out as a code requirement.

Before beginning your shower be sure the water heater is lit. Adjust the faucet for temperature before entering the tub or shower. When shower is completed be sure to turn water off at the faucet.

Used water will drain through the plumbing pipes into the gray water holding tank. Remember capacities of your water heater and gray water holding tank. Long showers in a recreational vehicle are NOT suggested due to the amount of water that is available. To conserve water, wet down, and turn water off while you soap up, then rinse.

Outside Spray Port

A convenient Hot & Cold faucet, with a 15' coil hose, and spray nozzle is located on the exterior of the unit. This faucet, hose, and nozzle can be used for exterior washing, and rinsing of hands, utensils or other needs.



This faucet contains mandated backflow prevention. Faucet must be drained for storage or if freezing weather is expected.

To Operate Outside Spray Port

1. Open door.
2. Attach coil hose to faucet quick connect.
3. Open faucet valves, and adjust to desired temperature.
4. To end water usage, close faucet valves and disconnect coil hose.

Fresh Water Line

Two lines, generally red for hot and blue for cold, transport water through out the coach. Valves to direct water flow are near the city water fill or pump area. Connector elbows and tees are plastic or copper, and are held together with compression rings for no leakage.

Low Point Drains

Low point drains are placed on recreational vehicles to drain water lines, tanks, and water heater to prepare coach for winterization and sanitizing systems.

Fresh water supply tanks will have their own separate drains under the floor and/or frame, with a valve to be opened to drain, over flow drain line may be close by.

Plumbing lines also have Low Point drains located in various areas. You may find them (2) for hot and cold coming out of storage areas, outer metal skirt, through underbelly covers, control centers, etc. Water should always drain out to the ground, not into underbelly cover.

Sanitizing and Filling the Potable Water System

For your safety, you should sanitize your potable water system when your recreational vehicle is new or when it has been sitting unused for a period of time and it may have become contaminated.

Prepare a chlorine solution using 1/4 cup of bleach (5% sodium hypochlorite solution) to one gallon of water. Prepare one gallon of this solution for each 15 gallon capacity of the tank. As designed and constructed, this method will sanitize the plumbing system.

For Direct Fill-City Water or Storage Tank:

1. Close all the drains: tanks, lo-point drains, and have by-pass closed to water heater.
2. With the coach completely drained, open V1 and insert siphon hose into container with sanitation solution. Valve V-2 and V-3 need to be closed. Start the pump to draw liquid into the system until liquid comes through the faucets. Close faucets and pump will shut off. Lines are now full.
3. Should you desire to sanitize also the tank, open V-3 valve, close V-2 valve, V-1 valve remains open with siphon hose still in container of sanitation liquid. Start the water pump which will draw the sanitation solution into the water tank.
4. Now close V1 and V2. with V3 open, add additional water to tank through the city water fill. Open faucets for free flow of water through system.
5. Allow this water solution to stand in the system for three hours.
6. Drain solution and flush with fresh water.
7. To remove any excess chlorine taste or odor, prepare a solution of one quart vinegar to five gallons of water and allow this solution to agitate in the tank for several days by vehicle motion.
8. Drain the tank again and flush with fresh water.
9. Your demand water system is now ready for use.
10. Be sure to TURN OFF the pump when traveling or when the recreational vehicle is not in use.

Your water system is now ready to be used.

On slide outs containing kitchens will have flexible hoses installed on both fresh water lines and drain lines. Make sure there are no obstructions to prevent free flow preventing leakage and full flow.

Drainage (Fresh Water)

All permanent fresh water tanks can be drained. The type of drain used is a turn valve with open/close position. This valve is located under the floor underbelly.

To drain the supply lines and the entire system, you need to follow the steps listed below. Locate the valve placed at the floor level or close to the floor, found under the dinette, storage cabinet, and sofa. These valves will be at the "lowest" point of the water lines.

To drain system:

1. Open all faucets including optional exterior spray port.
2. Open the fresh water tank drain.
3. Open the water heater drain.
4. Open all (two to four) low-point drains.
5. Open the toilet valve, hold or block if need be.
6. To empty the pump, start and allow to run up to 20 seconds.

Sanitation System

Toilets

The toilet used on the MXT models is the Aqua Magic V, hand flush model. This toilet has two levers for flush operation.



Prior to using your toilet, be sure to add a proper amount of deodorant chemical into the toilet with water. Flush contents into tank plus two or three gallons of water.

After each flush, about two inches of water will be in bowl, which is fine for travel. For best operating function, keep four to six inches of water in the bowl. This assists flushing procedure. Always flush for ten seconds or more to ensure all solids and wastes move into tank and are not held in drainage pipes.

OPERATION: Note the following photo for hand lever operation. To flush, press lever all the way forward as shown. To add water press lever half way forward.

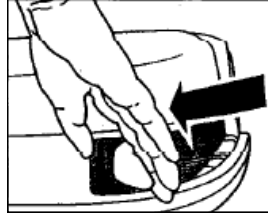

Unlike the toilet in your house which uses four to seven gallons of water per flush, a recreational vehicle uses two to three quarts to save water and space. When insufficient water is used during flushing, waste materials may not evacuate properly from drain lines to tank, causing "clogging" in pipe.

When hooked up to a sewer drain at a camp ground, ALWAYS keep the termination valve CLOSED until the tank is at least 3/4 full. This will provide sufficient water to assist in complete draining of tank.

Manufacturer of toilet, Thetford Corp., offers a complete line of deodorants, chemicals, and other convenience products for your use. Your dealer can assist you with these needs and may already have them in stock.

	<h1>CAUTION</h1>
<p>NEVER leave the gate valve of your coach's sewage tank open when hooked up to a park's sewer system. Open only when you wish to drain system.</p>	

Using Toilet and Tank System

When camping you should always have 4 to 6 inches of water in the toilet bowl. The toilet system performs better when you run water 10 to 20 seconds after flushing to ensure wastes will proceed to the bottom of the tank. Unlike your toilet at home which uses four to seven gallons per flush, the average recreational vehicle system uses two to three quarts. If there is not sufficient water used during flushing, waste materials may not evacuate properly from drain line to tank. Tank and pipes could eventually become clogged.

Vents

A very important part of your sanitation system is the vent system in your coach. These vents release air from holding tanks allowing water to enter. Vent pipes are attached to the holding tank, go

through the walls and cabinets to the roof. On some models a portion of vent pipe may be part of the drainage system referred to as a “wet vent”. As air flows upward, water will be draining downward.

Holding Tanks

The final parts of your sanitation system are the holding tanks for waste materials and water. These are located below the floor of your coach.

Gray Tank. Waste water from the bath tub, shower and sinks will drain into this container. No special preparation is required, however, you may wish to add baking soda or a Thetford chemical to reduce odors from food particles in the system.

Waste Tank. The toilet drains into the waste or “black” holding tank. For correct preparation follow the listed steps:

1. Release two quarts of water into the toilet bowl.
2. Place the recommended quantity of chemicals for waste holding tank as per instructions on the bottle into the toilet bowl.
3. Flush liquids into the tank and allow up to two gallons of water to flow into the tank.

Each time you drain the tank, you should follow the above instructions before using.

All drain pipes will have a “P-trap” installed into each line. Water in these traps prevent odors from escaping into the coach. During travel, water from the P-traps may spill and permit odors into the coach. These odors come from fats and food particles decomposing in the tank. By adding water and using a RV approved deodorizing agent, contents will dissolve faster, keeping the drain lines and tanks clean and free flowing. These chemicals are available at a RV supply store.



CAUTION

It is important to use adequate water to flush and have several gallons of water with chemicals in the tank. This helps the flow of wastes and reduces solid waste build-up.

Draining the Tanks

A final part of your sanitation system is the drainage of holding tanks. Realizing dump stations will vary, place the coach as level as possible to make drainage easier. Some tanks drain from the center requiring level or slightly up in front. Others will drain from end permitting a slight tilting to the side which drains are on.

Remove the cap and attach the adapter onto the valve housing. Turn the adapter 10° to lock onto the pegs. Attach a flexible sewer hose to the adapter and secure with a clamp. Place the other end into the approved sewer system.

You may now open the 3 inch drain valve to drain the sewage tank first. Open the valve on the gray water tank last to utilize water to wash and rinse the hose and drain lines.

Most states and parks have strict laws and regulations to prohibit dumping of wastes of any kind into anything other than proper disposal facilities or sewer systems. Almost all privately owned parks have either a central pump facility or offer a campsite hookup for sewage. You can find lists of many dump facilities throughout the United States in *Woodall's*, *Rand McNally Camp Guide*, *Good Sam Camp Guide*, *KOA Campgrounds Camp Guide*, or various other publications. Some fuel stations also have dump stations.

Flush System

The flush system is designed and built to rinse the waste holding tank, after waste tank has been drained completely of water and solids. This flush system is available as an option on the MXT units.

1. Attach a fresh water source to the connection marked "Sewer tank Flusher". Be sure termination valves are open on tanks.
2. Open valve to release water into tank for rinsing and cleaning of your waste water holding tank.
3. Rinse for several minutes to remove any foreign matter from tank, and probes.

Remember the moisture content may give you a false reading on your monitor panel indicating it is full. Allow time to dry out tank or recharge for next usage.

Maintenance for Holding Tanks

The following maintenance is recommended by our holding tank suppliers to keep your tanks clean and keep the probes free of debris and build-up.

Gray (Waste-Water) Tank. Fill tank with 8-10 gallons of warm water. Add a degreaser such as a citrus cleaner or Dawn dish soap. Leave solution in tank while you are traveling. Rinse and drain tank.

Black (Sewer) Tank. Fill tank with 8-10 gallons of water. Add one bottle of drain cleaner, such as Drano or Liquid Plumber. Leave the solution in tank while traveling. Rinse and drain tank.

.Heated Holding Tanks. Method used to distribute heat is by placing holes from tank compartment into heat duct built into floor, allowing warm airflow throughout tank area

	<h1>WARNING</h1>
<p>DO NOT use Ethylene Glycol (automotive antifreeze) or Methanol (windshield washer antifreeze) in your fresh water system because they are harmful and may be fatal if swallowed!</p>	

Winterizing Your Recreational Vehicle

Preparing your trailer for cold weather is very important for most states and Canada. Failure to prepare your coach for cold weather will cause the water systems to freeze resulting in breakage. Damages related to freezing are not covered under the terms of your limited warranty.

Two methods of winterizing your coach after draining and flushing your drainage system are as follows.

Method 1:

1. Open all faucets, low point drains and toilet valve to drain all water. Leave these open during this procedure.
2. Start pump and operate until all water has been removed, takes about 10 to 15 seconds.
3. After water has been drained, use an air hose from compressor and an adapter attached to city water fill. In about 3 to 5 minutes all water will be blown out of system.

4. Pour one (1) cup (12 oz) of non-toxic RV anti-freeze into each P-Trap. Each sink has a P-Trap as does the bathtub.

Method 2:

The water heater bypass kit is designed and built to avoid having antifreeze in the water heater.

1. Turn off the pump.
2. Drain the water heater and the entire water system.
3. Close the valve on the bottom and top of the by pass kit to prevent liquid from entering the water heater.
4. Place siphon hose into container with anti-freeze.
5. Open the valve (V-1) on the siphon hose. Valve V-2 and V-3 from diagram on page 47 need to be closed. Open all faucets.
6. Turn on the pump to supply the fresh water system with anti-freeze. It will take 2 gallons or more, depending on the size of the coach.
7. Allow lines to be filled and, then close faucets. Pour some anti-freeze into each sink and bathtub drain to winterize the P-Traps.
8. Shut off the pump. You may wish to re-open the faucets to remove pressure from the water lines.

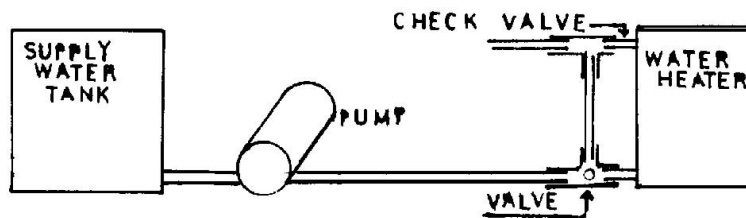

Valves in horizontal position allows water to flow into and through water heater and from water heater upon demand. Valve on bottom and top portion of by-pass, are choice directional flow valves, not shutoff valves.

When bottom valve is in vertical position it will prevent water from flowing into water heater. Valve on top of by pass kit, when in vertical position, will not allow back flow into water heater. Now you can send anti-freeze liquid through coach plumbing system without filling water heater.

Using the Water System During Freezing Weather.

Your towable RV was not intended to be used during freezing weather unless special precautions are taken. Water freezes at 32 degree Fahrenheit in campgrounds or at home.

There is no product that can be added to the water to ensure freeze protection when the system is in use, other then RV anti-freeze. DO NOT drink water which contains anti-freeze.

PROPANE FUEL SYSTEM

The fuel system in your recreational vehicle has numerous components such as, piping, copper tubing, brass connectors, hoses, regulators and appliances. Each of these components will be explained in its appropriate area.

Propane is the only fuel permitted to be used in a recreational vehicle and its appliances. This product is refined from crude oil through natural gasses. An agent has been added for detection should a leak occur or a valve accidentally be left open. It is important for a recreational vehicle owner to recognize and identify the smell of propane vapor.

Butane cannot be used since its boiling point is 30°F. This fuel will not flow in freezing temperatures.

Natural gas and methane CANNOT be used in any KZRV or it's appliances.

Propane fuel is stored in liquid form under high pressure in special containers. Boiling point is 44°F, the temperature when vapor ceases to flow. Fuel will change to vapor when released from the container. Appliances are not designed to operate with liquid. Liquid will damage o-rings in valves and also leave sticky, oily residue causing poor or no operation in the regulator.

Propane Container

The propane cylinder is D.O.T. approved container to hold liquid under high pressure, normally a 20 or 30 pound capacity.

The open/closing valve, referred to as an acme cylinder valve, is to be closed at all times unless hooked up to a propane system or when filling the container.

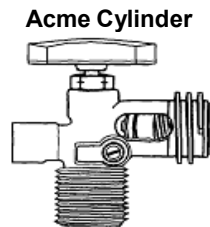

At any point a container is disconnected, BE SURE to install the "dust cap" over the acme valve. This cover is required by the RV Industry Gas Association, the container manufacturer, and is for your safety.

Whenever the container is detached from the propane system, DO NOT allow the cylinder to move or roll around during transporting to and from the gas supplier.

A second smaller valve is built into the main valve to prevent fuel from escaping. A hose with an acme fitting or a POL fitting must be completely and tightly installed before gas vapor can be withdrawn.

This valve, also referred to as an OPD valve (overfill protection device) has a float device inside of the cylinder to prevent overfilling of the container.

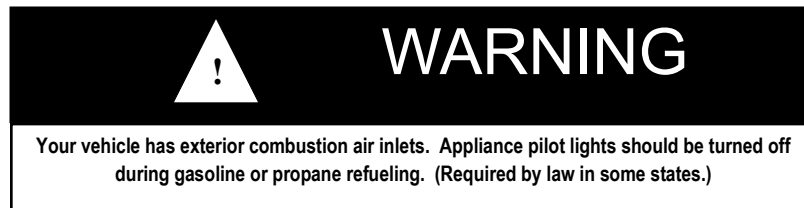

Servicing and Filling Propane Containers

Filling a propane container must be done carefully and correctly. Only a qualified person, properly trained on inspection, filling and safety procedures, should fill containers.

To remove the propane containers for refilling.

1. Remove the bottle covers, if used.
2. Close the main valve on the container.
3. Remove the two hoses at the ACME connection.
4. Install the rubber cap over the valve—ACME connection.
5. Remove/loosen the wing nut holding the clamp hook.
6. Remove the clamp hook.
7. Fill the bottle and reverse the procedure to install. Test all connections for leakage.

A new container must be “purged” before placing into service and must NEVER BE OVERFILLED. Purging is an operation performed by your dealer or propane agency to remove any atmospheric air. As an owner you need not be concerned regarding this procedure unless you permit the valve to be in OPEN position when empty.

Two overfill devices are built into the valve to prevent overfilling of the container. First, is the small brass “knob” or “screw” inside of the valve. This “10% valve” must be open when filling, allowing air to escape. When the container reaches 80% of the correct capacity, liquid appears. Shut the supply filling valve off. Close the 10% valve plus the top handle of the main valve.

Secondly, containers with OPD valves have a float on the inside that

automatically shuts off liquid flow when the 80% capacity has been reached.

DANGER

ALL PILOT LIGHTS, APPLIANCES AND THEIR IGNITORS (SEE OPERATING INSTRUCTIONS) SHALL BE TURNED OFF BEFORE REFUELING OF FUEL TANKS AND/OR PROPANE CONTAINERS. FAILURE TO COMPLY COULD RESULT IN DEATH OR SERIOUS INJURY.

When refilling propane containers, they are generally removed from propane compartment or tie downs. BE SURE to reinstall correctly, as shown in installation instructions, and test for leaks.

When propane containers are filled to 80% level there is available space for safe expansion of the vaporized liquid. Should your container become slightly overfilled, pressure may rise due to hot sun.

It could cause the overflow valve to “blow-off” and emit a small quantity of propane vapor. This can be detected by a strong odor around tanks. Keep open flames away from this area. It is best to remove the bottle, take it to a safe area, and “bleed-off” the excess pressure by opening the valve slightly and closing it when discharge has been sufficient, one to two minutes.



WARNING

A warning label has been located near the propane container. This label reads as follows:

DO NOT FILL CONTAINER(S) TO MORE THAN 80 PERCENT OF CAPACITY.

1. **Overfilling the propane container can result in uncontrolled gas flow, which can cause fire or explosion.**
2. **A properly filled container will contain approximately 80 percent of its volume as propane.**

When disconnecting propane containers, you must turn the acme fitting in a clockwise direction because left-hand threads are utilized. When reconnecting, turn connections counterclockwise. Connections must be tight, however DO NOT over-tighten.

	CAUTION
DO NOT use tools to open or close the tank valve. HAND TIGHTEN ONLY to avoid damage to the valve or handle.	

	WARNING
Never smoke during the filling of propane tanks. Keep the recreational vehicle away from immediate filling area when possible or extinguish all gas	

Installing Propane Containers

KZ recreational vehicles are equipped with 20 or 30 pound propane containers, depending on floor plan models. Mounting and attaching instructions are listed below.

1. Thread the long rod into the base plate.
2. Set both bottles into place as shown on page 68.
3. Drop the double hook bracket over the rod and hook onto the bottle.
4. Attach the wing nut to hold the bracket and tighten to hold the bottle to the plate.
5. Attach the regulator with the vent down to the bracket.
6. Attach the main hose from the regulator to the manifold fitting in the frame.
7. Attach two short pigtail hoses to the regulator and bottles at the ACME fitting.
8. Test all propane connections for leakage.

	WARNING
Propane cylinders shall not be placed or stored inside the vehicle. Propane cylinders are equipped with safety devices that relieve excessive pressure by discharging gas to the atmosphere.	
FAILURE TO COMPLY COULD RESULT IN DEATH OR SERIOUS INJURY.	

1. Knob to open and close main valve.
2. Complete valve assembly.
3. "10% valve", (small brass knob or slot screw).
4. Container mounting stand.

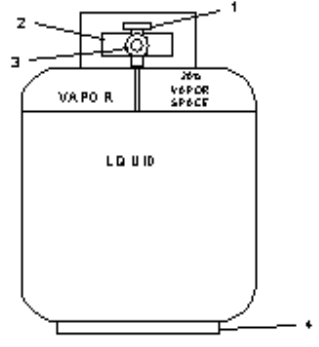

A warning label has been located near the propane container. This label reads as follows:



CAUTION

THIS GAS PIPING SYSTEM IS DESIGNED FOR USE WITH PROPANE ONLY. DO NOT CONNECT NATURAL GAS TO THIS SYSTEM.

Securely cap inlet when not connected for use. After turning on gas, except after normal cylinder replacement, test gas piping and connections to appliances for leakage with soapy water or bubble solution. Do not use products that contain ammonia or chlorine.

ALL GAS LINES HAVE BEEN CHECKED WITH AIR PRESSURE. DEALERS ARE REQUIRED TO RECHECK BEFORE DELIVERY TO RETAIL CUSTOMERS.

Regulator

Propane regulators must always be installed with the regulator vent facing downward. Regulators that are not in compartments have been equipped with a protective cover. Make sure that the regulator vent faces downward and that the cover is kept in place to minimize

vent blockage that could result in excessive gas pressure causing fire or explosion.

The regulator has the only moving components in the propane system. It's sole function is to reduce the high and varied pressure from the propane containers to safe and consistent low operating pressure. The small inlet is the first stage, which reduces the container pressure to 10-13 pounds.



The second stage then reduces the 10-13 pound pressure to an operating pressure of 11 inches w.c. (water column) or 6.35 ounces of outlet pressure to your appliances. The second stage is adjustable and may need to be adjusted for precise operation. We suggest this to be normal maintenance and performed once per year. Do not make this adjustment without a manometer. This instrument is required to read actual pressure.

If pressure is too high, it affects performance and safety. Should pressure be too low, appliances will not operate correctly. An authorized and competent technician with proper equipment should perform such tests and adjustments, as may be required.

Two types of propane regulators are used on KZ products. First, is the standard two stage regulator with a brass T-check connector to mount two propane bottles. We suggest opening only one bottle at a time. Should you open both bottles, they will draw vapor together, resulting in both tanks becoming empty at the same time. This standard regulator is used on smaller coaches.

The second type is the "automatic" two stage regulator used on larger coaches. With both cylinders full of propane, turn the lever on the regulator towards the cylinder you wish to use first. This will now be the "supply" cylinder and the other "reserve". Slowly open both cylinder valves.

The indicator on top of the regulator will turn bright green. When the cylinder becomes empty the indicator will change to bright orange.

Now turn the lever to the side of the full bottle and the green signal will return. You may now remove the empty bottle to have it refilled without interrupting the flow from the full bottle. After filling the cylinder, connect the pigtail hose and slowly open the bottle valve. Do not forget to check for leakage each time you refill cylinder or disconnect any part on the propane system.

High Pressure Hoses with Acme Connectors

Propane leaves the container through a hose with an acme connector attached to the bottle, also having a “flow-limiting device”. Should the container valve be opened too quickly this device may close, stopping the flow of propane. This device is designed to equalize propane pressures in about 5 seconds, generally being unnoticed. All pilot light valves must be turned off for equalization of pressure to occur.

Main Supply Hose – Low Pressure

The main supply hose will be attached from the regulator to the brass manifold fitting in the frame of the coach. The swivel brass nut on the main hose will be your final attachment.

There are several things to remember each time the container is removed:

1. Be sure ALL fittings are tight. Always use two wrenches for brass connections.
2. Be sure ALL connections are tested for leakage.
3. Open the main valve slowly to avoid a fast rush of gas to flow-limiting device causing gas “freeze”.
4. Listen carefully – a “hissing” sound longer than one second may indicate a gas leak. Close valve and search for leak.



**3/8" MPT x 1/2" Female
Flare Swivel**

Should you experience a gas “freeze-up”, close the main valve and wait 15 minutes before trying again. Keep the container valve(s) closed when traveling. Some states prohibit traveling with the propane container valves open, especially in underground tunnels on expressways.

Operation

After the camper is completely set up and you are prepared for camping enjoyment, follow these steps for propane operation.

1. Be sure ALL burner valves, controls, and pilot light valves are closed.
2. Open main valve on propane container slowly to avoid a fast rush through excess flow valve causing "propane freeze".
3. Listen carefully as propane begins to flow. If a "hissing" sound is heard for more than one or two seconds, close valve and search for a potential leak.
4. Light appliances as needed and directed in Chapter Five - Appliances.

	<h1>WARNING</h1>
<p>IT IS NOT SAFE TO USE COOKING APPLIANCES FOR COMFORT HEATING. Cooking appliances need fresh air for safe operation.</p> <p>Before operation:</p> <ol style="list-style-type: none">1. Open overhead vent or turn on exhaust fan.2. Open window(s). <p>FAILURE TO COMPLY COULD RESULT IN DEATH OR SERIOUS INJURY.</p>	

Checking for Leaks

The entire propane distribution system and appliances have gone through complete factory and dealer tests for any leakage. When traveling with your RV normal vibrations and road movement may cause connections to loosen and develop leaks.

For normal maintenance we advise all owners to test for leakage at least once per year or more often. You may request your dealer to perform a maintenance check each spring.

Should you encounter an odor, possibly propane, turn off any and all open flames and begin a systematic search for leaks on the complete gas system. NEVER USE A MATCH. Use a soapy water solution which contains NO AMMONIA, or CHLORINE content to check for leaks. If a leak is identified, bubbles will appear. AL-

WAYS use two wrenches when tightening brass connections to prevent twisting of copper.

	DANGER
If You Smell Gas:	
<ol style="list-style-type: none">1. Extinguish any open flames, pilot lights, and all smoking materials.2. Do not touch electrical switches.3. Shut off the gas supply at the tank valve(s) or gas supply connection.4. Open doors and other ventilating openings.5. Leave area until the odor clears.6. Have the gas system checked and leakage source corrected before using again.	
FAILURE TO COMPLY COULD RESULT IN EXPLOSION RE-	

	WARNING
Portable fuel-burning equipment, including wood and charcoal grills and stoves, shall not be used inside the recreational vehicle. The use of this equipment inside the recreational vehicle may cause fire or asphyxiation.	

For your own protection, the preceding warning labels has been placed near the cooking area to remind you of the need of oxygen for combustion and breathing. Due to smaller area in your recreational vehicle, there is less oxygen than in your home. Proper ventilation is required when cooking.

It is especially important that cooking appliances **not be used for comfort heating**, as the danger of asphyxiation and unsafe levels of carbon monoxide are greater when the appliance is used for long periods of time.

Propane Consumption

All your propane appliances are operated intermittently. Your furnace is naturally the appliance using the most fuel, especially if freezing conditions are present outside. On a very cold and windy day it is conceivable that your coach could consume most of a 30 pound propane bottle.

Propane consumption depends mostly upon individual use of appliances and the length of time operated. Each gallon of propane produces about 91,500 BTUs of heat energy. Following is a list of typical appliance consumption when turned on fully for one hour of operation:

APPLIANCE	LP GAS CONSUMPTION
Water Heater	8,800-12,000 BTU
Furnace	20,000-35,000 BTU
Stove/Oven	6,500-9,100 BTU
Refer	1,200-2,200 BTU

Note: The above chart represents many different models.



CAUTION

If you have double bottles and a standard regulator on your RV, use only one bottle at a time. Otherwise the gas supply will be drawn equally from both bottles until supply has been totally exhausted. Using one bottle until it is empty, then using the second bottle will allow you to fill the empty bottle at your convenience without being totally out of propane.

ELECTRICAL SYSTEM

General Information

The electrical system in your recreational vehicle is designed for using both 120 volt AC (alternating current) and 12 volt DC (direct current) capabilities. All installations and designs are built to comply with safety requirements of ANSI standard A119.2, National Electric Code and Canadian Standards Association.

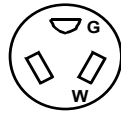

30-A, 125-V, 2-pole, 3-wire, grounding type

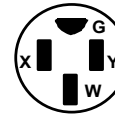
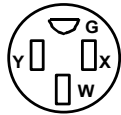

50-A, 125/250-V, 3-pole, 4-wire, grounding type

All coaches manufactured by KZRV have 30 amp, and some units have optional 50 amp service available.



CAUTION

A 50 amp service is a 240-volt hook-up. There is no appliance or other component requiring 240 volts in this coach. For more information, see the section later in this chapter, 50 Amp (Optional).

Highly recommend that your RV electrical connection, is not plugged into a household outlet.

Changes and Modifications

Any changes, alternations, additions, and/or modifications need to be performed by qualified electrical technicians, using only approved components which meet safety and code requirements. This includes owners, dealers, etc. who desire to make changes. The manufacturer is not responsible for any changes, or alterations, made to the 120 AC system of the coach.

120-Volt A/C System

Power Cord 30 AMP or 50 AMP

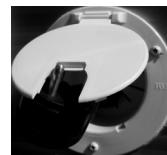

For units with the 30 amp rated power cord that is pre-wired into your 120 volt AC breaker box. Open the hatch door on the exterior of the unit. Pull cord out and attach it to 120 volt power source.

For units that have 30 Amp or 50 Amp power cords that are detachable from the inlet connection as shown, the cords are to be stored inside of the unit when not in use. This cord places 120 AC volt power into your breaker distribution center, as built into your coach.

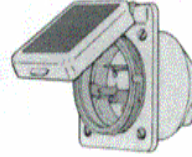

Energy will enter through the main breaker and is distributed through circuit breakers to the wall receptacles and appliances. This power cord will be approximately 26 to 28 feet in length. Each cord has the correct gauge of wire to carry the correct voltage to the coach.

In some hookups the power cord may not be long enough and extension cords are required. Always use a cord with the gauge of wire equal to or greater than the power cord. Should you use a cord with a smaller wire gauge, overheating, loss of amperage, and possible melting could occur.

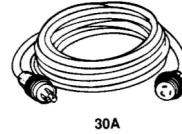

30A

DO NOT leave any unused portion of an extension cord in a "coil" as it may overheat, short-circuit wires and potentially destroy your extension cord.



50A



WARNING

Never use a "cheater" plug or extension cord which breaks the continuity of the ground circuit to the grounding pin.

Circuit Breakers and Box

On a 30 amp system, a maximum of five distribution circuits are permitted. All breakers are sized according to power needs on each line.



WARNING

Do not replace breakers or fuses with any that are rated at a higher amperage. Over fusing may cause a fire by overheating the wire.

The following generic drawing shows the circuit breaker alignment with number one being the main breaker on all floor plans. Depending on the size, floor plan and options of your coach, circuit three through six will vary and possibly not all circuits will be used. Number two is generally the 20 amp air conditioner circuit.

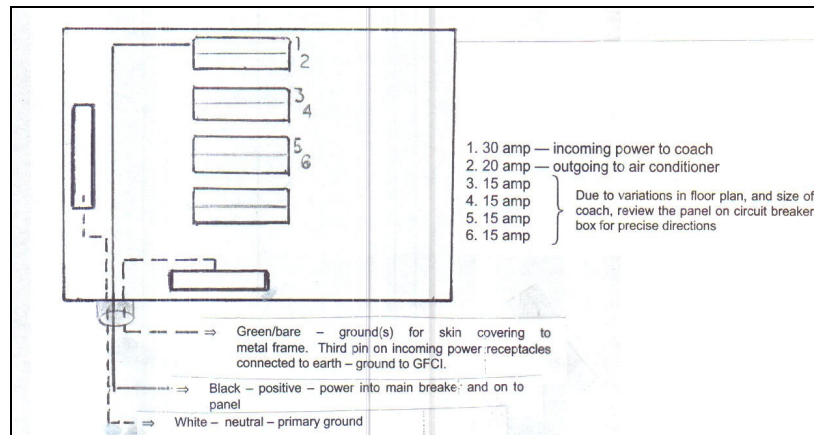

! WARNING

NEVER, under any circumstances, remove a grounding pin in any cord or plug. It may mean the difference between LIFE OR DEATH.

An owner must realize and understand that a coach has a total of 30 amp service available to be used. Conserving and choosing which appliance has priority in consumption needs to be part of the planning.

Don't forget loose items such as toasters, electric skillet, and coffee pots also consume power. Include these also in your planning. 50 amp service provides another option.

50 Amp (Optional on some units)

On some larger coaches more appliances that require more 120-volt AC power are desired by owners. Availability of 50 amp service is the best method providing you have 50 amps of incoming power, if this option is available on your unit.

For this application a larger circuit breaker box is required as there are two separate banks of 120-volt AC power on the positive position. Each positive bank receives a 120 volt wire marked "X" or "Y" plus a white neutral wire and green/bare ground to complete circuitry.

Actually these two positive wires added together are 240-volt AC service yet serve two separate banks as the external sticker indicates. A 50 amp main breaker will distribute current to separate banks, verifying 240 volts are present. There are no 240 volt appliances in this coach.

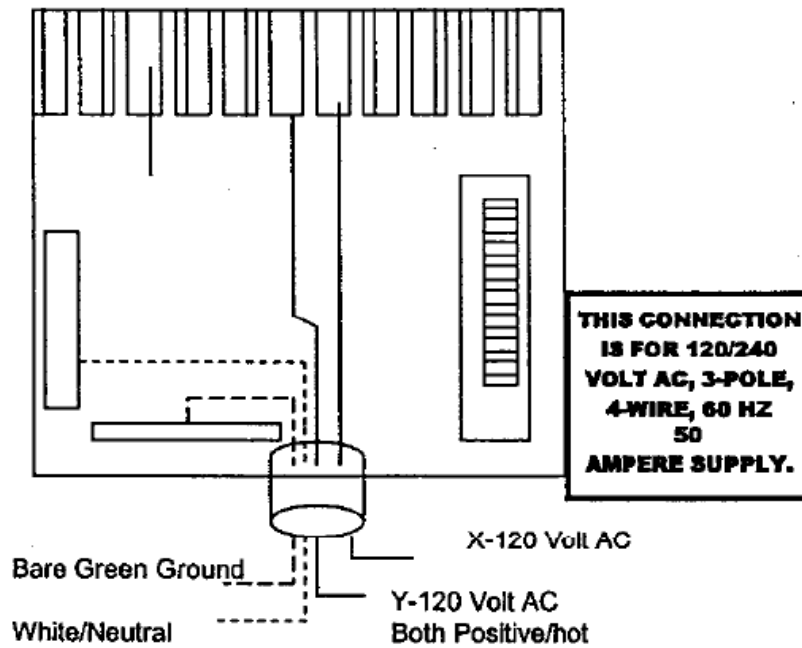

If use of a "reducing" adapter or pigtail is needed because 50 amp/ four prong service is not available, several things must be remembered.

1. A "reducing" adapter prevents you from using 50 amp service as designed, permitting only 30 amps to enter.
2. Using a "pigtail" adapter may imply a 240-volt AC hookup, which would cause damage to appliances because 120-volt positive power would be fed through white/neutral wire.



WARNING

DO NOT connect 240 volt direct power to the coach through a reducing adapter. By doing so, “positive” power will be sent through neutral/white wire damaging appliances.

GFCI Protection

Each coach has a GFCI, Ground Fault Correction Interrupter, protection receptacle installed into the circuitry. This GFCI device is designed to protect people from hazards of line to ground electric shock. The purpose is to reduce possible injury caused by electrical shock, resulting from faulty insulation, improper polarity and related to moisture and/or earth ground.

The third “round” pin on the receptacle is very important for this safety device to function correctly. NEVER cut off this pin. When using an appliance in the receptacle without this provision, use an adapter with a pigtail to be attached to the receptacle box to complete the circuit.

This GFCI receptacle will not protect against short-circuits or overloads. The circuit breaker or fuse in the electrical panel which supplies power to the circuit provides this protection.

Polarity is extremely important. You should be certain that the polarity of the external power is not reversed, in order to avoid harm to appliances and personal electrical shock. Polarity testers may be purchased in most electrical and hardware stores with the GFCI tester built in.

During use of the recreational vehicle it is suggested to test this receptacle once per month. To test press the “TEST” button in. The “RESET” button should pop out. Power should now be turned off at this receptacle and any receptacles down line. To restore power push, then release the “RESET” button.

12-Volt DC System

Most interior lights and appliances receive 12-volt DC power through converter output and/or the auxiliary battery. Exterior lights and

brakes also use 12-volt DC power from the tow vehicle battery and/or auxiliary battery through the seven way connector and wire attached to the tow vehicle. Following are explanations of various items.

Converter

The heart of your 12 volt DC system is enclosed inside of load center, including 12V fuse panel, 120V breaker panel and converter.

Fuse panel may have 6, 9, 12, 15, or 20 fuse positions, depending on output size of your converter.

All converters have solid state electronic components internally to produce "clean" 12V DC power.

This load center will have a brown plastic front with a small door to access fuses and breakers.

Some models have fuses and breakers in a distribution box, with converter installed in a different location (not mounted into distribution box).

The function of a converter takes 120-volt AC power and transforms this energy into 12-volt DC power as used in your coach. 12-volt DC supplies power for some appliances and most interior lights. The floor plan and size of coach indicate the output size.

When the converter receives 120 AC power, it transfers power into 12-volt DC without any manual switches. The converter also charges the auxiliary battery(s) when installed on the coach and attached to 120-volt AC power. The third function of a converter is to send 12-volt power to the fuse panel and throughout the coach.

Each converter has a "built-in" fan which operates through a load sensor control or temperature sensor. As more current is drawn, fan will speed up, run faster, or slow down, based on amp draw and/or temperature. Should the fan not run at all, the converter may overheat and will cut-out and/or stop.

Auxiliary Battery (Optional on Some Units)

All travel trailers and fifth wheels are pre-built to accept a battery. Batteries are not standard equipment, nor are they an option. To purchase battery, contact your dealer, or battery center.

Recommended batteries are of deep-cycle type as you need longer, slow consuming power rather than cold-cranking power. A battery is always required for a break-away switch to function.

A battery requires routine maintenance for long life. First, terminals need to be kept clean to avoid corrosion. Second, a battery used daily will consume water as long as the converter is in operation. Be sure to check the battery no less than every 30 days and keep the battery filled with distilled (rain) water. Most good deep cycle batteries are NOT maintenance free.

A converter will not overcharge a battery unless a battery has a dead cell, or the converter has a malfunction. Some type of converters have full battery charge shut-off. Other types reduce the rate of charge as battery conditions reach 12.7 volts DC or 1.265 specific gravity at 80°F. By electronic standards, a battery is discharged at 10.5 volts. Dropping voltage lower than 10.5 volts will begin damaging plates in the battery.

The interior lights will operate from the converter and/or auxiliary battery. Some lights will have wall switches and other lights have switches in the lights themselves.

Circuit Breakers and Fuses—12 Volt DC

These two items have been installed in your coach to protect circuitry and components:

Fuses are placed into the fuse panel with the converter or into a separate panel near the converter with access inside of coach. Fuses are placed in your electrical system to protect wiring and components when overloads appear or short circuits occur. Radios, stereos and possibly other components may have “in-line” fuses attached to their own wire harness.

Circuit breakers are placed at several locations. An automatic reset breaker is placed within 18 inches of the auxiliary battery. This breaker will automatically reset upon “cool down”, normally within 60 seconds.

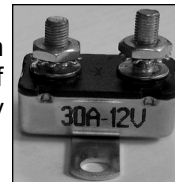

A green (30) amp, gold (20 Amp) or red (10 Amp) automatic reset breaker is installed in the load center to operate your slide-out(s).



WARNING

DO NOT replace circuit breakers or fuses with a higher current rating than those supplied with your coach. Over-fusing can cause a fire hazard by overheating the electrical wiring.

All wiring used in your coach meets correct amp rating correlated with fuses and breakers in respective panels as required by code.

The RV battery is placed in parallel circuitry with the battery on your tow vehicle. Care needs to be exercised not to drain both batteries together. There are two methods of avoiding this condition:

First, disconnect the tow vehicle when parked and/or using your coach.

Second, a battery isolator may be installed in your tow vehicle to prevent power drain from batteries in both vehicles. This device "isolator" has two useful purposes. First, it sends current from the alternator to both batteries simultaneously. Secondly, the isolator prevents draw from the recreational vehicle through the battery of the tow vehicle, preserving power to start the engine.

Contact your dealer should you desire an isolator for your protection. Two types are available, mechanical type, or solid state which is the best and most expensive.

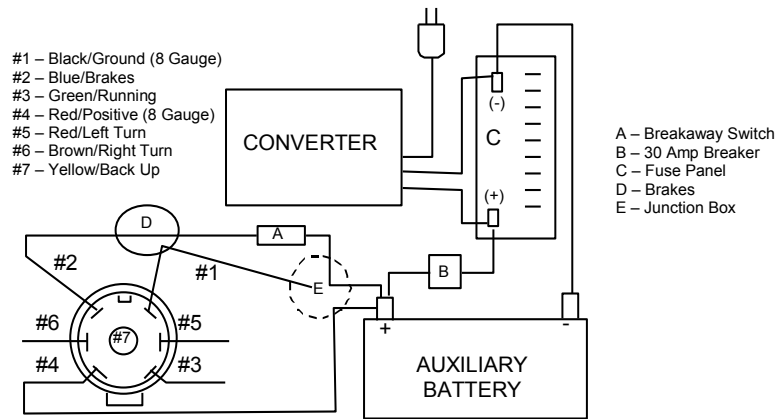

Exterior Lights and Connector, 12 Volt

Power for exterior lights, such as tail lights, turn, clearance and brake lights, is supplied by the tow vehicle.

Note the diagram (above) showing the color code and numbers from the seven way connector and how power is fed to the exterior lights. The positive red wire is attached to the battery to transfer power to the coach.

The connector between the recreational vehicle and the tow vehicle may build up corrosion due to moisture. You may need to clean these terminals occasionally to insure good electrical contact.

Porch Lights

Porch lights are placed on sidewalls, left and right side. Switches for these lights, depending on models, will be in the interior, right and possibly left sidewall. Occasionally, the switch will be on the light itself.

Brake Wiring

Both 10 and 12 inch electric brakes operate on 12-volt power supplied from the tow vehicle, transferred through the blue-positive and white-negative in the seven way harness. There are no fuses or breakers installed in this brake wiring. More information on the brake system is found in Chapter Three - Using Your RV.

If experiencing any electrical problems, check the following items, fuses, breakers, and connections. If none of these resolve the problem, contact your dealer for trouble shooting and needed repairs.



CAUTION

Any electrical installation that does not meet the criteria of the manufacturer's specification will VOID THE WARRANTY on the electrical system.

CHAPTER 5 APPLIANCES

KZRV places brand name, quality-built equipment, as guided by current codes and standards, in all recreational vehicles. Some appliances are built and equipped to operate on propane gas ONLY. DO NOT attempt to operate on natural, butane or methane gas.

Each appliance has its own specific manual, written and published by its manufacturer. These manuals supply additional information about the appliances in your recreational vehicle.

FURNACE

The furnace in your recreational vehicle requires 12-volt DC electrical current and propane gas energy for correct operation. The furnace receives 12-volt DC power from a fully charged battery and/or the converter in the coach. This power must be present before propane gas can enter through the control to the burner tube.

The combustion chamber is completely sealed to prevent any carbon monoxide from entering into the coach. Oxygen is drawn into the chamber through the upper vent and exhaust fumes expelled through the lower vent.

Your basic operation is performed through one of two types of thermostats shown.

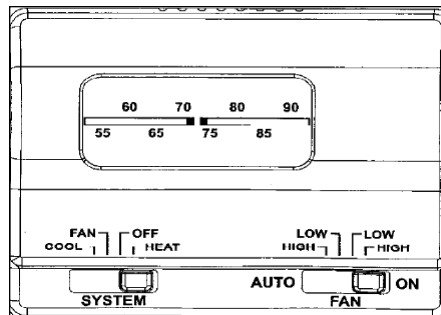

From the time you turn the thermostat on, there is a delay built into the furnace to perform a purge cycle preventing any possible propane vapor build up in the chamber.

NOTE: Different model furnaces are used for different unit floor plans. Each model furnace has its own Users Manual. The following instructions may vary slightly from the instructions in your unit.

Therefore very important that you refer to the Users Manual provided in your unit.

WARNING! If the user of this appliance fails to maintain it in the condition in which it was shipped from the factory or if the appliance is not used solely for its intended purpose or if appliance is not maintained in accordance with the instructions in this manual, then the risk of a fire and/or the production of carbon monoxide exists which can cause personal injury, property damage or loss of life.

OPERATING INSTRUCTIONS

	WARNING
DO NOT operate furnace while vehicle is in motion or being towed.	

Note; During initial firing of this furnace a burn-off of excess paint and oils remaining from manufacturing process may cause “smoking” for 5-10 minutes.

FOR YOUR SAFETY READ BEFORE OPERATING

	WARNING
If you do not follow these instructions exactly, a fire or explosion may result causing property damage, personal injury or loss of life.	

- A. This appliance does not have a pilot. It is equipped with an ignition device which automatically lights the burner. Do not light the burner by hand.
- B. BEFORE OPERATING smell all around the appliance area for gas. Be sure to smell next to the floor because some gas is heavier than air and will settle on the floor.

WHAT TO DO IF YOU SMALL PROPANE

- * Extinguish any open flame.
 - * Evacuate all persons from the vehicle.
 - * Shut off the gas supply at the propane container or source.
 - * Do not touch any electric switch or use any phone or radio in the vehicle.
 - * Do not start the vehicle's engine or electric generator.
 - * Contact the nearest gas supplier or qualified service technician for repairs.
 - * If you cannot reach a gas supplier or qualified service technician, contact the nearest fire department.
 - * Do not turn on the gas supply until the gas leak(s) has been repaired.
- C. Use only your hand to turn the handle on the manual shut off valve. Never use tools. If the handle will not turn by hand, don't try to repair it, call a qualified service technician. Force or attempted repair may result in a fire or explosion.
- D. Do not use this appliance if any part has been under water. Immediately call a qualified service technician to inspect the appliance and to replace any part of the control system and any gas control which has been under water.

Operating Instructions

1. Stop! Read Users Information Manual supplied with the furnace.
2. Set the thermostat to lowest setting.
3. Turn off all electric power to appliance.
4. The appliance is equipped with an ignition device which automatically lights the burner. DO NOT try to light the burner by hand.
5. Turn shut-off valve to "OFF". This furnace is equipped with a valve shut-off switch. With switch in "OFF" position, gas will not flow to burner nor will furnace operate.
6. Wait five (5) minutes to clear out any gas. Then smell for gas including near the floor. If you then smell gas, STOP, follow "B" in the safety information above on this label. If you don't smell gas, go to the next step.
7. Turn on all electric power to the appliance. These units are for use with LP gas only. LP gas is heavier than air. Therefore, to better clear out any gas, the heater should be operated for five

(5) minutes with the blower on and the gas off. If blower does not come on or stops before ignition cycle, go to shut down and contact your dealer or a local recreational vehicle service agency.

8. Turn shut-off valve to ON.
9. Set thermostat to desired setting.
10. If the appliance will not operate, follow the instructions "To Turn OFF Gas to Appliance" and call your service technician or gas supplier.

NOTE: If the furnace should lock-out, the blower will go off in 5 minutes and remain off until unit is reset by reactivating thermostat.

NOTE: These operating instructions will vary depending on the furnace size and model. Refer to the furnace manufacture information manual in your unit for the complete furnace operating instructions, for you unit.

TO TURN OFF PROPANE TO APPLIANCE

1. Set the thermostat to lowest setting, then move lever to "OFF" position.
2. Turn off all electric power to the appliance if service is to be performed.
3. Turn shut-off valve to "OFF". Do not force.

External Vents. Always be sure these vents are clear of any objects like screens, duct tape, etc.



WARNING

Do not install screens over the vents for any reason. Screens will become restricted and cause unsafe furnace operation. Accessories are being marketed for RV products which we do not recommend. For your safety, only factory authorized parts are to be used on your furnace.

Ducting. Wall or floor registers, and return air grills MUST be kept clear of any obstructions. Any such restrictions will prevent the furnace from correct operation. Closeable registers will reduce air flow. Never shut registers off completely, possibly causing furnace to limit out and shut down.

Gas pressure, as defined in Chapter Four - Systems, is extremely important. A dial gauge or U-tube manometer is required to perform tests and adjustments. Pressure must be set at 11 inches w.c. (water column) plus or minus 1/2 inch. Incorrect gas pressure can cause any appliance to operate inconsistently and cause poor combustion. Only qualified technicians with proper equipment should make any mechanical adjustments.

Voltage must be between 10.5 volts to 13.5 volts at the furnace during operation. Below 10.5 volts the furnace will shut down. Both high and low voltage places excessive wear on the motor and brushes.

Any mechanical adjustments, such as electrode adjustments, should be performed by a qualified service technician.

RANGE AND OVEN TOP BURNER OPERATION

The MXT and Rock Climber use the standard oven with three top burners. These appliances operate with propane gas only, never natural gas or methane.

	WARNING
DO NOT OPERATE THIS APPLIANCE UNLESS THE PRIVACY CURTAIN IS SECURE. FAILURE TO COMPLY COULD RESULT IN FIRE OR SERIOUS INJURY.	



WARNING

IF THE INFORMATION IN THIS MANUAL IS NOT FOLLOWED EXACTLY, A FIRE OR EXPLOSION MAY RESULT CAUSING PROPERTY DAMAGE, PERSONAL INJURY OR DEATH.

OPERATING INSTRUCTIONS

TOP BURNERS

1. Know which knob controls which burner. Always be sure all burners are turned off when the stove is not in use.

	WARNING
Be sure all control knobs are turned "OFF" when you are not cooking. Someone could be burned or a fire could start if a burner is accidentally left on or unattended even if only momentarily.	

2. Depress knob and turn fully counterclockwise to "LITE" position.
 - a. Verify sufficient propane supply before attempting to light the burner. Air in the propane line will significantly delay burner ignition. The burner may light unexpectedly as the air in the lines clears and is replaced with propane. This unexpected ignition could burn you. Air in the propane lines may occur

after the vehicle propane bottle and/or tank is refilled, during and after servicing other appliances on the same propane line, etc.

- b. Do not attempt to light more than one burner at a time.
- c. Immediately light the burner by holding a long match near the burner ports.

	WARNING
When holding the match or lighter to ignite flame, DO NOT position your fingers close to the burner. You could get burned causing injury.	

	CAUTION
Hand held igniters may be used but be sure they are the type designed for lighting open flame burners	

- 3. If any burner should extinguish after initial lighting or due to accidental blow out, turn propane off by turning control knob clockwise to “OFF”. Wait five minutes before attempting to relight the burner. Failure to follow these instructions could result in a fire or explosion.
If the burner should go out while cooking, or if there is an odor of propane, turn the control knob(s) clockwise to “OFF”. Wait five minutes for the propane odor to disappear. If the propane odor is still present – DO NOT relight the burners. See instructions in the appliance manual.
- 4. To turn the burner(s) off, turn the appropriate control knob clockwise to “OFF”.

	DANGER
ALL PILOT LIGHTS, APPLIANCES AND THEIR IGNITORS (SEE OPERATING INSTRUCTIONS) SHALL BE TURNED OFF BEFORE REFUELING OF MOTOR FUEL TANKS AND/OR LP-GAS CONTAINERS. FAILURE TO COMPLY COULD RESULT IN DEATH OR SERIOUS INJURY.	

Oven Burner

Note: Before the oven burner will operate, the oven pilot must be lit.

1. Lighting Oven Pilot
 - a. Be sure ALL valves are in the "OFF" position. The oven control knob should be in the "Off" position.
 - b. Be sure main propane supply is on.
 - c. Open the oven door; smell for propane. If you smell propane, STOP! Read and follow the instructions in your appliance manual.
 - d. If you do not smell propane, turn knob to the pilot position. "Push In/Lite Pilot"
 - e. Immediately light pilot with a match. Hold knob in at least 5 to 7 seconds, for this allows propane to flow to pilot and to heat the thermocouple. Release knob, pilot should stay on. NOTE; If the appliance has not been operated for a long period of time, a longer waiting period for ignition of the pilot may be due to the air in the pilot and propane lines. If pilot goes out, repeat, repeat steps a, b, c, d.
2. Operation of Oven Burner
 - a. Turn the oven control knob counter-clockwise to the desired setting. Oven burner will come on immediately and the oven burner will stay on until it reaches the desired setting. Then the oven burner flame will decrease in size. This is normal for this type of thermostat and this flame size will maintain a constant temperature within the oven. NOTE: Oven thermostat was calibrated at the factory and is not field adjustable.
 - b. For broiling, a 2-piece porcelain broiler pan can be purchased from Suburban:
 1. Center the broiler pan underneath the oven burner flame.
 2. Turn the food over frequently to ensure even browning.
3. To shut down the oven burner turn the oven control knob clockwise to "PILOT ON" position. At this position, the oven pilot will remain lit.
4. To shut down the oven pilot light, slightly depress knob and turn clockwise to "OFF" position. At this position, the oven pilot will go out.

WHAT TO DO IF YOU SMELL PROPANE

- * Do not try to light any appliance.
- * Do not touch any electrical switch.
- * Do not use any phone in your recreational vehicle.
- * Clear the recreational vehicle of all occupants.
- * Turn off the propane supply tank valve(s) or main propane supply.
- * Immediately call your propane supplier for instructions.
- * If you cannot reach your propane supplier, call the fire department.

Have the propane system checked and leakage source corrected by a qualified installer, service agency, manufacture or dealer or the propane supplier.

WATER HEATER



CAUTION

When the recreational vehicle is not in use or while traveling, it is recommended that the gas supply also be turned off.

SAFETY INFORMATION FOR YOUR SAFETY READ BEFORE OPERATING



WARNING

If the user of this appliance fails to maintain it in the condition in which it was shipped from the factory or if the appliance is not used solely for its intended purpose or if the appliance is not maintained in accordance with the instructions in this manual then the risk of a fire and/or the production of carbon monoxide exists which can cause personal injury, property damage or loss of life.



CAUTION

The thermostat on your water heater is not adjustable. It is a temperature sensing limit designed to maintain a water temperature of 130 degree F (54 degree C). Water temperatures over 130 degree F (54 degree C) can cause severe burns instantly or death from scalds; therefore, be careful when using hot water. Children, disabled and elderly are at highest risk of being scalded. Always feel water before bathing or showering.

SAFETY ITEMS



WARNING

It is imperative that the water heater tank be filled with water before operating the water heater. Operation of the water heater without water in the tank may result in damage to the tank and/or controls. This type of damage is not covered under warranty.



WARNING

If you do not follow these instructions exactly, a fire or explosion may result causing property damage, personal injury or loss of life.

OPERATING INSTRUCTIONS—GAS

- A. This appliance does not have a pilot. It is equipped with an ignition device which automatically lights the burner. Do not try to light the burner by hand.
- B. BEFORE LIGHTING smell all around the appliance area for propane. Be sure to smell next to the floor because some propane is heavier than air and will settle on the floor.

What To Do If You Smell Propane

- Do not try to light any appliance.
 - Do not touch any electric switch.
 - Do not use any phone in your recreational vehicle.
 - Immediately call your gas service center from your neighbor's phone. Follow the gas service centers instructions.
 - If you cannot reach your gas supplier, call the fire department.
- C. This is an automatic propane valve, no adjustments are necessary. Do not attempt to repair the propane valve. This may result in a fire or explosion.

- D. Do not use this appliance if any part has been under water. Immediately call a qualified service technician to inspect the appliance and to replace any part of the control system and any gas control which has been under water.
- E. Before operating water heater, check the location of the vent to make sure it will not be blocked by the opening of any door on the trailer. If it can be blocked, do not operate the water heater with the door open.

OPERATING INSTRUCTIONS FOR UNITS WITH DIRECT SPARK IGNITION GAS VALVE.

1. STOP! Read the safety information provided.
2. Turn off all electric power to the appliance.
3. Turn "OFF" propane supply.
4. Wait five minutes for propane to clear the area. If you smell propane, STOP! Follow instructions in item B of the safety information. If you do not smell propane, go to the next step.
5. Turn "ON" the propane supply.
6. Turn on electrical power to the appliance.
7. Turn switch marked "GAS" which is located on the bottom of the monitor panel, to "ON" position. If the burner does not light, the system will automatically attempt two more tries for ignition before lock out. NOTE: Each ignition cycle will have a fifteen second purge before spark cycle if the system is a three try system.
8. If lock-out occurs before main burner lights, turn switch to "OFF", wait five seconds and turn switch to "ON" position. This will restart the ignition cycle. The first start-up of the heater may require several ignition cycles before all air is purged from the propane lines.

If the burner will not come on, the following items should be checked before calling a service person.

1. Switch turned off.
2. Propane supply to heater is empty or turned off.
3. Reset button on ECO is tripped.
4. If burner fails to light, call a Suburban Service center or a local RV Service agency.

OPERATING INSTRUCTIONS—ELECTRIC ELEMENTS

Electric water heaters are designed to operate with a minimum amount of service problems, however, proper operation and care is essential.

By far the most common trouble with electric water heaters results from energizing the water heater before it is filled with water. Even brief operation of the electric element without water in the tank will burn out the electric heating element.

Before the electric element will operate, the switch located behind the water heater door in the lower left corner of the control housing must be in the "ON" position.

To energize the electric element, locate the switch, which is on the bottom of the monitor panel, inside the RV and turn the switch marked "ELECTRIC" to the "ON" position. The water heater temperature will be regulated by the thermostat.

To Turn Off Water Heater:

1. Turn switch to "OFF" position.
2. Turn off the electrical power to the appliance.
3. Turn off propane supply.
4. If the vehicle is to be stored or the heater is going to be turned off while subject to freezing temperature, drain the water heater.

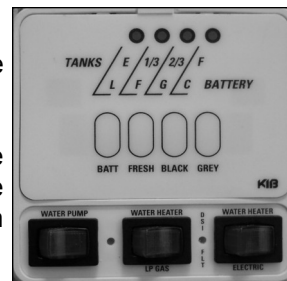

Winterizing Your Water Heater

If your water heater plumbing system is equipped with a bypass kit, use it to close off the water heater. Drain the water heater completely and leave the water heater closed off (out of the system) in the bypass position particularly if you are introducing antifreeze into the plumbing system. The by pass kit will have valves on the top and bottom, valve on bottom needs to be turned to divert water from entering water heater, and valve on top will keep water from flowing back into the water heater

Antifreeze can be very corrosive to the anode rod creating premature failure and leave sediment in the tank. If the plumbing system is not equipped with a bypass kit, and you intend to winterize by adding antifreeze to the system, remove the anode rod (storing it for the winter) and replace it with a 3/4 inch drain plug.

REFRIGERATOR

Performance of refrigerators depends on various factors, such as, energy, venting, leveling, humidity and atmospheric heat temperatures, but not limited to these. All refrigerators are designed with absorption type of cooling units requiring careful leveling and venting conditions.



Leveling

The refrigerator is made to operate within 3 degrees off level side-to-side and 6 degrees off level front-to-back (as looking at the front of the refrigerator). Operating it at more then these limits can cause damage to the cooling system and create a risk of personal injury or property damage. Make sure the vehicle is level before you operate the refrigerator.

Operation During Travel

While the refrigerator should be level when the vehicle is stopped, performance during travel is not usually effected.

Venting

For an absorption unit to operate fully it must have two vents. The lower vent serves as access to service components and allows air to enter. As the refrigerator heats up, warm air leaves through the upper vent in the roof or the upper side vent. The roof vent gives the best "chimney" results. However with correct baffles, side vent is good. All vents must prevent birds and rodents from entering.

Moisture Reduction Heater

The refrigerator has a heater that prevents moisture from forming on the center divider between the doors of the freezer and the fresh food compartment. The heater operates only when the refrigerator is ON.

Door Sealing

Check the seal of the door.

If either door does not seal correctly, excess frost will collect inside the refrigerator. Make sure the doors seal correctly.

- * Close each door on a piece of paper that is about the size and thickness of a dollar bill.
- * Gently pull the paper.
- * You should feel a slight drag between the gasket and the cabinet.
- * Do this on all four sides.
- * If you do not feel a slight drag on the paper, the door does not seal correctly.
- * Have your dealer or an authorized Norcold Service center correct the seal of the door.

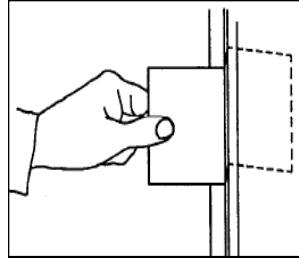

Door Handles

During travel, the door latch prevents the door from opening. When closing each door, push the door toward the refrigerator until you hear a “clicking sound”.

To open each door, pull the handle away from the refrigerator.



CAUTION

Do not use undue force or jerking action when opening the refrigerator door. Air temperature differences can cause a partial vacuum within the cabinet requiring a firm but steady force to open the door. A sudden jerk could cause door damage or personal injury.

Refrigerator Storage

Before the refrigerator is stored for an extended (seasonal) period of time:

Defrost and clean the interior of the refrigerator.

If the refrigerator is stored for an extended period of time, before startup:

Make sure there are no obstructions in the vents, the ventilation air pathway, the burner, the orifice, or the flue area.

For Defrosting and Cleaning the Refrigerator Interior, and other additional information and operating procedures, see the manual being supplied by the manufacture.

OPERATING THE REFRIGERATOR CONTROLS

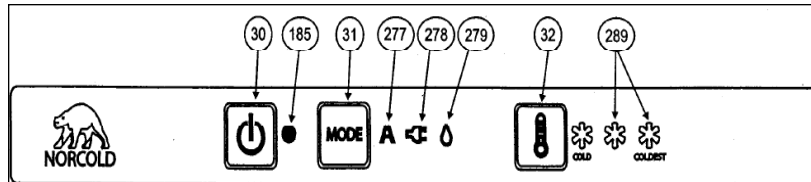

Control Panel

The refrigerator control panel is between the freezer compartment and the fresh food compartment. A 12 volt DC power supply is necessary for the control functions of the refrigerator to operate. The refrigerator receives DC power from the 12 volt system of the vehicle; either an auxiliary battery, a convertor, or the vehicle engine battery

For full operation details of all of the buttons and it's function on the control panel, refer to the Norcold refrigerator owners manual.

MONITOR PANEL

Your panel through modern technology will supply the charge condition of your battery and water level information from your water tanks.

Operation requires 12-volt DC power, supplied by the battery or converter. Sensors, one negative and three positive, attached to a resistor feed information to the display panel. To operate, place finger on button and push. A light will illuminate indicating the water level of tanks or charge condition of battery. "Galley" will light only when floor plan includes the second gray water holding tank.

The switch on the lower left corner of the monitor panel is for water pump operation. When in the "ON" position, pump will run until 40 to 45 PSI is achieved. The pump will shut off and restart at 20 pounds of pressure. Turn pump switch "OFF" when pump is not in use.

The red switch in the middle at the bottom of monitor panel is for the Water Heater LP gas. Red switch, lower right hand corner is for Water Heater electric.

When pushing the battery button, the highest light coming on indicates the battery condition: C-charging at 12.7 volts; G-good at 11.9 volts; F-fair at 11.2 volts; L-low at 6.0 volts. Press only one button at a time as one set of lights serves all functions.

