



GUIDEBOOK TO ENJOYMENT OF
YOUR KZRV
RECREATIONAL VEHICLE

***SPORTSMEN/
SPREE /SPREE CONNECT/
SPREE CONNECT LITE***

THE PURPOSE OF THE OWNER'S MANUAL IS TO PROVIDE THE MOST CURRENT INFORMATION AVAILABLE CONCERNING YOUR NEW RECREATIONAL VEHICLE ABOUT CARE AND USAGE.

ALSO MINOR MAINTENANCE AND CRITICAL SAFETY WARNINGS ARE INCLUDED AND **MUST** BE READ AND OBEYED.

ADDITIONAL MAINTENANCE INFORMATION IS FOUND IN " MAINTENANCE " MANUEL SUPPLIED WITH YOUR COACH. FAILURE TO PROVIDE CARE FOR YOUR R.V. COULD RESULT IN LOSS OF WARRANTY COVERAGE.

ADDITIONAL MANUALS MAY BE SUPPLIED AND AVAILABLE BY THE MANUFACTURER OF THE COMPONENT AND/OR APPLIANCE. SEE THE INFORMATION PACKET IN YOUR COACH.



Conventional Travel Trailer



Travel Trailer Toy Hauler



Fifth Wheel



Fifth Wheel Toy Hauler



Hybrid Travel Trailer

KZRV, L.P.
**“BUILDING QUALITY AND FUN
FOR OVER 40 YEARS”**

We congratulate you on your purchase of a KZRV, recreational vehicle. You have chosen a quality built RV which should provide you with many years of camping memories and fun.

The recreational vehicle you have purchased has been inspected by our trained inspectors and fully meets our high quality standards.

As the owner of a new KZRV, RV you can rest assured that we will do all we can to keep you a “happy camper”. Naturally, your selling dealership is always happy to help you with any questions you may have or service you may need. And should you need assistance when traveling, with over 250 KZRV, dealers nationwide, assistance is usually just minutes away.



KZRV
0985 N 900 W
Shipshewana, IN 46565

TABLE OF CONTENTS

Chapter 1 – Introduction to RV Ownership	1
Safety Considerations	2
Reporting Safety Defects.....	2
Safety When Emergency Stopping.....	3
Additional Safety Considerations.....	3
Extended or Cold Weather Use	4
Condensation	4
Causes.....	4
Solutions.....	5
Interior Ventilation.....	5
Chapter 2 – Service Procedures	7
Basic Service Procedures	7
Dealer.....	8
Factory.....	8
Parts.....	8
Owner’s Responsibility	8
Seasonal Site.....	9
Towable Limited Warranty.....	10
Chapter 3 – Using Your RV	13
Equipment.....	13
Tow Vehicle	13
Hitches – Travel Trailer.....	13
Hitches – Fifth Wheel.....	14
Hitch Height Specifications – Fifth Wheel.....	14
Hitch Height Specifications – Travel Trailer.....	15
Towing Level.....	15
Hook-Up (Travel Trailer)	15
The Safety Chain (Travel Trailer)	15
Hook-Up (Fifth Wheel).....	16
Front Landing Jacks.....	16
Traveling.....	17
Weights.....	17
Weighing Vehicle (Loaded or Unloaded).....	18
Loading the Trailer.....	18
Towing.....	20
Tires.....	20
Safety First-Basic Tire Maintenance	21
Understanding Tire Pressure and Load Limits.....	22
Tire Size	22
Tire Tread.....	22
Tire Balance and Wheel Alignment.....	23
Tire Repair.....	23

Tire Fundamentals	23
Tire Speed Rating.....	24
Vehicle Load Limits	24
Cargo Capacities	24
How Overloading Affects Your RV and Tires.....	25
How to Change a Tire.....	26
Wheel Bearings.....	26
Wheel Lugs.....	26
Brakes—Electrical	27
Breakaway Switch	28
Setting Up and Using Your Recreational Vehicle	29
Travel Trailer Un-Hook	29
Fifth Wheel Un-Hook	29
General Detector Information.....	31
Fire Extinguisher.....	31
Safety Detectors.....	31
Propane/ Carbon Monoxide Detector.....	31
What is Carbon Monoxide?.....	31
Dual Sensor Technology.....	32
Operation.....	32
Lower Power Option.....	33
Visual and Audible Alarm Signals.....	33
CO Alarm.....	33
Propane Gas Alarm.....	33
Malfunction Service Signal.....	33
End of Life Signal.....	34
Smoke Alarm.....	35
Operation.....	35
Testing.....	35
Steps-Two or Three	36
Windows	36
Doors.....	36
TV Antenna (Non Moving).....	37
Slide Outs	37
Power For Operation.....	38
Trailer Set-Up Requirements-General.....	38
Below Floor Slide System.....	39
Above Floor Slide Out (All Brands and Types.....	39
Bedroom Slide Out	39
Electrical Components.....	40
Manual Override.....	40
Below Floor Slide Out.....	40
Above Floor Slide Out.....	41
Bed Room Slide Out	41
Schwintec Wall Slide.....	41

Manual Override, Electric.....	42
Manually Push Room In or Out.....	42
Blinds.....	42
Ladder-Outside.....	43
Chapter 4 – Systems	44
Water and Drainage Plumbing.....	44
Fresh Water System.....	44
Tanks.....	44
Filling Fresh Water System	44
12-Volt Demand Pump	45
Faucets... ..	46
Bath and Shower	46
Outside Shower.....	47
Fresh Water Lines.....	48
Lo-Point Drains.....	48
Sanitizing and Filling the Potable Water System.....	48
Drainage (Fresh Water).....	49
To Drain System.....	49
Sanitation System	49
Toilets.....	49
Using Toilet and Tank System.....	50
Vents.....	51
Holding Tanks.....	51
Draining the Tanks.....	52
Flush System.....	53
Maintenance for Holding Tanks.....	53
Heated Holding Tanks.....	53
Winterizing Your Recreational Vehicle	54
By Pass Kit.....	55
Propane Fuel System.....	56
Propane Container.....	56
Servicing and Filling Propane Containers	57
Installing Propane Containers	59
Regulator.....	61
High Pressure Hoses with Acme Connectors	62
Main Supply Hose – Low Pressure	62
Operation.....	63
Checking for Leaks	64
Propane Gas Consumption	65
Electrical System.....	66
General Information.....	66
Changes and Modifications	66
120 Volt AC System.....	66
Power Cord 30 Amp or 50 Amp.....	66
Circuit Breakers and Box	67

50 Amp (Optional)	68
GFCI Protection.....	70
12 Volt DC System	70
Converter.....	71
Auxiliary Battery (Optional on Some Units).....	71
Circuit Breakers and Fuses-12Volt DC.....	72
Exterior Lights and Connector, 12V	73
Porch Lights.....	74
Brake Wiring.....	74
Chapter 5 – Appliances.....	75
Furnace.....	76
Thermostat (With Air Conditioner).....	76
Thermostat (With Out Conditioner).....	77
Operating Instructions.....	77
To Turn Appliances Off.....	78
External Vents.....	78
Ducting.....	78
Range and Oven Top Burner Operation	79
Drop-In Stove Without Piezo Ignition.....	79
Top Burners.....	79
Oven and Range Combination	80
Stove Top Ignition System	80
Oven Burner	81
Water Heater.....	83
DSI Models.....	83
Operating Instructions—Gas.....	83
Operating Instructions—DSI.....	83
Operating Instructions—Electric Element.....	84
To Turn Off Water Heater.....	84
Winterizing Your Water Heater.....	85
Refrigerator.....	85
Leveling.....	86
Venting.....	86
Battery Drain Information.....	87
Door Seal.....	87
Door Latch.....	87
Operation in Transit.....	87
Defrosting and Cleaning the Refrigerator Interior.....	88
Operation of Refrigerator.....	88
Operating the Refrigerator Controls.....	88
Monitor Panel.....	89
Outside Kitchen.....	90

CHAPTER 1 INTRODUCTION TO RV OWNERSHIP

Welcome to the growing family of new KZRV owners and the world of recreational vehicle travel. The purchase of your KZRV product allows you to enter this type of camping and leisure travel. Your coach has been designed and engineered to offer many comforts of home. KZ Recreational Vehicles are designed and constructed to be used as temporary living quarters for camping and travel uses. The coaches are not intended for hauling cargo.

This owner's manual was prepared to assist you in understanding the proper use and operation of various containment systems, servicing and maintenance of component parts, and explanation of your warranty protection. If this is your first RV travel coach, you will want to acquaint yourself with all aspects and information found in this manual plus manuals supplied by component manufacturers.

These materials will reflect the most current information available for the user. Some components and items may not be in your coach as they may be options on different models.

Keep this owner's manual in your recreational vehicle for handy reference. Get to know your new vehicle and how it operates. You should carefully read and understand these instructions, as well as information supplied by the manufacturers of separately warranted products, since they contain important operating, safety, and maintenance instructions. If you have questions that are not adequately answered by this manual or other booklets, consult your dealer. If he cannot satisfactorily answer your questions, he will call our staff for additional information.

Every effort has been made to provide you with a safe, dependable product. Your vehicle complies with applicable requirements of Federal Motor Vehicle Safety Standards, State Regulations, Canadian Standards Associations (CSA) where applicable, and complies with requirements of ANSI Standard 1192, the nationally recognized "Standard for Recreational Vehicles – Installation of Plumbing, Heating and Electrical Systems." The Recreational Vehicle Industry Association (RVIA) and Canadian Standards Association (CSA) periodically inspect our production lines and assist us in maintaining strict compliance with installation and safety standards for those systems. **Your follow-up with periodic safety inspections and a program of preventive maintenance is important for the continuation of safe and trouble-free operation.**

Camping is a great way to relax and enjoy the outdoors with your friends and family. Please remember to tread lightly on our beautiful land and leave only your footprints so that others may enjoy nature as much as you did.

SAFETY CONSIDERATIONS

The terms **NOTE, CAUTION, WARNING, AND DANGER** have specific meanings in this manual as well as component manuals.

A **NOTE** provides additional information to make a step or procedure easier or clearer. Disregarding a **NOTE** could cause inconvenience, but would not be likely to cause damage or personal injury.

A **CAUTION** emphasizes areas where equipment damage could result. Disregarding a **CAUTION** could cause permanent mechanical damage. However, personal injury is unlikely.

A **WARNING** is giving notice to user that potential injuries may occur to a person from equipment and mechanical failure. Disregarding a **WARNING** may result in serious physical injury to occupant.

A **DANGER** alerts areas where safety measures **MUST** be strictly adhered to, as such failures can be dangerous. Disregarding a **DANGER** could cause serious injury and possible loss of life.

Reporting Safety Defects

If you believe that your vehicle has a defect which could cause a crash or could cause injury or death, you should immediately inform the National Highway Traffic Safety Administration (NHTSA) in addition to notifying KZRV.

If NHTSA in addition receives similar complaints, it may open an investigation, and if it finds that a safety defect exists in a group of vehicles, it may order a recall and remedy campaign. However, NHTSA cannot become involved in individual problems between you, your dealer or KZRV.

To contact NHTSA, you may either call the Auto Safety Hotline toll-free at 1-800-424-9393 or write to:

NHTSA
US Department of Transportation
Washington, DC 20590

You can also obtain other information about motor vehicle safety from the Hotline.

Safety When Emergency Stopping

It is wise to carry road flags and/or triangular warning devices to be used when necessary. When pulling off a highway, use your four way hazard lights as warning flashers, even if only to change drivers. Pull off the roadway completely if at all possible to change flat tires or any emergency need.

Additional Safety Considerations

1. Sanitize the fresh water supply system periodically (see sanitizing instructions).
2. Keep water connection fittings from coming in contact with the ground or drain hose to reduce chance of contamination.
3. Enlist services of a Qualified RV Technician to fix gas or electrical appliances, or any other gas or electrical system problem.
4. Always have a serviceable fire extinguisher placed in an easily accessible location.
5. Insure that tires are in good condition and properly inflated. Watch tire inflation closely. Under-inflated tires will overheat. Overheated tires are a potential hazard as they may throw rubber and cause a blow-out. Check the tire pressure before each trip while the tires are cold.
6. Check and tighten the wheel lugs regularly (every 50 miles when new until 200 miles are reached and then check the lugs every 500 miles).
7. Check the brakes in a safe area – not while traveling on a busy highway.
8. Always block the trailer wheels solidly before unhitching.
9. Before leaving a camp area with a trailer in tow, insure:
 - a. The safety pin or locking lever is seated.
 - b. The breakaway wire is attached to the tow vehicle.
 - c. All jacks are raised so that they cannot touch the ground.
 - d. The 110-volt electrical cord is properly stored.

- e. The safety chains are connected.
 - f. All interior lights are off.
10. Observe and obey the warning labels attached to your vehicle concerning propane, water, electricity and loading.
 11. Extinguish all campfires before leaving your campsite.

EXTENDED OR COLD WEATHER USE

Your KZ recreational vehicle has been built for enjoyment in a recreational manner. This recreational vehicle is not intended to be used as full-time living quarters. Nor is this a four season unit. Using this unit in freezing conditions is not recommended. However, if unit is used in freezing weather, following are guidelines to follow. Any problems resulting from freezing are not covered under warranty.

1. For winter use in freezing conditions, more protection may be required. Use skirting and/or insulation below floor level to provide additional protection.
2. Remember, water freezes at 32° Fahrenheit whether fresh or drainage. Proper care must be used to protect any system at 32° F or lower. Local recreational vehicle dealers and campground personnel may be able to advise you on needed protection.
3. Energy requirements, such as propane and electrical supplies must be adequate. Protect your propane regulator from freeze-ups.
4. During cold weather you will experience more condensation than normal. Using ventilation or a dehumidifier may be needed.

CONDENSATION

Where it comes from, what causes it, and various solutions. Condensation is not a warranty issue.

Causes:

- A. It occurs when warm moist air contacts a cold surface, such as rain touching the window or roof vents with people breathing warm moist air against it from inside due to normal breathing.
- B. When cooking food or taking a shower, warm moist air circulates throughout the coach attaching itself to cooler surfaces, forming beads and running down wall or window

- C. Normal breathing will emit approximately 1/2 pint of moisture into the air per person, per day. The more occupants the greater quantity of condensation you may find.

Solutions:

1. When taking a shower, open bath roof vent approximately ½ inch allowing moisture to escape.
2. Use the power vent over range when cooking.
3. If condensation is found in cabinet or closets, open a cabinet door slightly to equalize temperature and provide ventilation.
4. Opening windows and roof vents, when possible, allowing warm moist air to escape is the best way to reduce condensation.
5. Under extreme conditions, you may need to use a dehumidifier to remove moist air conditions.

In camping, coaches which have tents or fabric bunk areas, it is even more important to avoid condensation drops from roof area.

Opening the tent window at the person's head will allow air to flow across the roof reducing or avoiding condensation.

Uncontrolled condensation can cause dampness, mildew, etc., inside your recreational vehicle. Be sure to make strong efforts to control condensation.



INTERIOR VENTILATION

A new coach always has a peculiar aroma, due to all the components used to build it, such as paneling, plywood, carpet and fabrics.

Allowing fresh air to move and circulate throughout a new recreational vehicle is very valuable for several reasons.

1. Components used to build RV'S always have a "new" smell to them, possibly irritating the respiratory system of the human body on warm days.
2. Fresh air is always good for the human body unless allergies are a factor.

Numerous ways are provided to exchange air in coaches.

1. Open windows on non-rainy days, allowing air exchange between inside and outside.
2. Power hood vent above cooking stove will send heat and food smell outside.
3. Roof vent; numerous types;
 - a. Standard air flow using gravity flow method.
 - b. Power (12v or 110v) vents will move air faster.
 - c. Hi-volume power vents, operation in 12 volt power can exchange air in a coach in several minutes if windows are open accordingly. If there is a fan in the rear, open window (s) in front.

Different brands/models have different features, such as remote control, rain sensor, variable speed control switch, etc.

Read carefully the operating instructions which are provided by the manufacture and can be found in your coach.

CHAPTER 2 SERVICE PROCEDURES

BASIC SERVICE PROCEDURES

KZRV and Your KZRV Dealer have a strong and dedicated interest in maintaining the highest quality customer relations with its owners. Your satisfaction with your KZ recreational vehicle and your KZRV dealer is our primary concern. In addition to producing high quality products, we want to assure our customers of our support with parts and service availability. **Our dealer network is the first choice to serve and supply your needs for your recreational vehicle.** Our authorized dealers will pleasantly assist in providing service maintenance needs plus parts, options, and information concerning your recreational vehicle.

Should you experience a problem with service availability, please follow the steps in the order listed below.

1. Contact your selling dealer's service department for an appointment. Describe to the best of your knowledge the nature of the problem. Please keep appointments to establish a good, workable relationship.
2. Contact the owner or general manager of the dealership should the initial attempt fail with the service department.
3. Contact:
Customer Relations Department
KZRV
0985N 900W
Shipshewana, IN 46565

Phone: (866) 472-5460
Hours: (8am-5pm E.S.T.)

E-mail: kz@kz-rv.com
Website: <http://www.kz-rv.com>

Give all the above information as requested along with the serial number of the coach in question. We will make every attempt to resolve your problem.

Please bear in mind that most problems arise from misunderstandings concerning warranty coverage and service. In most instances, you will be referred to the dealer level and your concerns will be resolved with the dealer's facilities and personnel.

Dealer

Your authorized KZRV dealer has performed a PDI (pre-delivery inspection) on your recreational vehicle. Since your dealer is authorized to sell KZRV products, they are also there to supply parts, optional equipment, and provide service repairs, warranty or otherwise as needed.

First choice for warranty repairs is your selling KZRV dealer. Other dealers can be used, however, prior approval is required.

Some recreational vehicle dealers may be authorized service centers for certain manufacturers of products warranted separately, such as appliances. Check with your dealer before contacting anyone else to reduce delays. If the dealer is not an authorized service center for the product in question, he can assist you in obtaining authorized service.

Factory

Service repairs can be performed at the manufacturing facility at Shipshewana, Indiana. Should your KZRV product be in need of major repairs and your dealer recommends factory repairs, please follow the steps listed below for such work.

1. Your dealer **must** make an appointment with service personnel at the factory PRIOR to your arrival.
2. Any freight costs, are the responsibility of the owner as listed in the warranty coverage schedule.

Parts

Stocking of parts varies from dealer to dealer. Any authorized dealer can order any required part to be shipped to their dealership. All parts are obtained through authorized KZRV dealers only.

Owner's Responsibility

When owning and using a recreational vehicle, it is important to perform regular and normal maintenance. This is recommended twice a year, spring and fall, to prevent undesired deterioration of your coach. Weather elements play an important function on sealants and other components requiring normal maintenance.

As an owner and operator, it is your responsibility and obligation to inspect and return your coach to an authorized dealer for repairs as required. Your authorized selling dealer is always your first choice and he certainly has continued interest in your satisfaction. As your manufacturer, we recommend that inspection and service be performed by your selling dealership.

If you are traveling and are unable to locate an authorized KZ dealer, or an authorized dealer for the component needing service, please call our customer service office at (866)472-5460. Service at a non-authorized dealer MUST have prior authorization. You may be asked to return any mechanical parts replaced before reimbursement consideration is made. Unauthorized or improper repairs may void the warranty of that component. Always keep your owner's manual along with a copy of your warranty registration with you when traveling.

Seasonal Site

When placing your unit on a camp site in the spring and returning it in the fall to your home, it's classed as a "seasonal site."

Performing repair work on such a site is not recommended for numerous reasons; available parts, tools, space, weather conditions, etc.

Any service repairs which require a service technician also requires the unit to be taken to a service facility, preferably your selling dealer.

Warranty coverage does not include trip or service call costs for such a trip. It is the owners responsibility to provide for such costs.

TOWABLE LIMITED WARRANTY

Two Year Limited Warranty

SUMMARY OF WARRANTY: KZRV warrants the structure of every towable recreational vehicle or truck camper purchased from an authorized KZRV dealer to the first retail consumer for a period of two (2) years, to be free from substantial defects in materials and workmanship when used for its intended purpose. The warranty period begins on the date of purchase or the date the unit is first placed in service, whichever is earlier. For purposes of this Towable Limited Warranty ["TLW"], the term "structure" includes the interior and exterior sidewalls, floor, roof, and frame.

EXCLUSIONS FROM WARRANTY: Excluded from coverage under the TLW are: (1) items added, changed, or modified after the unit left the possession of KZRV; (2) units used for any commercial purpose; (3) units used for full-time residential use or more than occasional recreational use; (4) wear and tear caused by normal usage by the consumer, including but not limited to fading or discoloration of soft goods [e.g., tents, upholstery, drapes, carpet, vinyl, screens, cushions, and mattresses], fading or discoloration of exterior or fiberglass components, tears, punctures, soiling, mildew, mold, and the effects of moisture condensation inside the unit; (5) the effects of alteration, tampering, mishandling, neglect, abuse, misuse, weather, acts of nature, acts of God, or corrosive atmospheres that promote rusting, oxidation, or pitting; (6) minor imperfections that do not interfere or affect the suitability of the unit for its intended use; (7) the effects of consumer's or transferee's failure to perform normal and routine maintenance [e.g., inspections, lubrication, adjustments, tightening of screws and bolts, tightening of lug nuts and wheels, sealing, rotating, cleaning, or other damages resulting from failing to follow the maintenance schedule and procedures in the owners manual; (8) damages resulting from misalignment or adjustments to axles or spindles caused by improper maintenance, modification, loading, unloading, road hazards, road defects, off road travel, or tire failures; (9) damages caused by the negligent or intentional use or misuse of the unit by the consumer or transferee, including but not limited to occurrences while towing the unit; (10) claims made for alignment or adjustment of patio doors [Note: any unit with a patio door is not intended to be towed like a travel trailer, and must be permanently parked on a lot. If such a unit is towed this TLW is voided in regard to the patio door and the surrounding structures]; (11) loss or damage caused by a person or business as a result of transporting the unit after sale to the consumer, delivering the unit, or parking the unit; (12) loss or damage to the plumbing system caused by freezing; (13) claims for personal injuries of any type; (14) costs of transportation of the unit for repairs; and (15) components that are warranted separately by another manufacturer [the warranty provided by a component manufacturer is the sole responsibility of that manufacturer, and KZRV does not warrant those components. Please refer to the warranties issued by the component manufacturers for the terms and conditions of such warranties].

TO OBTAIN WARRANTY SERVICE: Warranty service may be performed only at KZRV, or at KZRV authorized dealers and service centers. Contact KZRV for a list of authorized dealers and service centers. **REPAIRS OR REPLACEMENTS BY**

UNAUTHORIZED DEALERS OR SERVICE CENTERS WILL VOID THIS TLW. If the consumer believes that a claimed defect is covered by this TLW, contact must be made with an authorized dealer or service center WITHIN THE WARRANTY PERIOD. Sufficient information must be given to attempt to resolve the claimed problem. Should KZRV determine that repair or replacement is appropriate, the consumer must deliver the unit to the dealer or service center as directed. Delivery shall occur no later than thirty (30) days after the authorization for repair or replacement. Do not deliver your unit to KZRV, an authorized dealer, or service center without prior authorization. All costs incurred by the consumer for transportation for warranty service shall be the sole responsibility of the consumer. The dealer or service center shall repair or replace any warranted defect within a reasonable time, but no later than ninety (90) days after delivery by the consumer. Should the unit not be repaired or replaced within said period of time, then the consumer must contact KZRV by CERTIFIED MAIL with a written description of the claimed warranted defect and the efforts to remedy it. FAILURE TO SO NOTIFY KZRV IN THIS REGARD SHALL RENDER THIS TLW VOID AS TO THE CLAIMED DEFECT. After receipt of such notice, KZRV shall repair or replace such warranted defect within a reasonable time, but not later than ninety (90) days after delivery by the consumer. The scheduling of warranty work at an authorized dealer or service center is not controlled by KZRV and delays may be experienced. KZRV is not responsible for loss of use of the unit, expenses for fuel, telephone, food, lodging, travel, loss of income or revenue, or loss of or damage to personal property.

DISCLAIMER AND LIMITATIONS OF WARRANTIES: NEITHER KZRV NOR ITS DEALERS SHALL BE LIABLE FOR INCIDENTAL, CONSEQUENTIAL, INDIRECT, SPECIAL, OR PUNITIVE DAMAGES OF ANY KIND OR ANY OTHER FINANCIAL LOSS ARISING OUT OF OR IN CONNECTION WITH THE SALE OR USE OF THIS PRODUCT, WHETHER BASED IN CONTRACT, TORT, STRICT LIABILITY, EQUITY, OR ANY OTHER THEORY, EVEN IF KZRV HAS BEEN ADVISED OF THE POSSIBILITY OF SUCH DAMAGES. KZRV'S ENTIRE LIABILITY SHALL BE LIMITED TO REPAIR OR REPLACEMENT, AT KZRV'S SOLE OPTION.

THE UNITED NATIONS CONVENTION ON CONTRACTS FOR THE INTERNATIONAL SALE OF GOODS IS HEREBY EXCLUDED IN ITS ENTIRETY FROM APPLICATION TO THIS TLW.

THIS TLW, AND THE REMEDIES HEREUNDER, ARE EXCLUSIVE AND IN LIEU OF ALL OTHER WARRANTIES, EXPRESS OR IMPLIED, INCLUDING WARRANTIES OF MERCHANTABILITY, FITNESS FOR A PARTICULAR PURPOSE, CORRESPONDENCE WITH DESCRIPTION, AND NON-INFRINGEMENT, ALL OF WHICH ARE EXPRESSLY DISCLAIMED BY KZRV. THIS TLW GIVES YOU SPECIFIC LEGAL RIGHTS AND YOU MAY ALSO HAVE OTHER RIGHTS THAT VARY DEPENDING ON LOCAL LAW. SOME STATES LIMIT OR PROHIBIT LIMITATIONS OF WARRANTIES, SO THE ABOVE MAY NOT APPLY TO YOU. YOU SHOULD CONSULT A COMPETENT ATTORNEY FOR LEGAL ADVICE.

MISCELLANEOUS: No repair or replacement effected shall cause any extension or renewal of the warranty period. KZRV may make parts and/or design changes from time to time without notice and repairs or replacements may be made with new or different parts. KZRV reserves the right to make changes in the design or material of its products without incurring any obligation to incorporate such changes in any product previously manufactured. At KZRV's, sole option, any dispute concerning any warranted defect may be resolved through mediation or arbitration. This TLW shall be governed by the laws of the State of Indiana, and any legal action shall be brought only in the Circuit or Superior Court of LaGrange County, Indiana.

WARRANTY REGISTRATION AND CONTACT INFORMATION: The warranty registrations for component parts should be completed and delivered in accordance with the instructions contained therein. The TLW registration must be completed and returned to KZRV within fifteen (15) days of delivery of the unit to the consumer. Failure to do so can void this TLW or cause delays in obtaining benefits. The TLW registration, and all inquiries, must be directed to: KZRV, L.P., Warranty Department, 0985 N 900W, Shipshewana, Indiana 46565, Telephone: (260) 768-4016.

I HEREBY ACKNOWLEDGE THAT I HAVE RECEIVED, READ, AND UNDERSTAND THIS TOWABLE LIMITED WARRANTY, AND THAT I HAVE INSPECTED THE UNIT AND FIND IT IN THE CONDITION REPRESENTED.

Date: _____
Purchaser

CHAPTER 3 USING YOUR RV

In this chapter you will find three areas of useful information to assist you with correct **equipment**, **traveling**, and finally, actually **using your recreational vehicle**.

EQUIPMENT

Tow Vehicle

Begin your camping experiences by obtaining a tow vehicle which will adequately transport your recreational vehicle to and from your chosen destinations. Your most important measuring tool is the GVWR, Gross Vehicle Weight Rating, to cross match the capability of your selected tow vehicle.

Most auto and truck manufactures provide trailer towing guides for their products. Ask your local automotive dealer for a copy or call the factory's direct lines for information. Many tow vehicles, including mini-vans, have special towing package options available for small travel trailers. Tow vehicles with long wheel bases perform better than those with short wheel bases.

A second factor is GCWR, Gross Combined Weight Rating, which refers to the total weight of the tow vehicle and any vehicle in tow as a "combined" weight. This information, supplied by the tow vehicle manufacturer, is related to the capability of the tow vehicle.

The condition of the suspension in your tow vehicle is also an important factor. Make sure your tow vehicle is in good operating condition and follow the factory recommended maintenance guidelines.

Hitches – Travel Trailer

After obtaining your tow vehicle, it is very important to choose, and have installed, a correct hitch system with weight distributing bars to accommodate your coach if so required. This selection and installation should be done by a professional hitch service center, which may or may not be your selling dealer. Sway controls may be needed based on size and weight of coach, plus capability of your Tow Vehicle.

Weight distributing hitches apply leverage between the tow vehicle and trailer. This assists in equalizing the weight between vehicles, resulting in both vehicles traveling level. The condition of the tow vehicle's suspension system will affect the towing performance capability of your equipment.



CAUTION

Trailers with tandem axles need to travel as level as possible, avoiding different weights on each axle plus handling conditions.



CAUTION

Using an oversized or undersized hitch can cause damage to the frame of your travel trailer or tow vehicle.

Hitches – Fifth Wheel

The best type of hitch is one that is bolted thru the truck bed floor and has brackets to attach to main frame members on truck.

Before installing your hitch be aware of the clearance needed between the truck cab and center of hitch pin. This is very important on short bed trucks.

Gooseneck hitch adapter is not permitted, due to additional stress it places on the bulkhead frame. Should you desire a gooseneck adapter, it **MUST** be preordered with changes in the front end of frame, before coach is built. By installing your own after coach is built, will void warranty on the front end of your coach.

Hitch Height Specifications – Fifth Wheel

There is no recommended hitch height for fifth wheels. The pin box is adjustable at two inch intervals for variance in trucks and their suspension systems.

Hitch Height Specifications – Travel Trailer

Due to axle bars being either straight or drop bars, the ball height will vary. To find the correct height for the ball hitch, set your trailer on a flat surface in level position. Measure from the inside of the ball socket to the ground, approximately 18 to 22 inches as shown, for correct spacing. You may wish to add 1 to 2 inches to this amount to compensate for sag of suspension of the tow vehicles when hooked to tow vehicles.

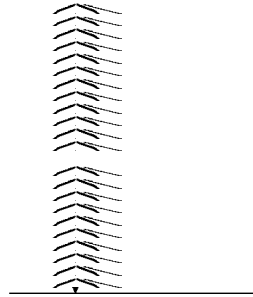

Towing Level

Towing any coach level, gives you the best travel performance, plus for every inch that the front end of coach portion is higher than rear axle, it transfers 100 pounds from front axle to the rear axle.

Hook-up for Travel Trailer

Hooking up your travel trailer is not difficult and gets easier with practice. The following procedure will help you until you become more experienced.

1. To raise the tongue of trailer above the hitch ball on hitch, turn the crank on the jack or operate with 12 volt DC power jack.
2. Open the coupler latch.
3. Back the tow vehicle into proper position.
4. Turn the crank on the jack to lower the coupler onto the ball hitch.
5. Close the coupler latch after completely seated.
6. Install weight distributing bars (equalizer), when required, as recommended by hitch supplier.
7. Retract the tongue jack to its maximum height.
8. Attach the cable for the breakaway switch to the tow vehicle.
9. Attach safety chains as per your state laws. See page 16.
10. Plug in your 12-volt, seven way electrical connector from the tow vehicle to the trailer connector

The Safety Chain (Travel Trailer)

Safety chain requirements will vary from state to state. The chain supplied with your coach meets SAE requirements for maximum gross trailer weight.

1. Cross the left chain under the coupler and attach chain to the right ring on the hitch receiver of tow vehicle.
2. Now take right chain under the coupler and attach to left ring on hitch receiver of tow vehicle.



CAUTION

Remember – always have the safety chain attached to tow vehicle, as required in your state.

HOOK-UP—FIFTH WHEEL

1. Place tow vehicle close to pin box.
2. Raise or lower front end of RV as needed.
3. Back your tow vehicle against pin carefully.
4. Lower pin box until it touches hitch.
5. Release latch to lock pin to hitch. BE SURE it is locked to avoid a drop on tow vehicle.
6. Raise front landing jacks and adjust feet so they clear any objects.
7. Plug in your 7-way electrical cord from the tow vehicle to the trailer connector.

FRONT LANDING JACKS

Front landing jacks on fifth wheel campers are available in two different types. Mechanical gear driven jacks are operated with a hand crank (manual) or optional 12 volt DC motor attached to gear box. Power is supplied by “on board” battery or by tow vehicle while attached with 7– way connector. A switch is mounted on front wall, spring loaded to raise or lower jacks. Don’t forget to block the wheels before you release the latch, raise pin box, and pull tow vehicle away. An in– line 30 amp fuse is located near the motor.

Now raise or lower front pin level your unit as needed.

TRAVELING

Weights

For safety reasons and federal regulations KZRV provides accurate weight specifications to owners. On the exterior left front corner of the coach you will find the Federal "Vehicle Identification Number" sticker, as required by the federal government. This tag supplies information concerning your coach, such as: VIN number, date/month of manufacture, tire size rating, plus information about weights as described on previous page and above.

Gross Axle Weight Rating (GAWR): is the value specified as the load carrying capacity of a single axle system, as measured at the tire-ground interfaces. One of five components will determine this rating: tires, axle, springs, brakes, or wheels. One of these five is generally rated slightly less than the others, which is used for the rating.

Gross Vehicle Weight Rating (GVWR): is the maximum permissible weight of this trailer when fully loaded. It includes all weight at the trailer axle(s) and tongue or pin on Fifth Wheel. This includes ALL cargo, options and liquids.

MANUFACTURED/FABRIQUE KZRV DATE
GVWR/PNBV ; SHIPSHE WANA,IN.
GAWR/PNBE;
WHEEL/JANTE;
COLD INFL./PRESS/ PRESS DE GCNFL.AFROID
THIS VEHICLE CONFORMS TO ALL APPLICABLE U.S. FEDERAL
MOTOR VEHICLE SAFETY STANDARDS IN EFFECT ON THE
DATE OF MANUFACTURE SHOWN ABOVE.

VIN/NIV NUMBER

Unloaded Vehicle Weight (UVW): is the weight of this trailer as manufactured at the factory and options ordered at the manufacturing time. It includes all weight at the trailer axle(s) and tongue or pin. If applicable, it also includes full generator fluids, including fuel, engine oil and coolants.

Cargo Carrying Capacity (CCC): is equal to the GVWR minus each

of the following: UVW, full fresh (potable) water weight (including water heater, and full propane weight.

Weighing Vehicle (Loaded or Unloaded)

The proper method to weigh the coach is to use a truck scale. Place the coach axles (tires) and tongue jack or landing jacks with front supports, 12" to 24" from the edge. Unhook the tow vehicle and move forward 6" to 8". Now record total weight. Re-hook the tow vehicle and remove the weight from the front support. Be sure no part of tow vehicle is on the scale. Now record the axle weight only. The difference between the two weights is the hitch weight.

KZRV suggests you also weigh each side (2 tires) separate to find balance of pounds per side. Its possible to have 1 side correct and the other side over-loaded. Often the slide out side or refrigerator side will be slightly heavier than the other.

The **second sticker** is about the weight of cargo placed in your coach. Location is on the inside of your coach, on the screen door, or inside of a cabinet door. It provides listed total allowable weight of cargo minus liquids allowed, water and propane.

RECREATION VEHICLE TRAILER CARGO
VIN—
The weight of cargo should never exceed
Kg.— Lbs.—
CAUTION
A load of water equals Kg. Lbs of cargo @ kg
Or lbs. per gallon

Loading your Trailer

Your recreational vehicle has been engineered to make maximum use of the available space for living and storage areas. The equipment and supplies you take along while traveling can be carried safely, provided the additional weight is distributed properly. Proper weight distribution within your trailer is an important factor in safety and efficiency of your trailer brakes, hitching, and how your tow vehicle will pull the trailer. DO NOT put excessive weight in the rear area. Excessive weight in the rear lightens the hitch weight, tends to magnify any sway from passing trucks or gusty winds, and reduce your control of coach when towing.

Lightweight and bulky items such as paper products, bedding, clothing, etc., should be stored in overhead cabinets and closets. Heavy items such as cooking utensils should be placed in lower cabinets. Canned goods need to be in a pantry, if so equipped, or in lower cabinets. Also, heavy items should be secured to avoid shifting during travel.

A reasonable principle in loading your coach is for every two pounds of weight loaded in front of the axle, one pound of weight must be loaded behind the axle. Also remember, improper side-to-side loading affects spring condition.

Uncalculated weight can and will effect your road performance.

Several floor plans have a rear storage section built into the trailer. Be very cautious how you load this area. Failure to abide by the weight limits can cause erratic performance while towing.

When using a weight distributing hitch and equalizer bars, you may move/transfer hitch weight from coach to tow vehicle assisting with level towing and easier travel.



CAUTION

Any damage caused by improper loading or installing additional equipment is NOT covered by KZRV Limited Warranty.



WARNING

The rear bumper on the frame will only carry 100lbs, therefore only the spare tire carrier, and spare tire can be added to the bumper. Do not add any other components to the bumper, such as bike racks, generators, cargo containers, and etc. Such items could cause fatigue and weld stress, which is not covered under warranty. Any such failures could damage your property and endanger vehicles following your camper during travel, which could result in an accident.

Towing

An available option to carry bicycles and other accessories on the rear bumper is a "Flip-up" rack for bicycles and other items secured to frame rack. Weight limit is 200 pounds with spare. It MUST be ordered before coach is built because 8 inches needs to be added to frame length at construction time. Cannot be added later.

When towing your trailer or fifth wheel you need to recognize the extra weight behind your vehicle. Below is a list of things which you need to remember while traveling.

1. With the trailer attached you will have slower acceleration and will require more distance to stop.
2. Be sure you have enough area at corners when turning, as wider turns are necessary. Be sure to use your turn signals for your own safety and the safety of others.
3. In passing or changing lanes remember you will need a longer distance to pass.
4. Use your rearview mirrors frequently to observe your trailer and traffic conditions.
5. When being passed by a large truck or bus, be prepared for displaced air as it may cause you to sway slightly, especially travel trailers.
6. When climbing steep, long grades and again while descending, use lower gears even before it seems necessary. Use your brakes smoothly and evenly.
7. Remember to drive more slowly on wet and icy highways to keep control of your vehicle.



TIRES

All KZRV towable coaches are equipped with appropriate rated tires for recreational vehicles. Tires are rated to carry weight as listed to G.V.W.R. Tires are radial in design using components to offer excellent strength and mileage in all kinds of weather conditions.

TIRE PNUE	SIZE DIMENSIONS	COLD TIRE PRESSURE PRESSIONDES PREUS A FROID
FRONT AVANT		
REAR ARRIERE		
SPARE DESESCOURS		

Tires on your vehicle(s) are one of the most important components of the towing package. Without inflated tires you will not be moving anywhere.

Taking care of your tires during travel is very important. Top of the list is maintaining correct air pressure and secondly is NOT overloading your RV.

With proper care, the performance of fuel economy and handling on the road will be better.

Safety on the road is very important in avoiding road hazards which can damage your tires plus obeying the speed limits.

On the left front, exterior corner of your coach, you will find the (VIN) Label along with a placard supplying information on tires such as tire size and amount of air pressure (maximum).

Both stickers are permanently attached to the trailer on the left front corner of exterior and easily readable from the outside of vehicle without moving any covers.

Due to weather elements, labels may fade over time. You may wish to record this information and keep it inside of coach, perhaps with owner's manual.

Safety First-Basic Tire Maintenance

Properly maintained tires improve the steering, stopping, traction, and load carrying capability of your vehicle. **Under inflated tires and overloaded vehicles are a major cause of tire failure.**

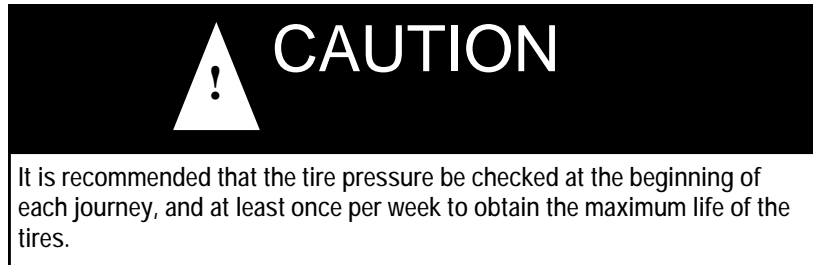

Understanding Tire Pressure and Load Limits

Tire inflation pressure is the level of air in the tire that provides it with load-carrying capacity and affects the overall performance of the vehicle. The tire inflation pressure is a number that indicates the amount of air pressure—measured in pounds per square inch (psi) - a tire requires to be properly inflated. (You will also find this number on the vehicle information placard expressed in kilopascals (kPa), which is the metric measure used internationally.)

The listed amount is for maximum load capacity. When traveling with less than full weight, you may wish to reduce air pressure for a smoother ride.

While driving, your tires will get warmer, causing air pressure to increase. To get an accurate pressure reading, you must allow tire's to cool down for three hours or more.

For your convenience, purchase a tire pressure gauge to keep in your RV. Gauges can be purchased at tire dealership's, auto supply stores and other retail stores.

Tire Size

To maintain tire safety, purchase new tires that are the same size as the vehicle's original tires or another size recommended by the manufacturer. Look at the tire information placards, or the sidewall of the tire you are replacing to find this information. If you have any doubt about the correct size to choose, consult with the tire dealer.

Tire Tread

The tire tread provides the gripping action and traction that prevent your vehicle from slipping or sliding, especially when the road is wet or icy. In general, tires are not safe and should be replaced when the tread is worn down to 1/16 of an inch. Tires have built-in tread wear indicators that let you know when it is time to replace your

tires. These indicators are raised sections spaced intermittently in the bottom of the tread grooves. When they appear “even” with the outside of the tread, it is time to replace your tires. Another method for checking tread depth is to place a penny in the tread with Lincoln’s head upside down and facing you. If you can see the top of Lincoln’s head, you are ready for new tires.

Tire Balance and Wheel Alignment

Tires are not balanced on your unit, nor is it required. You may choose to balance the tires on your unit, however this will not be covered under warranty.

Wheel alignments may be needed periodically due to road hazards, such as pot holes, etc. This also is not covered under warranty, due to being a uncontrollable element. Wheel alignments, will assist with getting the maximum life from your tires. Alignments require special equipment, and should be performed by a qualified technician.

Tire Repair

The proper repair of a punctured tire requires a plug for the hole and a patch for the area inside the tire that surrounds the puncture hole. Punctures through the tread can be repaired if they are not too large, but punctures to the sidewall should not be repaired. Tires must be removed from the rim to be properly inspected before being plugged and patched.

Tire Fundamentals

Federal law requires tire manufacturers to place standardized information on the sidewall of all tires. This information identifies and describes the fundamental characteristics of the tire and also provides a tire identification number for safety standard certification and in case of a recall.

Considerable quantity of information is built into the sidewall of tire, such as size, weight capacity, air pressure allowed serial number and where it was built.

The letters “ST” refer as “service trailer” tires used on most RV’S, manufactured for that purpose and not for automotive.

- **Maximum Load Rating**—This number indicates the maximum load in kilograms and pounds that can be carried by the tire.

■ **Maximum Permissible Inflation Pressure**—This number is the greatest amount of air pressure that should ever be placed in the tire under normal driving conditions

Tire Speed Rating

Each original tire installed on KZ RV recreational vehicle have a speed rating of 75 MPH or greater. Please note maximum load rating, tire pressure and speed rating as imprinted on the sidewall of tire.

Beginning in 2017 model year your tires will have nitrogen in them instead of air. The green caps on valve stems indicate contents are nitrogen.

Vehicle Load Limits

Determining the load limits of a vehicle includes more than understanding the load limits of the tires alone.

On a travel trailer and fifth wheel, there is a Federal certification label that is located on the left front of the sidewall on coach.

The certification label will include the vehicle's gross vehicle weight rating (GVWR), the most weight, when fully loaded, allowed on vehicle chassis. It will also provide the gross axle weight (GAWR), the most allowed per axle.

In the same location described is a placard showing tire and loading information including maximum cargo capacity.

CARGO CAPACTIES

Cargo can be added to the vehicle, up to the maximum weight specified on the placard. The combined weight of the cargo is provided as a single number. In any case, remember: the total weight of a fully loaded vehicle can not exceed the stated GVWR.

Water and propane also need to be considered. The weight of fully filled propane containers is considered part of the weight of the RV before it is loaded with cargo and is not considered part of the disposable cargo load. Water however is a cargo weight to be disposed. Remember water weighs 8 pounds per gallon. Reducing water quantity allows more cargo pounds. Understanding this

flexibility will allow you, the owner, to make choices that fit your travel and camping needs.

When loading your cargo, be sure it is distributed evenly to prevent overloading front to back and side to side. Heavy items should be placed low and as close to the axle positions as reasonable. Too many items on one side may overload a tire. The best way to know the actual weight of the vehicle is to weigh it at a public scale. Talk to your RV dealer to discuss the weighing methods needed to capture the various weights related to the RV. This would include weights for the following: axles, wheels, hitch or pin (in the case of a trailer) and total weight.

How Overloading Affects Your RV and Tires

The results of overloading can have serious consequences for passenger safety. Too much weight on your vehicle's suspension system can cause spring, shock absorber, or brake failure, handling or steering problems, irregular tire wear, tire failure or other damage. An overloaded vehicle is hard to drive and hard to stop. In cases of serious overloading, brakes can fail completely, particularly on steep hills. The load a tire will carry safely is a combination of the size of tire, its load range, and corresponding inflation pressure.

Excessive loads and/or under inflation cause tire overloading and, as a result, abnormal tire flexing occurs. This situation can generate an excessive amount of heat within the tire. Excessive heat will lead to tire failure.

It is the air pressure that enables a tire to support the load, so proper inflation is critical. Since RVs can be configured and loaded in many ways, air pressures must be determined from actual loads (determined by weighing) and taken from the load and inflation tables provided by the tire manufacturer. These air pressures may differ from those found on the certification label. However, they should never exceed the tire limitation for load or air pressure. If you discover that your tires cannot support the actual weights, the load will need to be lightened.

Note: Tires are warranted by the manufacturer of their respective brand and are to be serviced and warranted by a service center. Contact your dealer for information on service centers for tires.

How to Change a Tire

1. Place blocking under main rail of frame with hydraulic jack on top of blocking in front of front spring hanger, ALWAYS on main rail.
2. Break lug nuts loose before raising coach. DO NOT REMOVE lug nuts.
3. Raise coach with jack, until wheel is off the ground.
4. Place additional blocking under frame for security support. DO NOT depend fully on jack.
5. Be sure coach is solid and will not move with wheel and tire off.
6. Remove lug nuts when tire is off the ground.
7. Replace with spare tire and wheel onto hub.
8. Reinstall lug nuts and tighten firmly.
9. Drop tire and wheel onto ground after removing supports.
10. Now fully tighten and torque lug nuts at 90 to 120 pounds.
11. Place all equipment into coach or tow vehicle, blocking and jack.
12. Re-torque lug nuts after traveling 100 miles.

WHEEL BEARINGS

ALL wheel bearings are pre-lubricated during assembly of axle and brakes.

Your coach may have "ULTRA LUBE" method of having a grease fitting in the end of axle. Remove rubber cap on the end of axle and using a standard grease gun, you may place 6 to 8 shots of grease into the bearings, (if you forgot to repack bearings), before leaving on a trip. Don't forget to correctly repack bearings as per maintenance manual when you return home.

Wheel Lugs

When the wheels are installed on your recreational vehicle, the lug nuts must be tightened at 90-120 foot pounds of torque. Powder coat painted wheels may require more torque attempts due to thickness of paint. You must re-torque the wheel lugs at 50 and 200 miles. A decal on the wheel may require check torque earlier.

After your first trip, check the wheel lugs periodically for safety. The wheel lugs should then be checked after winter storage, before starting a trip or following extensive braking. The size of bolt head or nuts is 13/16 inch standard and 3/4" for chrome nut. **Over torque will damage components, especially if torque wheel lugs goes over 150 pounds. Normally the "nut" fails first however the embossing on the wheel can also be flattened, and then fail to keep wheel tight.**

Brakes – Electrical

Electric brakes on your recreational vehicle are designed to work in conjunction with the hydraulic brakes on your tow vehicle. This means to have the best brake performance on both systems, the trailer and the tow vehicle must perform and operate together. Any attempt to use either brake system alone, tow vehicle or trailer will cause accelerated wear and damage.

A brake control must be installed in your tow vehicle, mounted under dash to activate the electric brakes with 12-volt power either manually or by foot brake pedal. Electronic type is used most widely. Each brand has their own operating instructions.

Battery in the tow vehicle is the primary source of power to operate the brake system in towable trailer. Keep battery and charging system in good working condition to ensure available energy when required.

Wiring to operate your brakes must be sized in both vehicles, a minimum of 14 gauge is required. Your camper has 14 gauge from front end to brakes. Brake assemblies are wired in parallel, never in series. Being parallel, there will be equal voltage and amperage at each brake assembly for equal braking capability and/or performance. 12 gauge may be desired in your tow vehicle.

Use the foot pedal control for general operation on combined use of both brake systems. Manual control is to be used only in special situations, such as slow movement or icy road conditions. In open position, electrical current will flow to brake assemblies activating them.

Power from the battery is sent to the controller, the “switch” to provide the correct amount of current to brake assemblies on the coach. As you press harder on the brake pedal, more current will flow, applying brakes more, increasing braking capability.

When applying brakes to stop the trailer, begin pressing slowly to avoid quick and sudden stops, or possible “jack-knife” when wet or slippery. Use lower gear ranges to minimize the need of brakes during extended or steep downgrades.

WHEN YOUR COACH IS NEW IT WAS IMPOSSIBLE TO ADJUST THE BRAKE SHOES PRECISELY. WITH SELF-ADJUSTING BRAKE SYSTEM, THEY WILL SEAT THEMSELVES MUCH

SOONER THAN NON-SELF ADJUSTING SYSTEM.

This is why KZRV has chosen to place self-adjusting brakes on your coach.

Breakaway Switch

The breakaway switch is a safety part of your trailer's electric brake system. The very instant a breakaway occurs, the pull pin which is linked to the tow vehicle is pulled from the switch. The two contacts automatically close to complete the electrical circuit and apply the trailer brakes. This system will apply the brakes of the trailer should it become loose or detached from the tow vehicle. A 12-volt battery installed on the coach is required to power the breakaway switch.

Never use this breakaway switch and trailer brake system as a parking brake. There would be a high amp draw on battery and converter, potentially causing damaged wiring, connectors, and breakaway switch plus unnecessary energy draw.

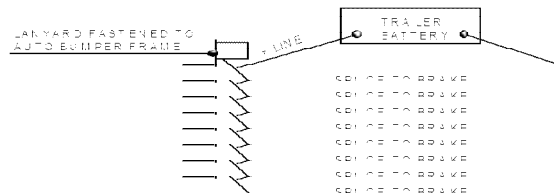

SAFETY BREAK-AWAY SWITCH WILL NOT OPERATE

Unless connected to a power source equivalent to or greater than an auto-motive type 12 volt, 12 amp hour wet-cell battery.

CAUTION; REMOVING PLUNGER WITH POWER TO BRAKES COULD RESULT IN DAMAGE TO BRAKES.

WARNING: Removing plunger while in storage could result in corrosion to unit points.

WARNING; A tag may be attached to lanyard cable; DO NOT use as a parking brake.

SETTING UP AND USING YOUR RECREATIONAL VEHICLE

We recommend that you select a level or nearly level place for camping. There are two reasons to be level. First, all components in your coach, such as your water drainage system and especially your refrigerator, are designed to operate in a level position. Second, it is more comfortable to live on the level. Should a level site not be available, use short 2 x 6 inch blocks of wood to raise the low side wheels to a level position.

Before unhooking the trailer from the tow vehicle, be sure the jack foot is in place on the tongue jack and block the trailer wheels to keep the trailer from moving.

Before lowering the tongue jack, you may wish to place a wood block or hard support under the foot of the jack, unless you are on a cement slab. This helps to prevent the jack from sinking into the dirt.

Before unhooking your tow vehicle, several safety items to remember.

- Be sure to park on solid ground.
- Be sure tires are blocked and unit cannot move.
- Be sure people and pets are away from camper.
- Be sure to park on level ground, if at all possible.
- DO NOT lift the coach up off the ground with stabilizer jacks

Travel Trailer Un-Hook

1. Release the weight distributing bars (if used).
2. Release the safety latch on the coupler.
3. Raise the latch on coupler on the A-frame by turning the tongue jack until the ball is free.
4. Disconnect the 7-way wire connector, safety chains, and the breakaway cable.
5. Raise front jack until coupler will clear coach. Move tow vehicle away.
6. Now raise/lower front end until coach is level.
7. Lower stabilizer jacks to desired position to stabilize coach.
8. Reverse procedure to hook up coach to tow vehicle.

Fifth Wheel Un-Hook

1. Extend lower leg extensions to solid support and insert pin fully.

2. Lower front jack extensions with “crank” or 12 volt D.C. power, placing some weight onto support.
3. Unlatch fifth wheel connection.
4. Disconnect 7-way connector and break-away cable.
5. Raise front jacks until tow vehicle will clear coach. Drive tow vehicle away.
6. Now raise / lower front end until coach is level.
7. Lower stabilizer jacks to desired position to stabilize coach.
8. Reverse procedure to hook up coach to tow vehicle.

The use of stabilizer jacks on a recreational vehicle is a popular and useful support. They provide a reasonable amount of stability while using, occupying, and moving around in your camper. It is important to remember that stabilizer jacks are for support of the coach and are not designed to bear or raise the weight of a recreational vehicle.

To operate the stabilizer jack, place crank onto the jack shaft and turn clockwise to lower until the frame begins to raise slightly. Equalize all four jacks for best support. You may need to adjust each jack two or three times.

To raise jack to upper travel position, insert crank and turn counterclockwise until jack is seated in UP travel position.

Upon completing the setup of your coach, you are now ready to make attachments to various facilities:

- ✓ Waste water hose connections.
- ✓ 110-Volt power cord electrical hookup.
- ✓ Turn on propane tanks and light pilot lights, if any, on appliances. Remember there may be air in your propane lines. Be sure to bleed them before planned usage.
- ✓ Open any windows and roof vents as desired for ventilation.
- ✓ Fresh water connections.

You may have additional accessories and options, such as an awning on the door side which needs to be opened. Separate instructions are provided by the manufacturer of these components.



CAUTION

When preparing to depart or move, don't forget to reverse the procedure above. Remember, open roof vents, windows, or TV antennas left in UP position are subject to wind damage in transit.

General Detector Information

As you are confined in a RV which is much smaller than a standard house, you must realize safety detectors will be activated much sooner than in a residential house, due to there being much less air volume

Each of these 3 detectors have their own manual and instructions, providing additional information for it's use and operation.

Life time of each detector is up to 10 years and needs to be replaced as per manufacture's instructions. Record purchase date on smoke alarm.

FIRE EXTINGUISHER

A fire extinguisher is installed in each vehicle and is located near the entrance door of recreational vehicle. Be familiar with it's location and operating instructions as printed on the extinguisher. Inspect your extinguisher at least two times per year or more as instructed on the extinguisher.

SAFETY DETECTORS

PROPANE/CARBON MONOXIDE DETECTOR

Any recreational vehicle which contains a propane fuel system with propane consuming appliances requires a propane leak detection device for safety protection. Currently this detector also serves as a carbon monoxide protection device. A converter or auxiliary battery is required to supply 12-volt DC energy to operate the device. There is no master cut-off switch to disengage detector.

WHAT IS CARBON MONOXIDE?

Carbon Monoxide (CO) is a highly poisonous gas which is released when fuels are burnt. It is invisible, has no smell and is therefore very difficult to detect with the human senses. Under normal conditions, in a room where fuel burning appliances are well maintained and correctly ventilated, the amount of carbon monoxide released into the room by appliances is not dangerous. These fuels include: wood, coal, charcoal, oil, natural gas, gasoline, kerosene, and propane. Such gases can build up in the blood, interfering with the body's ability to supply oxygen to itself.

Because CO is a colorless, odorless, tasteless, and highly poisonous gas that prevents the blood from carrying oxygen to vital organs, CO is 200 times more likely to replace oxygen in the blood. It can endanger lives even at low levels of concentration.

DUAL SENSOR TECHNOLOGY

The SAFE-T-ALERT 35 series combination CO/Propane Gas Alarm is an alarm that combines into a single, compact system a powerful alarm that detects both Carbon Monoxide (CO) and explosive gases propane (LPG) .

The 35 series uses the latest microprocessor technology combined with two electronic self-cleaning sensors that operate independently of each other. The combined unit can detect CO and explosive gases simultaneously.

Operation

When the unit is first powered up, the CO sensor requires a ten (10) minute initial warm-up period to clean the sensor element and achieve stabilization. The GREEN LED indicator will flash on and off during the 10 minute warm-up period. The unit cannot go into a CO alarm during the warm-up period. To test your unit during the warm-up period, press the test button. See Test Procedure in this manual. After the warm-up period, the GREEN power ON indicator should glow continuously. If the ON indicator light does not light, see the section, **Trouble-Shooting Guide**, in the user's manual for further information. **Do not attempt to fix it yourself.**

Gas Alarm: When you power the alarm, it has a warm-up period of approximately 1 minute. This unit cannot go into a gas alarm during the warm-up period. After 1 minute the alarm can detect explosive gas and will energize the relay on models 35-742-R and 35-742-R-MS.

Simultaneous CO and Gas Alarms– Because the risk of a propane gas explosion is generally a more serious danger, your alarm unit gives the gas alarm a higher priority during simultaneous alarm condition.

If your unit generates alarms for both Gas and CO at the same time, the gas LED will flash red and the beeper will sound. The CO LED will be a solid Red until the CO is ventilated out of the RV, at which time the LED will return to the Green operational/safe color.

Brownout Protection— The unit can tolerate short power interruptions and brownouts where the circuit voltage drops as low as 1 VDC. If the brownout lasts too long, the unit will reset and operate as described above.

LOW POWER OPERATION

This alarm will operate normally down to 7 VDC. Do not operate this alarm below 7 VDC.

VISUAL AND AUDIBLE ALARM SIGNALS

This SAFE-T-ALERT™ CO/Propane Gas Alarm is designed to be easy-to-operate. The alarm has two indicator lights that display a specific color for each monitored condition. There also is a matching sound pattern for alarm conditions.

CO ALARM

The Red CO LED will flash and the alarm will sound 4 “BEEPS” then be silent for 5 seconds. These signals indicates that the CO level is over 35 ppm. **IMMEDIATE ACTION IS REQUIRED.** See the **Procedures To Take During An Alarm in the user’s manual that is supplied with the detector.** This cycle will continue until the TEST/Mute button on the front of alarm is pressed. Ventilate the RV. The RED light will stay ON until the CO has cleared, or the alarm will reactivate in approximately 6 minutes if the CO is still present. DO NOT RE-ENTER THE RV. This alarm will return to normal operation after the RV’s properly ventilated.

PROPANE GAS ALARM

The RED LED will flash and the alarm will sound a steady tone whenever a dangerous level of propane or methane gas is detected. **IMMEDIATE ACTION IS REQUIRED.** See **Procedures To Take During A Gas Alarm.** The detector will continue to alarm until the Test/Mute switch on the front of the alarm is pressed. Ventilate the RV. The RED Gas LED will continue to flash until the gas has cleared, or the gas alarm will reactivate in approximately 5 minutes if the gas is still present. DO NOT RE-ENTER THE RV. This alarm will return to normal operation after the RV is properly ventilated.

MALFUNCTION/SERVICE SIGNAL. If any malfunction is detected, the Gas LED will remain off and the Operational/CO LED



WARNING!

LIMITATIONS OF CO AND GAS ALARMS THIS ALARM WILL NOT WORK WITHOUT POWER

Some reasons for no alarm power are; a blown or missing fuse; broken wire; a faulty wire connection or circuit breaker; a discharged battery; cut lead wires, or improper supply (+) or ground (-) connections.

will alternate Red/Green and the alarm will sound once every 15 seconds. Press the Test/Mute button. If the Test/Mute button does not clear signals, check the battery voltage. **If the battery voltage is not low and the unit will not return to normal operation, immediately remove the alarm and return for service or warranty replacement.**

<u>OPERATION</u>	<u>AUDIBLE SIGNAL</u>	<u>VISUAL SIGNAL</u>
NORMAL	NONE	STEADY GREEN
CO ALARM	4"BEEPS" 5 SECONDS OFF	STEADY RED
PROPANE ALARM	CONSTANT	FLASHING RED
ALARM	"BEEP" EVERY	ALTERNATING
MALFUNCTION	30 SECONDS	RED/GREEN
END OF LIFE	BEEP EVERY 30 SECONDS	RED/RED GREEN/GREEN FLASHING

End of Life Signal—5 year Service Life

All 35 series models include an End of Life (EOL) Signal indicating the sensor has reached the end of its service life and you **MUST** replace the alarm. The signal is the LED flashing RED RED GREEN GREEN with a beep every 25-30 seconds. The EOL Signal may be reset by pushing TEST/RESET button on the alarm. This will reset the EOL Signal for a period of 72 hours (3 days) for a total of up to 30 days. After 30 days the signal cannot be reset and the alarm **MUST** be replaced. **DO NOT DISCONNECT THE ALARM UNTIL YOU HAVE A REPLACEMENT ALARM AVAILABLE TO INSTALL.**

SMOKE ALARM

Smoke alarms are required when propane is in the coach and open flame cooking happens. Alarm is placed on the ceiling between the sleeping and cooking area of each RV built.

Energy to operate is supplied by a 9 volt battery.

Operation: The smoke alarm is in operation once the battery is correctly connected. The LED will flash every minute to show the battery is supplying power to the alarm. When production of combustion are sensed, the unit sounds a loud alarm which continues until the air is cleared.

TESTING

Test the alarm by pushing the test button on the smoke alarm cover for at least three seconds, until the alarm sounds. The alarm sounds if all electronic circuitry, horn and battery are working. If no alarm sounds, the unit has a defective battery or other failure and should be replaced immediately.

- Test each smoke alarm weekly to be sure it is installed correctly and operation properly.
- Test smoke alarms after the recreational vehicle has been in storage, before each trip, and at least once a week during use.
- Stand at arm's length from the smoke alarm when testing. The alarm horn is loud to alert you to an emergency. The alarm horn may be harmful to your hearing.
- The test button accurately tests all functions. Never use an open flame from a match or lighter to test this smoke alarm. You may ignite and set fire to the smoke alarm and your home.



WARNING

Test smoke alarm operation after vehicle has been in storage, before each trip, and at least once per week during use. Failure to comply may result in serious injury.

Steps (Two or Three)

Before entering your recreational vehicle place your hand in the center of the step assembly. Pull the step outwards. The step assembly will raise slightly and then out, away from the coach. The lower step will unfold 180° to useable position. The arm on the step will meet a positive stop. Step care, maintenance and lubrication will be found in the maintenance manual.



CAUTION

After lubrication, be sure no lubricant is remaining on step, causing a person to slip.

Windows

All windows are of slider opening design or solid picture window. Sliders may open horizontal or vertical as called for per floor plan. Egress windows have an unlocking handle or two small hinged clips on each side. After unlatching, the panel will swing out on a top hinge. On some egress windows, screens are attached to the swing out panel of window.

ALWAYS be sure egress windows are latched before traveling. If left unlatched, it may be destroyed during travel.

Doors

Locks on entrance doors have two lock mechanisms, a deadbolt in the frame section of lock and a standard lock in the handle. Both locks use the same key.

Screen doors may have two types of latches. First, a "roller" latch and secondly, a "hook" latch which needs to be tripped to open.

Locks on trunk doors need a small quantity of silicone lubricant sprayed internally two times per year to keep functioning correctly.

Optional door may have friction hinge meaning it must be pushed fully and cannot be swung freely.

T.V. ANTENNA—NON MOVING-Rigid

A new brand of TV Antenna is being installed on many of current production units. It has a rigid base to mount receiver head which cannot be rotated or raised up.

Base is attached to roof with 4 screws and antenna is attached with 2 bolts and nuts.

Inside of coach, on the wall, is a power supply with brown cover where you hook-up to TV and/or satellite. There is an on/off button on the power supply to engage the booster, located inside of the antenna head.

The antenna also serves as a radio receiver for the sound system in the coach.

Location of power supply is:

1. On the wall, above space for TV, free standing or wall mounted.
2. Behind the TV.
3. Possibly on the ceiling close to TV location.

	<h2>CAUTION</h2>
<p>The power supply should be turned OFF when connecting/disconnecting cables to power supply and antenna, but should be turned ON when testing for voltage.</p>	

SLIDE-OUTS

With many models of trailers, KZRV builds numerous slide out systems as listed below, followed by descriptions. Several different vendors supply components, loose and/or attached to frames.

1. Below floor system. All metal components are external, located under floor and in frame and inside of enclosed underbelly cover.
2. Above floor system. All components are inside and above floor, to be found under dinette of sofa slide out.
3. Bed room and closet slide-out system. May be above floor or below slide systems, same as above.

Before operating the power slide-out system in your coach, read and become familiar with these instructions, along with components and operation methods. Most of these components are inside of the enclosed underbelly cover and can't be seen.

POWER FOR OPERATION

All power slide systems operate on 12 volt DC power provided by a fully charged auxiliary battery, optional on most models, and a converter. Thru a 12 volt distribution load center, breakers are provided for each slide. For best performance, have 120 volt AC power attached to your coach, feeding the distribution load center. Tow vehicle 12V power may also be used as required.

A automatic reset breaker is located in the distribution box feeding the operation switch to the motor. Breaker size is 30 amp.

Supplement your battery by either one of two choices:

1. Hook up a 120-volt AC power cord to recreational vehicle for converter operation.
2. Use 12 - volt power through the tow vehicle to the recreational vehicle battery or batteries.

Either of these methods will help ensure maximum electrical power for the slide-out motor, as well as maintain your battery.

	<h1>CAUTION</h1>
<p>Because operating the slide-out draws up to 15 amp current from the battery, some source of supplemental charging should be operating while extending or retracting the slide out</p>	

TRAILER SET-UP REQUIREMENTS - GENERAL

Note:

1. Before operating the slide-out room, level the trailer front-to-rear and side to side.
2. Extend all stabilizer jacks to make solid contact with the ground and/or on solid blocks. Placing stabilizer jacks onto a hard surface allows the coach to remain square and assure a good weather tight seal between the room and trailer sidewall.

BELOW FLOOR SLIDE SYSTEM

Mechanical Components.

Below floor slide-out mechanism consists of a track welded to a frame cross member, matching with a gear on drive shaft assembly. Motor and gear box are mounted on a ram attached to bracket, to move room in or out. Operation is identical on both systems. As motor turns, a ram moves the gear on the track. A cross shaft, front to rear ram connects the second ram, moving the opposite end of slide. Mechanism operates the same, flush or standard floor.

ABOVE FLOOR SLIDE-OUT (ALL BRANDS AND TYPES)

This system operates on an inside ram assembly on a track moved by a cog gear. Ram is attached to the floor and side wall with a moving track attached to the slide-out. On larger slides, two (2) rams will be used with cross shaft connecting the 2 rams. A steel frame carriage style is used on some models, doing same function generally as a 12' slide. Access to these components is inside of coach, under slide floor.

BEDROOM SLIDE OUT

This slide assembly is placed and is attached to the floor of the front bedroom slide. This includes all hardware, motor gears, shaft, track and framework. Two rollers are also attached to sidewall at opening point, to give ease in slide out movement, in and out.

Operational Switch, Three Position Switch

OPEN : Hold operation switch in OUT position until room seals tightly on the exterior of the unit. DO NOT distort or bend the exterior flanges or interior fascia by holding the switch in the "ON" position.



CLOSE : To retract, reverse the procedure and hold button in the IN position until the room is fully inside with gaskets sealing to the outer wall. It takes about 20 seconds to move the slide in or out.

KZRV does NOT require or suggest blocking, supports, jacks, etc., to be used under slide outs during extended normal use. Should you place blocking under slide, you may distort water seal on sides and top.



CAUTION

When opening slide room, DO NOT over-extend. Fascia board can be distorted, loosened or bent from correct position



WARNING

Stand clear of the room's interior path and verify that the room's exterior path is clear before extending or retracting the room.

Electrical Components

A 12 volt DC motor is located between frame main rails along with gear box, attached to ram. On the above floor slide, it will be under the floor of the sofa or dinette.



WARNING

- ◆ Always make sure that the trailer is level before operating the slide-out room.
- ◆ Always make sure there are no obstructions blocking the path of the room when it is moving.
- ◆ Always make sure that the room path is clear of people and objects before operating.
- ◆ Always keep away from the slide rails under the coach when the room is in motion.

FAILURE TO FOLLOW THESE INSTRUCTIONS COULD RESULT IN SERIOUS INJURY OR DEATH.

MANUAL OVERRIDE:

BELOW FLOOR SLIDE-OUT

Should a power failure occur (no 120 volt AC power or the battery loses its charge), follow the directions listed below:

1. On Lippert rack and pinion frames, there is a 1/2" shaft coming through the main rail of frame. On the outer end is a small, 1/8"x1 1/2" pin that goes through the shaft. Use an adapter, plus socket, and ratchet to move slide in or out. Some use 3/4" nut welded to shaft rather than pin.

2. On DVS there is a 1/2" shaft coming through the frame rail. On the end is a 3/4" nut attached to the shaft. Use a 3/4" socket, extension, and ratchet to move the slide.

ABOVE FLOOR SLIDE-OUT

Manual Override (Single or Double Rams)

Should 12 volt power fail and there is no 120 volt AC power available, follow the directions listed.

Access to the ram is under the floor of slide, sofa or dinette, and is from the front. Lippert Component System has a smaller motor, less draw and requires a 5/8" socket, ratchet, and probably an extension shaft.

BED ROOM SLIDE-OUT

Access to move slide when no power is available is under the bed.

1. Remove any and all cargo under bed.
2. Pull up plywood panel covering mechanism.
3. Find shaft on front side of gear box. Use 3/4" socket and ratchet to turn shaft in direction you wish to move slide.

SCHWINTEC WALL SLIDE

System is composed of four tracks placed on the outer sidewall of slide, two at the bottom and two near roof line. On each side an extrusion is attached to sidewall with a motor inside at the top of extrusion, accessible only from inside. A gear mounted to the motor will run on the upper track to move slide in or out. Wire harness is along side of extrusion.

Power is supplied by 12 volt DC, convertor and/or auxiliary battery through a module board, located under the slide or near the slide in a cabinet.

Operation error codes are listed and found in the manual supplied by manufacturer of equipment for circuit board and other components.

It is very important to keep tracks clean from dirt and debris.

Don't forget, each side has it's own motor . Should slide move at an angle, one motor may be disconnected or failed to move.

MANUAL OVERRIDE

A. MANUAL OVER RIDE, ELECTRIC

1. Locate the circuit board.
2. Press the “ mode button six times quickly, press a 7th time and hold for approximately 5 seconds. The red and green LED lights will begin to flash, confirming the override mode.
3. Release mode button.
4. Back inside coach, use the normal control switch to retract the room.

B. MANUALLY PUSH ROOM IN OR OUT

1. Unplug both motors from circuit board. This releases the motor brake.
2. Push or pull slide room in as desired. Larger rooms may require several persons to move slide Keep both sides even.
3. When room is completely in, plug both motors back into the circuit board to apply brake for road travel.
4. Room must be travel locked during travel.

BLINDS

Any blinds with loose cords, such as mini-blinds **CANNOT** be installed in bunks designed and built for young children. Night shades, installed, have cords anchored to lower part of window and need to be secured for operation. KZRV recommends these shades be in the UP position for travel to avoid lower metal holder being in contact with garnish on window.

CAUTION : While traveling, all mini blinds need to be in the “up” position to avoid swinging and scratching paneling. Even with brackets at lower part of window, pull blinds up before traveling.

Loose furniture, such as dinettes and free standing chairs, need to be secured to prevent movement, contacting walls and causing wall and chair damage during travel



WARNING

These individual tassel cords reduce the strangulation hazard in the pull cord by removing the loop.

Do not tie cords together. Check periodically to make sure the cords have not twisted into a loop.

This device will not prevent strangulation hazard if young children wrap pull cords around their necks. Always keep cords out of the reach of young children.

Ladder, Exterior

Exterior ladder is provided as an option on most units to climb onto the roof area. Ladders are rated to handle 200lbs. at a time when climbing onto the roof. Some ladders have a folding step. Do not store articles on the ladder during travel. If you do so, warranty will become void on ladder.

CHAPTER 4 SYSTEMS

WATER AND DRAINAGE PLUMBING

Your KZ recreational vehicle has a complete water system, to carry fresh water, as well as holding tanks for used water. Each group has its own explanation along with its own operation.

FRESH WATER SYSTEM

Tanks

Water containers are installed in most RV's to carry water when direct city water is not available, such as "boon dock" camping. These tanks are located under floor, between main frame rails and steel bars to support them, on the bottom side.

All water containers have 3 exits lines, (1) to draw water from tank to fill lines. (2) external spigot to drain tank, (3) over flow line —B-2 below.

Filling Fresh Water System

To place water in to your coach's fresh water system, use one of the following methods. Different fresh water entry's are used depending on model and floor plan.

A. City Water Fill See Figure 1

1. Water is received into the system through a direct hookup, referred to as "city water fill". Attach a hose to the hook up and supply line. Open the faucet from the supply line. Enter the unit, and open any faucet, to allow air to escape, as there will be some air pockets.

Figure 1



B. Gravity Water Fill See Figure 2

1. To place water into the fresh water tank, remove cap from fill. Insert the garden hose into 1-1/4 inch flex tube 4 to 6 inches. Open the water supply faucet.
2. On gravity water fill, you will find a small screen, 1/2 inch at the 10:00 o'clock position, which is the vent and over flow line from tank. When water squirts out of this screen, stop filling tank immediately. Over flow line is much smaller than fill line. Plastic tank will not accept pressure.

Figure 2





CAUTION

DO NOT leave tank unattended while filling, as an over filled tank will built pressure, causing tank to crack, rupture, and leak or even damaging supports holding it in place.

C. During the water tank filling process, check the monitor panel for filling process. (if applicable).

S=Siphon hose– used to:

1. Winterize water system.
2. Sanitize water line system.

P=Pump 12 volt DC – To supply coach with water when city water is not available.

F=Filter-Cap to be removed to clean out or replace.

G=Gravity water fill-To fill tank.

C=City water fill-To fill lines.

T=Tank –To hold water.

V1= Valve to be opened ONLY when using siphon hose as listed above.

V2= Valve to be open to draw water from supply tank, closed when siphon hose is used.

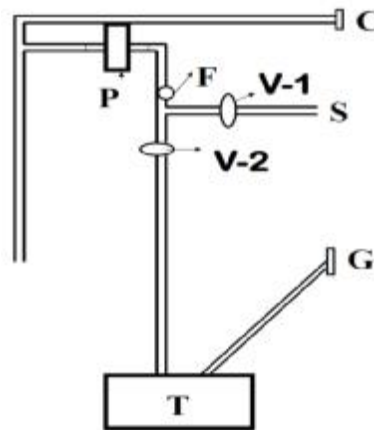

12-Volt Demand Pump

When water is desired and you are not hooked up to city water, your tank will be your supply. On your monitor panel is a switch to turn on the 12-volt demand pump. Energy for the pump is supplied by the auxiliary battery or converter. The pump will self-prime when started, supply water, and continue to run until approximately 40 pounds of pressure is achieved. When pressure drops to 20 pounds, pump will restart. Some cycling in pump may occur. A check valve is built within the pump to prevent water from flowing into the supply tank.

The pump has a small filter attached on the “in port “ side to prevent any foreign matter from entering the pump. You need to annually, or

even more often, remove the lower cup and clean it out or replace filter.

When pump is not in use, turn 12-volt power off at the switch.



CAUTION

Excessive pressure from water supply systems may be encountered in some parks, especially in mountain regions. Water pressure regulators are available to protect your system against such high pressure. A regulator at 45 pound rating is recommended to prevent damage to the plumbing system or components.

Occasionally your water pump may start/stop quickly (within a second). This is referred to as “cycling”. The cause for this annoying noise may be a slightly open faucet, water saver washer in the end of the faucet spout, plus other restrictive issues. If pump cycles every 10 to 15 minutes, there may be a slight water leak somewhere, check valve in city water fill, plumbing fittings or pressure valve in pump.

A cover may have been placed in your coach for cover around water pump to protect pump and it’s components, but not a code requirement. To gain access to this area requires removal of 2 to 4 screws holding the cover, against walls.

Faucet

The basic operation of a faucet is the same as in your home. Open the knobs or raise the single lever. Close faucets when sufficient water volume is achieved. It is normal to experience occasional air pockets in the system.



Bath and Shower

Your bathtub and shower are built with Vinyl, ABS, or fiberglass material, similar to those in your home. Shower curtains are provided with the coach and must be used to prevent water from spilling onto the floor, possibly causing damage.

The shower head used in the bathroom has a non-positive shutoff valve and will drip slightly in shut-off position. A vacuum breaker is also built into the faucet to permit water in hose to drain out as a code requirement to avoid contamination.



Before beginning your shower be sure the water heater is lit. Adjust the faucet for temperature before entering the tub or shower. When shower is completed, be sure to turn water off at the faucet.

Used water will drain through the plumbing pipes into the gray water holding tank. Remember capacities of your water heater and gray water holding tank. Long showers in a recreational vehicle are NOT suggested due to the amount of water that is available. To conserve water, wet down, and turn water off while you soap up, then rinse.

Outside Shower

A convenient faucet assembly with hot and cold water is available on most units for exterior use of washing or rinsing on the outside of camper, such as hands and utensils.

Two (2) methods are available—(a) Outside shower as shown. (b) Outside kitchen may have faucet with coil hose and spray nozzle to be attached as needed.

(a)

1. Open the door with key or thumb latch. Allow door to swing down or sideways.
2. Remove the shower head.
3. Open the faucet valves and adjust to the desired temperature.
4. To end operation close valve (s) on the faucet and allow water to drain from the shower head.
5. Close the valve on the shower head.



(b)

1. Attach coil hose to faucet Quick connect with spray nozzle.
2. Open faucet valves and adjust to desired temperature.
3. To end water usage, close faucet valves and disconnect coil hose.

DO NOT forget to drain hose and faucet for cold winter weather.

Fresh Water Lines

Two lines, generally red for hot and blue for cold, transport water through out the coach. Valves to direct flow are near city water fill or pump area. Connector elbows and tees are plastic or copper, and are held together with compression rings for no leakage.

Low-Point Drains

Low-Point drains are placed on recreational vehicles to drain water lines, tanks, and water heater to prepare coach for winterization and sanitizing systems. Drain may be black cap or valve.

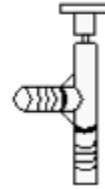

Fresh water supply tanks will have their own separate drains under the floor and/or frame, with a valve to be opened to drain.

Plumbing lines also have Low-Point drains located in various areas. You may find them (2) for hot and cold coming out of storage areas, outer metal skirt, through under belly covers, control centers, etc. Water should always drain out to the ground, not into underbelly cover.

	<h1>WARNING</h1>
<p>POTABLE WATER ONLY. SANITIZE, FLUSH AND DRAIN BEFORE USING. SEE INSTRUCTION MANUAL. FAILURE TO COMPLY COULD RESULT IN DEATH OR SERIOUS INJURY.</p>	

Sanitizing and Filling the Potable Water System

For your safety, you should sanitize your potable water system when your recreational vehicle is new or when it has been sitting unused for a period of time such as winter time, and it may have become contaminated.

Prepare a chlorine solution using 1/4 cup of bleach (5% sodium hypochlorite solution) to one gallon of water. Prepare one gallon of this solution for each 15 gallon capacity of the tank. As designed and constructed, this method will sanitize the plumbing system.

1. Close all the drains, tank, water heater, and low point.
2. Place prepared sanitizing contents into supply tank.
3. Open faucets and start pump.
4. Turn pump on and allow to run until liquid comes thru faucets.
5. Close faucets when air ceases to come out.
6. Allow liquid to remain in system for 3 hours.
7. Drain and flush with fresh water.
8. To remove any excess chlorine taste or odor, prepare a solution of 1 quart vinegar to 5 gallons of water and allow this solution to agitate in tank for several days by vehicle motion.
9. Drain tank again and flush with fresh water.
10. Your water system is now ready to use.
11. Turn pump power off when not using it.

The slide outs containing kitchens, will have flexible hoses installed on both fresh water lines and drain lines. Make sure there are no obstructions to allow free flow, and prevent any leakage or correct drainage.

Drainage (Fresh Water)

All permanent fresh water tanks can be drained. Two types of drains are used, (1) a push/pull, (2) a turn valve with open/close position or black cap.

To drain the supply lines and the entire system, you need to follow the steps listed below. Locate the valve placed at the floor level or close to the floor, found under the dinette, storage cabinet, and sofa. These valves will be at the "lowest" point of the water lines.

To Drain System:

1. Open all faucets including optional exterior shower.
2. Open the fresh water tank drain.
3. Open the water heater drain.
4. Open all (two to four) low-point drains.
5. Open the toilet valve, hold or block if need be.
6. To empty the pump, start and allow to run up to 20 seconds.

Sanitation System

Toilets

Two types or models of toilets are used on KZ recreational vehicles. One is the *Style II* model featuring a foot pedal for flushing. The

second type is referred to as the *Aqua Magic V*. This toilet is available with one lever for flush operation or with foot flush operation.



Prior to using your toilet, be sure to add a 4 oz. of deodorant chemical into the toilet with water. Flush contents into tank plus two or three gallons of water.

After each flush, about two inches of water will be in bowl, which is fine for travel. For best operating function, keep four to six inches of water in the bowl. This assists flushing procedure. Always flush for ten seconds or more to ensure all solids and wastes move into tank and are not held in drainage pipes.

OPERATION: Note the following photos showing movement of pedal down toward the nine o'clock position, you will add water to bowl. Push downward further to eight o'clock position to flush contents into waste tank. Release pedal slowly to close flush operation.

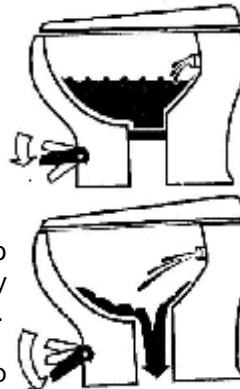

For hand lever operation, pull lever forward to flush. To add water only, pull lever half way forward. When releasing lever(s), do so slowly.

When hooked up to a sewer drain at a camp ground, ALWAYS keep the termination valve CLOSED until the tank is at least 3/4 full. This will provide sufficient water to assist in complete draining of tank.

Manufacturer of toilet, Thetford Corp., offers a complete line deodorants, chemicals, and other convenience products for your use. Your dealer can assist you with these needs and may already have them in stock.

Using Toilet and Tank System

When camping you should always have 4 to 6 inches of water in the toilet bowl. The toilet system performs better when you run water 10 to 20 seconds after flushing to ensure wastes will proceed to the bottom of the tank. Unlike your toilet at home which uses four to seven gallons per flush, the average recreational vehicle system uses two to three quarts. If there is not sufficient water used during

flushing, waste materials may not evacuate properly from drain line to tank. Tank and pipes could eventually become clogged.



CAUTION

It is important to use adequate water to flush and have several gallons of water with chemicals in the tank. This helps the flow of wastes and reduces solid waste build-up.

Vent

A very important part of your sanitation system is the vent system in your coach. These vents release air from holding tanks allowing water to enter. Vent pipes are attached to the holding tank, go through the walls and cabinets to the roof. On some models a portion of vent pipe may be part of the drainage system referred to as a “wet vent”. As air flows upward, water will be draining downward.

Holding Tanks

The final parts of your sanitation system are the holding tanks for waste materials and water. These are located below the floor of your coach.

Gray Tank. Waste water from the bath tub, shower and sinks will drain into this container. No special preparation is required, however, you may wish to add baking soda or a Thetford chemical to reduce odors from food particles in the system.

Waste Tank. The toilet drains into the waste or “black” holding tank. For correct preparation follow the listed steps:

1. Release two quarts of water into the toilet bowl.
2. Place the recommended quantity of chemicals for waste holding tank as per instructions on the bottle into the toilet bowl.
3. Flush liquids into the tank and allow up to two gallons of water to flow into the tank.

Each time you drain the tank, you should follow the instructions listed, before using.

All drain pipes will have a “P-trap” installed into each line. Water in

these traps prevent odors from escaping into the coach. During travel, water from the P-traps may spill and permit odors into the coach. These odors come from fats and food particles decomposing in the tank. By adding water and using a RV approved deodorizing agent, contents will dissolve faster, keeping the drain lines and tanks clean and free flowing. These chemicals are available at a RV supply store.

Draining the Tanks

A final part of your sanitation system is the drainage of holding tanks. Realizing dump stations will vary, place the coach as level as possible to make drainage easier. Some tanks drain from the center requiring unit to be level or slightly up in front. Others will drain from end permitting a slight tilting to the side which drains are on.

Remove the cap and attach the adapter onto the valve housing. Turn the adapter 10° to lock onto the pegs. Attach a flexible sewer hose to the adapter and secure with a clamp. Place the other end into the approved sewer system.

You may now open the 3 inch drain valve to drain the sewage tank first. Open the valve on the gray water tank last to utilize water to wash and rinse the hose and drain lines.

	CAUTION
NEVER leave the gate valve of your coach's sewage tank open when hooked up to a park's sewer system. Open only when you wish to drain system.	

Most states and parks have strict laws and regulations to prohibit dumping of wastes of any kind into anything other than proper disposal facilities or sewer systems. Almost all privately owned parks have either a central pump facility or offer a campsite hookup for sewage. You can find lists of many dump facilities throughout the United States in *Woodall's*, *Rand McNally Camp Guide*, *Good Sam Camp Guide*, *KOA Campgrounds Camp Guide*, or various other publications. Some fuel stations also have dump stations.

	CAUTION
Keep drain valve closed. Sewer gases may be present when RV is connected to campground sewage hookup. If drain valve is open, sewer gases may be vented out the side of the RV. (See owners manual).	

FLUSH SYSTYEM—(Standard on some units, optional on others)

The flush system is designed and built to rinse the waste holding tank, AFTER waste tank has been drained completely of water and solids.

1. Attach a fresh water source to the connection marked “Sewer Tank Flusher”. Be sure termination valves are open on all tanks.
2. Open valve to release water into tank for rinsing and cleaning of your waste water holding tank.
3. Rinse for several minutes to remove any foreign matter from tank, and probes.

Remember the moisture content may give you a false reading on your monitor panel indicating it is full. Allow time to dry out tank or recharge for next usage.



Maintenance for Holding Tanks

The following maintenance is recommended by our holding tank suppliers to keep your tanks clean and keep the probes free of debris and build-up.

Gray (Waste-Water) Tank. Fill tank with 8-10 gallons of warm water. Add a degreaser such as a citrus cleaner or Dawn dish soap. Leave solution in tank while you are traveling. Rinse and drain tank.

Black (Sewer) Tank. Fill tank with 8-10 gallons of water. Add one bottle of drain cleaner, such as Drano or Liquid Plumber. Leave the solution in tank while traveling. Rinse and drain tank.

Heated Holding Tanks

The method used to distribute heat is by placing holes from tank compartment into heat duct built into floor, allowing warm airflow throughout tank area.

This method is not available on all units. Must have cover below tanks for protection.

Winterizing Your Recreational Vehicle

Preparing your trailer for cold weather is very important for most states and Canada. Failure to prepare your coach for cold weather will cause the water systems to freeze resulting in breakage. Damages related to freezing are not covered under the terms of your limited warranty.

Two methods of winterizing your coach after draining and flushing your drainage system are as follows.

Method 1:

1. Open all faucets, low point drains and toilet valve to drain all water. Leave these open during this procedure.
2. Start pump and operate until all water has been removed, takes about 10 to 15 seconds.
3. After water has been drained, use an air hose from a compressor and an adapter attached to city water fill. In about 3 to 5 minutes all water will be blown out of system.
4. Pour one (1) pint (16 oz) of non-toxic RV anti-freeze into each P-Trap. Each sink has a P-Trap, as does the bathtub.

Method 2:

The water heater bypass kit is designed and built to avoid having antifreeze in the water heater. This kit is standard on some models and optional on others.

1. Be sure to turn off the pump.
2. Drain the water heater and the entire water system.
3. Close the valve to water heater on the bottom and top of the by pass kit to prevent liquid from entering the water heater.
4. Place siphon hose into container with anti-freeze.
5. Open the valve V1 on the siphon hose. Be sure V2 is closed.
6. Turn on the pump to supply the fresh water system with anti-freeze. It will take 2 gallons or more, depending on the size of the coach.
7. You may wish to place a container under faucet to catch excess antifreeze.
8. Closest faucets to pump will fill first. Turn faucets off as contents emit antifreeze.
9. Take contents in container and pour 1 pint into each drain to protect each p-trap.
10. Any left over antifreeze in container can be retained for future use.

If you do not have a pre-built siphon hose in your coach, you could purchase or build a kit to attach to the "in" port of the water pump. A by-pass kit is NOT standard on all coaches.

BY PASS KIT

The bottom and top handles on valves of by-pass in horizontal position allows water to flow into and through water heater. These valves are a choice directional flow, not a shut off.

When bottom valve handles are in vertical position it will prevent water from flowing into the water heater. Water will now be directed into the by-pass. The valve on the top needs to be turned, handle turned vertical to allow the water to proceed through the by-pass lines and continue through water system. By turning the top valve, it prevents any back flow into the water heater. Now you can send anti-freeze liquid through coach plumbing system without filling water heater.

Using the Water System During Freezing Weather. Your tow able RV was not intended to be used during freezing weather unless special precautions are taken. Water freezes at 32° Fahrenheit in campgrounds or at home.

There is no product that can be added to the water to ensure freeze protection when the system is in use, other than RV anti-freeze. DO NOT drink water which contains anti-freeze.

 WARNING
DO NOT use Ethylene Glycol (automotive antifreeze) or Methanol (windshield washer antifreeze) in your fresh water system because they are harmful and may be fatal if swallowed!

PROPANE FUEL SYSTEM

The fuel system in your recreational vehicle has numerous components such as, piping, copper tubing, brass connectors, hoses, regulators and appliances. Each of these components will be explained in its appropriate area.

Propane is the only fuel permitted to be used in a recreational vehicle and its appliances. This product is refined from crude oil through natural gasses. An agent has been added for detection should a leak occur or a valve accidentally be left open. It is important for a recreational vehicle owner to recognize and identify the smell of propane vapor.

Other fuels are available but CANNOT be used in a RV because:

1. No orifices for appliances are available for either butane or natural gas fuels.
2. Butane also CANNOT be used below freezing temperature because boiling point is 30 degrees F.

Propane fuel is stored in liquid form under high pressure in special containers. Boiling point is (minus) -44°F , the temperature when vapor ceases to flow. Fuel will change to vapor when released from the container. Appliances are not designed to operate with liquid. Liquid will damage o-rings in valves and also leave sticky, oily residue causing poor or no operation in the regulator.

For every 10 degree increase in temperature, the pressure of propane in container rise's 1.5%. Example—fill at 0 degrees in the north, go south to 80 degrees, your container is now filled at 92%, a potential problem with the 10% valve spewing out propane vapor.

Propane Container

The propane cylinder is a D.O.T. approved container to hold liquid under high pressure, normally a 20 or 30 pound capacity.

The open/closing valve, referred to as an OPD cylinder valve, is to be closed at all times unless hooked up to a propane system or when filling the container.

Valve assembly actually has 3 valves in one body.

OPD Cylinder Valve

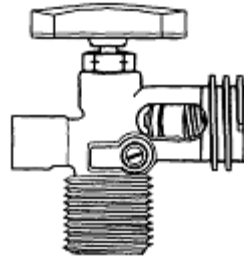

1. Main pass thru portion to fill container and draw propane out is controlled by upper 3-sided knob on top.
2. A small screw on the side of main body referred to as the 10 % valve which allows air to be released and indicates when container is filled to 80% capacity.
3. Incoming positive seal valve MUST be pushed inward with fill nozzle or by POL fitting to draw vapor out for appliance use.

On the bottom/inside of container is the float which closes when 80% of capacity has been reached. This permits expansion space in tank when temperature rises. See section on main hoses.

At any point a container is disconnected, BE SURE to install the "dust cap" over valve entry (if so equipped)

Whenever the container is detached from the propane system, DO NOT allow the cylinder to move or roll around during transportation to and from the gas supplier.

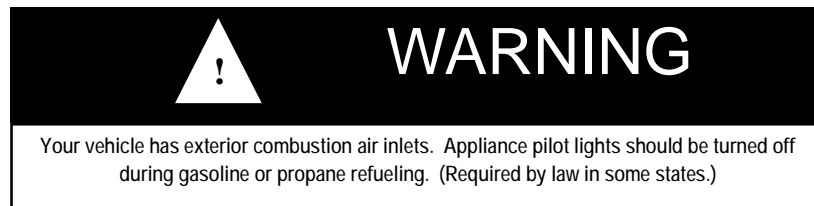

Servicing and Filling Propane Containers

Filling a propane container must be done carefully and correctly. Only a qualified person, properly trained on inspection, filling and safety procedures, should fill containers with propane only.

To remove the propane containers for refilling.

1. Remove the bottle covers (if used).
2. Close the main valve on the container.
3. Remove the two hoses at the ACME connection.
4. Install the rubber cap over the valve ACME connection.
5. Remove/loosen the wing nut holding the clamp hook.
6. Remove the clamp hook.
7. Fill the bottle and reverse the procedure to install. Test all connections for leakage.

A new container MUST be "purged" before placing into service and MUST NEVER BE OVERFILLED. Purging is an operation performed by your dealer or propane agency to remove any atmospheric air.

As an owner you need not be concerned regarding this procedure unless you permit the valve to be in OPEN position when empty.

Two overfill devices are built into the valve to prevent overfilling of the container. First, is the small brass “knob” or “screw” inside of the valve. This “10% valve” must be open when filling, allowing air to escape. When the container reaches 80%, at full capacity, vapor appears. Shut the supply filling valve off. Close the 10% valve plus the top handle of the main valve. An internal float also limits propane intake.

When refilling propane containers, they are generally removed from propane compartment or tie downs. BE SURE to reinstall correctly, as shown in installation instructions, and test for leaks.

When propane containers are filled to 80% level there is available space for safe expansion of the vaporized liquid. Should your container become slightly overfilled, pressure may rise due to hot sun.

WARNING

A warning label has been located near the propane container. This label reads as follows:

DO NOT FILL CONTAINER(S) TO MORE THAN 80 PERCENT OF CAPACITY.

1. Overfilling the propane container can result in uncontrolled gas flow, which can cause fire or explosion.
2. A properly filled container will contain approximately 80 percent of its volume as propane.

Over full pressure, could cause the overflow valve to “blow-off” and emit a small quantity of propane vapor. This can be detected by a strong odor around tanks. Keep open flames away from this area. It is best to remove the bottle, take it to a safe area, and burn -off with a torch, the excess pressure by opening the valve slightly and closing it when discharge has been sufficient, several minutes. When disconnecting propane containers, you must turn the ACME fitting in a clockwise direction because left-hand threads are utilized. When reconnecting, turn connections counterclockwise. Connections must be tight, however DO NOT over-tighten.



Installing Propane Containers

KZ recreational vehicles are equipped with 20 or 30 pound propane containers, depending on floor plan models.

Mounting and attaching instructions are listed below:

1. Thread the long rod into the base plate.
2. Set both bottles into place as shown.
3. Drop the double hook bracket over the rod and hook onto the bottle.
4. Attach the wing-nut to hold the bracket and tighten to hold the bottle to the plate.
5. Attach the regulator with the vent down to the bracket.
6. Attach the main hose from the regulator to the manifold fitting in the frame.
7. Attach two short pigtail hoses to the regulator and bottles at the ACME fitting.
8. Test all propane connections for leakage.

A warning label has been located near the propane container. This label read as follows:

	DANGER
All pilot lights, appliances and their igniters (see operating instructions) shall be turned OFF before refueling of motor fuel tanks and/or propane containers. FAILURE TO COMPLY COULD RESULT IN DEATH OR SERIOUS INJURY.	
	DANGER
Never smoke during the filling of propane tanks. Keep the recreational vehicle away from immediate filling area when possible or extinguish all gas pilots.	
	CAUTION
DO NOT use tools to open or close the tank valve. HAND TIGHTEN ONLY to avoid damage to the valve or handle.	

1. Knob to open and close main valve.
2. Complete valve assembly.
3. "10% valve", (small brass knob or slot screw).
4. Container mounting stand.

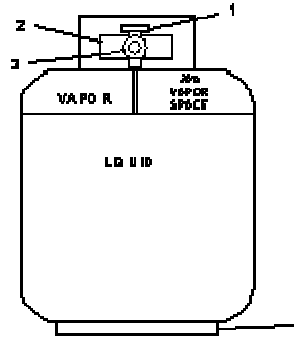

CAUTION

THIS GAS PIPING SYSTEM IS DESIGNED FOR USE WITH PROPANE ONLY. DO NOT CONNECT NATURAL GAS TO THIS SYSTEM.

Securely cap inlet when not connected for use. After turning on gas, except after normal cylinder replacement, test gas piping and connections to appliances for leakage with soapy water or bubble solution. Do not use products that contain ammonia or chlorine.

ALL GAS LINES HAVE BEEN CHECKED WITH AIR PRESSURE. DEALERS ARE REQUIRED TO RECHECK BEFORE DELIVERY TO RETAIL CUSTOMERS.



DANGER

Propane cylinders shall not be placed or stored inside the vehicle. Propane cylinders are equipped with safety devices that relieve excessive pressure by discharging propane to the atmosphere.

FAILURE TO COMPLY COULD RESULT IN DEATH OR SERIOUS INJURY.

Regulator

Propane regulators must always be installed with the regulator vent facing downward. Regulators that are not in compartments have been equipped with a protective cover. Make sure that the regulator vent faces downward and that the cover is kept in place to minimize vent blockage that could result in regulator not operating correctly.

The regulator has the only moving components in the propane system. It's sole function is to reduce the high and varied pressure from the propane containers to safe and consistent low operating pressure. The small inlet is the first stage, which reduces the container pressure to 10-13 pounds.

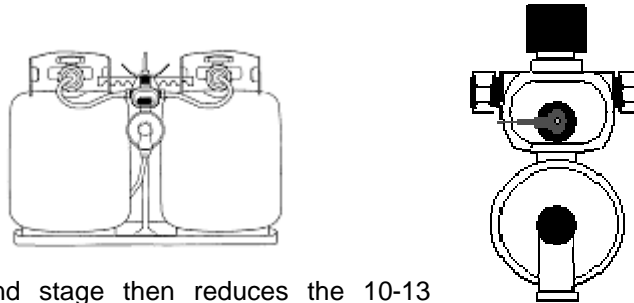

The second stage then reduces the 10-13 pound pressure to an operating pressure of 11 inches w.c. (water column) or 6.35 ounces of outlet pressure to your appliances. The second stage is adjustable and may need to be adjusted for precise operation. We suggest this to be normal maintenance and performed once per year. Do not make this adjustment without a manometer. This instrument is required to read actual pressure.

If pressure is too high, it affects performance and safety. Should pressure be too low, appliances will not operate correctly. An authorized technician with proper equipment should perform such tests and make adjustments, as required.

Two types of propane regulators are used on KZ products. First, is the standard two stage regulator with a brass T-check fitting to connect two propane bottles. We suggest opening only one bottle at a time. Should you open both bottles, they will draw vapor together, resulting in both tanks becoming empty at the same time. This standard regulator is used on smaller coaches.

The second type is the "automatic" two stage regulator used on larger coaches (optional on smaller coaches). With both cylinders

full of propane, turn the lever on the regulator towards the cylinder you wish to use first. This will now be the “supply” cylinder and the other “reserve”. Slowly open both cylinder valves.

The indicator on top of the regulator will turn bright green. When the cylinder becomes empty the indicator will change to bright orange. Now turn the lever to the side of the full bottle and the green signal will return. You may now remove the empty bottle to have it refilled without interrupting the flow from the full bottle. After filling the cylinder, connect the pigtail hose and slowly open the bottle valve. Do not forget to check for leakage each time you refill cylinder or disconnect any part on the propane system.

High Pressure Hoses with Acme Connectors

Propane leaves the container through a hose with an ACME connector attached to the bottle, also having a “flow-limiting device” designed to sense **excessive** flow. Two functions of this device; 1. Should container valve be opened too quickly this device may close, stopping the flow of propane. 2. Should there be a rupture in propane line, it will reduce the flow to (SCFH) Standard Cubic Feet per Hour.

This device will equalize normal flow in about 5 seconds, generally not noticeable.



Main Supply Hose – Low Pressure

The main supply hose will be attached from the regulator to the brass manifold fitting in the frame of the coach. The swivel brass nut on the main hose will be your final attachment.



3/8" MPT x 1/2" Female
Flare Swivel

There are several things to remember each time the container is removed:

1. Be sure ALL fittings are tight. Always use two wrenches for brass connections.
2. Be sure ALL connections are tested for leakage.
3. Open the main valve slowly to avoid a fast rush of propane to flow-limiting device causing gas “freeze”.

4. Listen carefully—a ‘hissing’ sound longer than one second may indicate a gas leak. Close valve and search for leak..

Should you experience a propane “freeze-up”, close the main valve and wait 15 minutes before trying again. Keep the container valve (s) closed when traveling. Some states prohibit traveling with the propane container valves open, especially in underground tunnels on expressways.

Operation

After the camper is completely set up and you are prepared for camping enjoyment, follow these steps for propane operation.

1. Be sure ALL burner valves, controls, and pilot light valves are closed.
2. Light appliances as needed and directed in Chapter Five - Appliances.



DANGER

IT IS NOT SAFE TO USE COOKING APPLIANCES FOR COMFORT HEATING. Cooking appliances need fresh air for safe operation.

Before operation:

1. Open overhead vent or turn on exhaust fan.
2. Open window (s).

FAILURE TO COMPLY COULD RESULT IN DEATH OR SERIOUS INJURY.

Unlike homes, the amount of oxygen supply is limited due to the size of the recreational vehicle, and proper ventilation when using the cooking appliances avoids danger of asphyxiation. It is especially important that cooking appliances not be used for comfort heating, as the danger of asphyxiation is greater when the appliance is used for long periods of time.



FAILURE TO COMPLY COULD RESULT IN DEATH OR SERIOUS INJURY.

Checking for Leaks

The entire propane distribution system and appliances have gone through complete factory and dealer tests for any leakage. When traveling with your RV, normal vibrations and road movement may cause connections to loosen and develop leaks.

For normal maintenance we advise all owners to test for leakage at least once per year or more often. You may request your dealer to perform a maintenance check each spring.

Should you encounter an odor, possibly propane, turn off any and all open flames and begin a systematic search for leaks on the complete propane system. NEVER USE A MATCH. Use a soapy water solution which contains NO AMMONIA, or CHLORINE content to check for leaks. If a leak is identified, bubbles will appear. ALWAYS use two wrenches when tightening brass connections to prevent twisting of copper.

	DANGER
If You Smell Propane:	
<ol style="list-style-type: none">1. Extinguish any open flames, pilot lights, and all smoking materials.2. Do not touch electrical switches.3. Shut off the propane supply at the tank valve(s) or propane supply connection.4. Open doors and other ventilating openings.5. Leave area until the odor clears.6. Have the propane system checked and leakage source corrected before using again.	
FAILURE TO COMPLY COULD RESULT IN EXPLOSION RESULTING IN DEATH OR SERIOUS INJURY.	
	DANGER
Portable fuel-burning equipment, including wood and charcoal grills and stoves, shall not be used inside the recreational vehicle. The use of this equipment inside the recreational vehicle may cause fire or asphyxiation.	

For your own protection, the preceding warning label has been placed near the cooking area to remind you of the need of oxygen for combustion and breathing. Due to smaller area in your recreational vehicle, there is less oxygen than in your home. Proper ventilation is required when cooking.

It is especially important that cooking appliances **not be used for comfort heating**, as the danger of asphyxiation and unsafe levels of carbon monoxide are greater when the appliance is used for long periods of time.

Propane Consumption

If your propane appliances are operated intermittently, your furnace is naturally the appliance using the most fuel, especially if freezing conditions are present outside. On a very cold and windy day it is conceivable that your coach could consume most of a 30 pound propane bottle.

Propane consumption depends mostly upon individual use of appliances and the length of time operated. Each gallon of propane produces about 91,500 BTUs of heat energy. Following is a list of typical appliance consumption when turned on fully for one hour of operation:

APPLIANCE	LP GAS CONSUMPTION
Water Heater	12,000 BTU
Furnace	20,000-35,000 BTU
Stove/Oven	6,500-9,100 BTU
Refer	1,200-2,200 BTU
Note: The above chart represents many different models.	



CAUTION

If you have double bottles and a standard regulator on your RV, use only one bottle at a time. Otherwise the gas supply will be drawn equally from both bottles until supply has been totally exhausted. Using one bottle until it is empty, then using the second bottle will allow you to fill the empty bottle at your convenience without being totally out of propane.

ELECTRIC SYSTEM

General Information

The electrical system in your recreational vehicle is designed for using both 120 volt AC (alternating current) and 12 volt DC (direct current) capabilities. All installations and designs are built to comply with safety requirements of ANSI standard 1192, National Electric Code and Canadian Standards Association.

All coaches manufactured by KZRV have 30 amp or optional 50 amp service.

Highly recommend that your RV electrical connection, is not plugged into a household outlet.

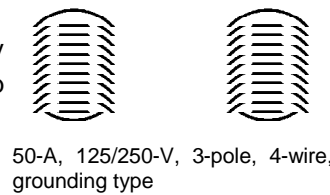
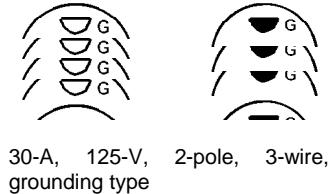

Changes and Modifications

Any changes, alternations, additions, and/or modifications need to be performed by qualified electrical technicians, using only approved components which meet safety and code requirements. This includes owners, dealers, etc. who desire to make changes. The manufacturer is not responsible for any changes, or alterations, made to the 120 AC system of the coach.

120-Volt A/C System

Power Cord 30 AMP or 50 AMP

Power cord is a detachable cord, stored inside of coach for travel. Remove cord and attach to incoming power source and to your coach to receive current.



CAUTION

A 50 amp service is a 240-volt hook-up. There is no appliance or other component requiring 240 volts in this coach. For more information, see the section later in this chapter, 50 Amp (Optional).

Some 30 or 50 amp power cords are detachable from the connector as shown, to be stored inside of your unit when not in use. This cord places 120 AC volt power into your breaker distribution center, as built into your coach.

Energy will enter through the main breaker and is distributed through circuit breakers to the wall receptacles and appliances. This power cord will be approximately 26 to 28 feet in length. Each cord has the correct gauge of wire to carry the correct voltage to coach.



In some hook-ups the power cord may not be long enough and extension cords are required. Always use a cord with the gauge of wire equal to or greater than the power cord. Should you use a cord with a smaller wire gauge, overheating, loss of amperage, and possible melting could occur.

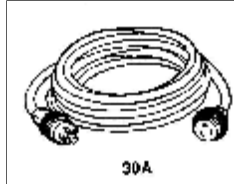

DO NOT leave any unused portion of an extension cord in a "coil" as it may overheat, short-circuit wires and potentially destroy your extension cord.

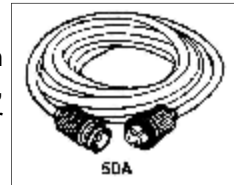

 **WARNING**

Never use a "cheater" plug or extension cord which breaks the continuity of the ground circuit to the grounding pin.

Circuit Breakers and Box—120 volt AC.

On a 30 amp system, a maximum of six distribution circuits are permitted. All breakers are sized according to power needs on each line.

The following generic drawing shows the circuit breaker alignment with number one being the main breaker on all floor plans. Depending on the size, floor plan and options of your coach, circuit three through six will vary and possibly not all circuits will be used. Number two is generally the 20 amp air conditioner circuit.



DANGER

Do not replace breakers or fuses with any that are rated at a higher amperage. Over fusing may cause a fire by overheating the wire.

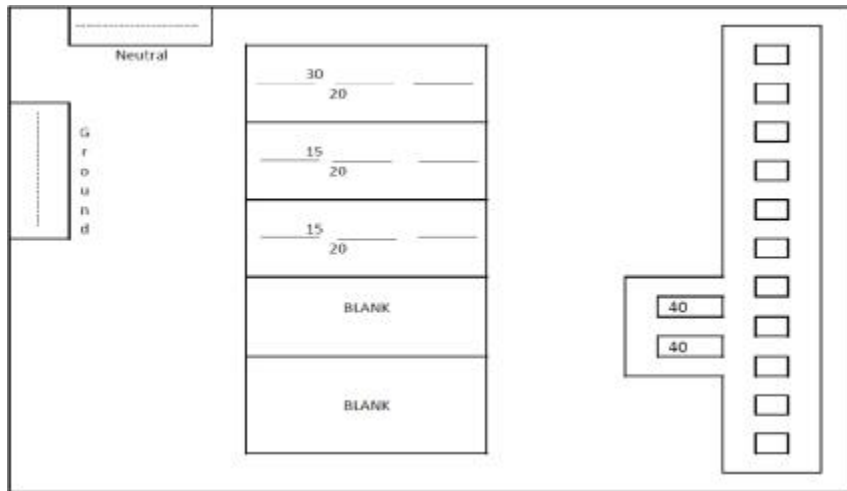

WARNING

NEVER, under any circumstances, remove a grounding pin in any cord or plug. It may mean the difference between LIFE OR DEATH.

An owner must realize and understand that a coach has a total of 30 amp service available to be used. Conserving and choosing which appliance has priority in consumption needs to be part of the planning.

Don't forget loose items such as toasters, electric skillets, and coffee pots also consume power. Include these also in your planning. 50 amp service provides another option.

50 Amp (Optional)

On some larger coaches, more appliances that require more 120-volt AC power are desired by owners. Availability of 50 amp service is the best method providing you have 50 amps of incoming power.

For this application a larger circuit breaker box is required as there are two separate banks of 120-volt AC power on the positive position. Each positive bank receives a 120 volt wire marked "X" or "Y" plus a white neutral wire and green/bare ground to complete circuitry.

Actually, these two positive wires added together are 240-volt AC service, yet serve two separate banks as the external sticker indicates. A 50 amp main breaker will distribute current to separate banks, verifying 240 volts are present. There are no 240 volt appliances in this coach.

If use of a "reducing" adapter or pigtail is needed because 50 amp/ four prong service is not available, several things must be remembered.

1. A "reducing" adapter prevents you from using 50 amp service as designed, permitting only 30 amps to enter.
2. Should you choose to plug your camper power cord into a building receptacle, BE SURE IT DOES NOT have (2) two positive wires which will be 240 volt A.C. power.

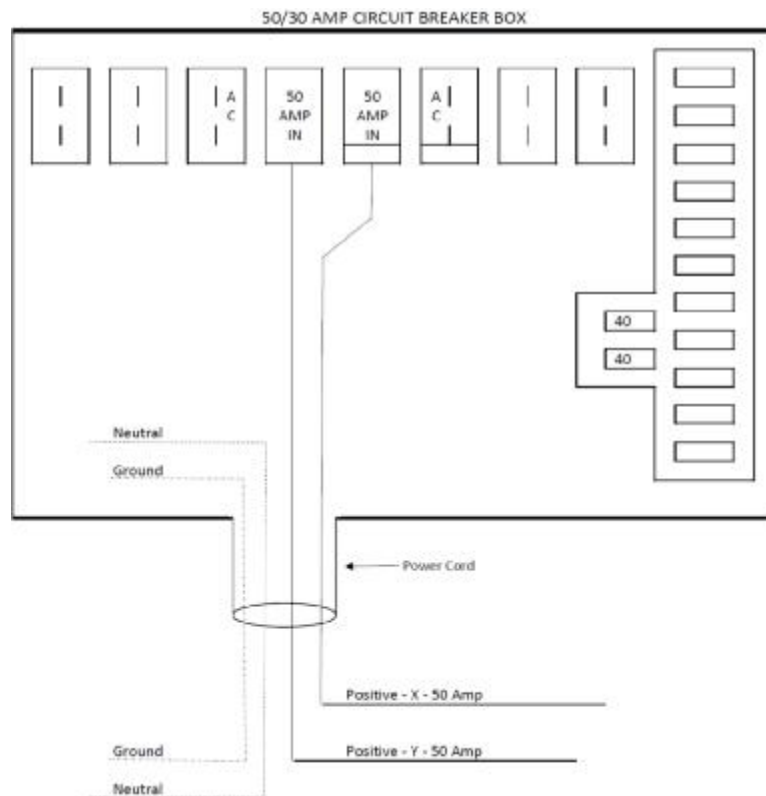



WARNING

DO NOT connect 240 volt direct power to the coach through a reducing adapter. By doing so, "positive" power will be sent through neutral/white wire damaging appliances.

GFCI Protection

Each coach has a GFCI, Ground Fault Circuit Interrupter, protection receptacle installed into the circuitry. This GFCI device is designed to protect people from hazards of line to ground electric shock. The purpose is to reduce possible injury caused by electrical shock, resulting from faulty insulation, improper polarity and related to moisture and/or earth ground.

**THIS CONNECTION
IS FOR 120/240
VOLT AC, 3-POLE,
4-WIRE, 60 HZ
50
AMPERE SUPPLY.**

The third "round" pin on the receptacle is very important for this safety device to function correctly. NEVER cut off this pin. When using an appliance in the receptacle without this provision, use an adapter with a pigtail to be attached to the receptacle box to complete the circuit.

This GFCI receptacle will not protect against short-circuits or overloads. The circuit breaker or fuse in the electrical panel which supplies power to the circuit provides this protection.

Polarity is extremely important. You should be certain that the polarity of the external power is not reversed, in order to avoid harm to appliances and personal electrical shock. Polarity testers may be purchased in most electrical and hardware stores with the GFCI tester built in.

During use of the recreational vehicle it is suggested to test this receptacle once per month. To test, press the "TEST" button in. The "RESET" button should pop out. Power should now be turned off at this receptacle and any receptacles down line. To restore power push, then release the "RESET" button.

12-Volt DC System

Most interior lights and appliances receive 12-volt DC power through converter output and/or the auxiliary battery. Exterior lights and

brakes also use 12-volt DC power from the tow vehicle battery and/or auxiliary battery through the seven way connector and wire attached to the tow vehicle. Following are explanations of various items.

Converter

The heart of your 12 volt DC system is enclosed inside of the load center, including 12V fuse panel, 120V breaker panel and converter.

Fuse panel may have numerous fuse positions, depending on output size of your converter.

All converters have solid state electronic components internally to produce "clean" 12V DC power.

This load center will have a brown plastic front with a small door to access fuses and breakers.

Some models have fuses and breakers in a distribution box, with converter installed in a different location (not mounted into distribution box). This is the 50 amp option.

The function of a converter takes 120-volt AC power and transforms this energy into 12-volt DC power as used in your coach. 12-volt DC supplies power for some appliances and most interior lights. The floor plan and size of coach indicate the output size.

When the converter receives 120 AC power, it transfers power into 12-volt DC without any manual switches. The converter also charges the auxiliary battery(s) when installed on the coach and attached to 120-volt AC power. The third function of a converter is to send 12-volt power to the fuse panel and throughout the coach.

Each converter has a "built-in" fan which operates through a load sensor control or temperature sensor. As more current is drawn, fan will speed up, run faster, or slow down, based on amp draw and/or temperature. Should the fan not run at all, the converter may overheat and will cut-out and/or stop.

Auxiliary Battery (Optional on Some Units)

All travel trailers and fifth wheels are pre-built to accept a battery. Batteries are not standard equipment, or offered as an option on units. They can be purchased from your dealer or battery store.

Recommended batteries are of deep-cycle type as you need longer, slow consuming power rather than cold-cranking power. A battery is always required for a break-away switch to function, a legal requirement in most states.

A battery requires routine maintenance for long life. First, terminals need to be kept clean to avoid corrosion. Second, a battery used daily will consume water as long as the converter is in operation. Be sure to check the battery no less than every 30 days and keep the battery filled with distilled (rain) water. Most good deep cycle batteries are NOT maintenance free.

A converter will not overcharge a battery unless a battery has a dead cell, or the converter has a malfunction. Some type of converters have full battery charge shut-off. Other types reduce the rate of charge as battery conditions reach 12.7 volts DC or 1.265 specific gravity at 80°F. By electronic standards, a battery is discharged at 10.5 volts. Dropping voltage lower than 10.5 volts will begin damaging plates in the battery.

The interior lights will operate from the converter and/or auxiliary battery. Some lights will have wall switches and other lights have switches in the lights themselves.

Circuit Breakers and Fuses—12 Volt DC

These two items have been installed in your coach to protect circuitry and components:

Fuses are placed into the fuse panel with the converter or into a separate panel near the converter with access inside of coach. Fuses are placed in your electrical system to protect wiring and components when overloads appear or short circuits occur. Radios, stereos and possibly other components may have “in-line” fuses attached to their own wire harness.

Two 40 amp fuses are placed in converter, protecting convertor should you connect a battery up backwards. Fuses will blow rather than damage your convertor.

Circuit breakers are placed at several locations. An automatic reset breaker is placed within 18 inches of the auxiliary battery. Breaker will automatically reset upon “cool down”, normally 60 seconds.

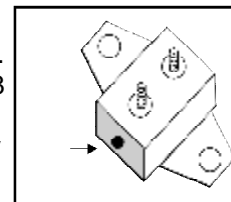

A (30 amp) automatic reset breaker is installed in the load center to operate your slide-out s).

All wiring used in your coach meets correct amp rating correlated with fuses and breakers in respective panels as required by code.

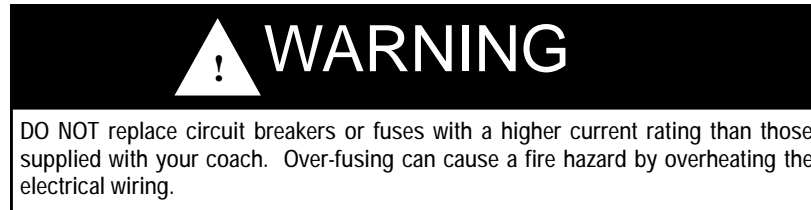

The RV battery is placed in parallel circuitry with the battery on your tow vehicle. Care needs to be exercised not to drain both batteries together. There are two methods of avoiding this condition:

First, disconnect the tow vehicle when parked and/or using your coach.

Second, a battery isolator may be installed in your tow vehicle to prevent power drain from batteries in both vehicles. This device "isolator" has two useful purposes. First, it sends current from the alternator to both batteries simultaneously. Secondly, the isolator prevents draw from the recreational vehicle through the battery of the tow vehicle, preserving power to start the engine.

Contact your dealer should you desire an isolator for your protection. Two types are available, mechanical type, or solid state which is the best and most expensive

Exterior Lights and Connector, 12 Volt

Power for exterior lights, such as tail lights, turn, clearance and brake lights, is supplied by the tow vehicle.

Note the diagram (following page) showing the color code and numbers from the seven way connector and how power is fed to the exterior lights. The positive red wire is attached to the battery to transfer power to the coach.

The connector between the recreational vehicle and the tow vehicle may build up corrosion due to moisture. You may need to clean these terminals occasionally to insure good electrical contact.

Porch Lights

Porch lights are placed on sidewalls, left and right side. Switches for these lights, depending on models, will be in the interior, right and possibly left sidewall. Occasionally, the switch will be on the light itself.

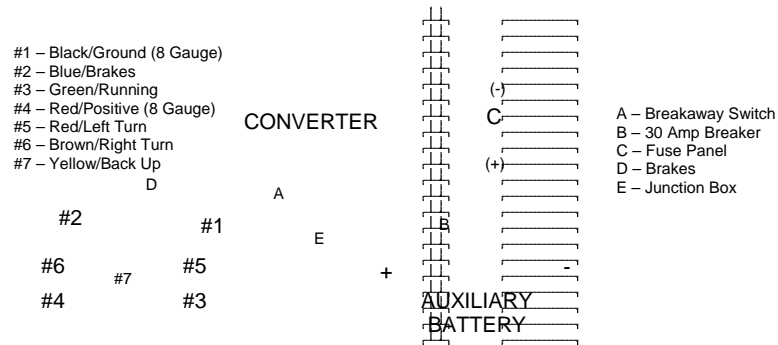

Brake Wiring

Both 10 and 12 inch electric brakes operate on 12-volt power supplied from the tow vehicle, transferred through the blue-positive and white-negative in the seven way harness. There are no fuses or breakers installed in this brake wiring. More information on the brake system is found in Chapter Three - Using Your RV.

If experiencing any electrical problems, check the following items, fuses, breakers, and connections. If none of these items resolve the problem, contact your dealer for trouble shooting, and needed repairs.

CAUTION

Any electrical installation that does not meet the criteria of the manufacturer's specification will VOID THE WARRANTY on the electrical system.

CHAPTER 5 APPLIANCES

KZRV places brand name, quality-built equipment, as guided by current codes and standards, in all recreational vehicles. Some appliances are built and equipped to operate on propane ONLY. DO NOT attempt to operate on natural, butane or methane gas.

Each appliance has its own specific manual, written and published by its manufacturer. These manuals supply additional information about the appliances in your recreational vehicle.

The first 4 appliances in this chapter, all use propane for their MAIN source of fuel, some use 12 volt DC and 120 volt AC energy also. Chapter 4 has more information on propane and it's use.

IT IS VERY IMPORTANT THAT YOU AS AN OWNER AND OPERATOR ARE FULLY AWARE WHAT THE SMELL OF PROPANE IS.

The below "danger" information is placed in the manual and also on a sticker located inside your coach.



DANGER

IF YOU SMELL PROPANE

- 1. Extinguish any open flames.**
- 2. Do NOT touch electrical switches.**
- 3. Shut off propane supply at container valve.**
- 4. Open doors and windows for ventilation.**
- 5. Leave the area until odor clears.**
- 6. Have system repaired before using again.**

**FAILURE TO COMPLY COULD RESULT IN
SERIOUS INJURY, EXPLOSION OR DEATH.**

FURNACE

The furnace in your recreational vehicle requires 12-volt DC electrical current and propane gas energy for correct operation. The furnace receives 12-volt DC power from a fully charged battery and/or the converter in the coach. This power must be present before propane gas can enter through the control to the burner tube.

The combustion chamber is completely sealed to prevent any carbon monoxide or propane from entering into the coach. Oxygen is drawn into the chamber through the upper vent and exhaust fumes expelled through the lower vent.

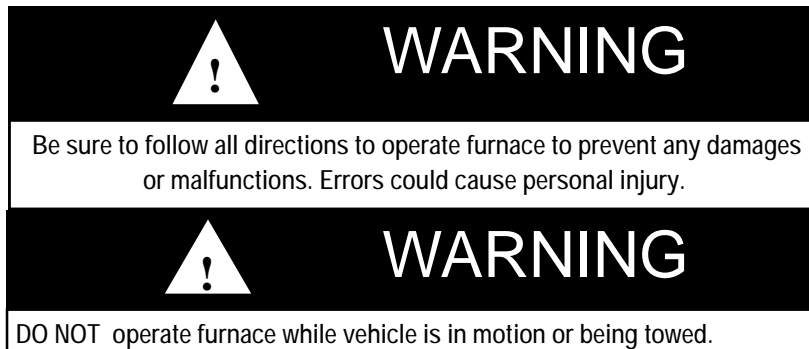

The basic operation of furnace is performed by thermostat mounted on interior wall of your coach, for both ducted and blow thru, (with out duct work) furnaces.

THERMOSTAT (with air conditioner)

OFF=Means all electrical current is turned off and nothing will operate until power becomes available to place heat or cooling inside of coach.

HEAT=In this position, furnace will become active and place heat inside of coach.

COOL=Cool air will be produced from air conditioner.

FAN= Fan only will be in operation only.

Slide switch in center of thermostat will set temperature as desired.

On the right side is a switch for fan operation, with 2 speeds for air conditioner , either low or high speed. Furnace has only 1 speed.

THERMOSTAT (with out air conditioner)

Upper left side has an on/off switch to engage electrical current for operation. Same lever will also set temperature as desired.

A third type of thermostat is used only when air conditioner has a 'HEAT PUMP'.

From the time you turn the thermostat on, there is a delay built into the furnace to perform a purge cycle preventing any possible propane vapor build-up in the chamber.

NOTE: Different model furnaces are used for different unit floor plans. Each model furnace has it's own Users Manual. The following instructions may vary slightly from the instructions in your unit. Therefore it's very important that you refer to the Users manual provided in your unit.

Operating Instructions

1. Before using your furnace, it is suggested to open entrance door and windows to air out camper for any unusual odors such as propane or other.
2. Be sure propane container has fuel and valve is open.
3. Release thermostat from "OFF" position and onto "HEAT" position.
4. Set temperature 5 to 8 degrees above room temperature.
5. Blower will start in 0 to 15 seconds, run for 30 seconds during heat chamber "PURGE" cycle, removing propane vapor, if any.
6. Second cycle, blower continues to run, module board will: (a) Send spark to burner tube, (b) Open valve in control to release propane to burner tube.
7. Ignition attempt will be for 7 seconds.
8. Failing to ignite, board will make 2 more attempts to light and then go to lockout.
9. If after (3) attempts with no ignition, drop thermostat to lowest setting, wait 1 minute and repeat steps 4 to 7.
10. After burner tube lights, set thermostat to desired setting.
11. To shut burner down, move thermostat to lowest setting or "OFF"
12. Blower will continue to run for about 2 minutes until heat is removed from chamber.

To Turn Appliance Off

1. Set the thermostat to the lowest setting , then move lever to “OFF” position.
2. Turn off all electrical power to the appliance if service is to be performed.
3. ALL furnaces have a 12 volt switch built on the furnace and must be turned “ON” for furnace to operate. Some models may have a wood panel cover, in front of switch, making it difficult to have access to it.



WARNING

Do not install screens over the vents for any reason. Screens will become restrictions causing unsafe or inefficient operation.

External Vents. Always be sure these vents are clear of any objects like screens, duct tape, etc.

Ducting. Wall or floor registers, and return air grills MUST be kept clear of any obstructions. Any such restrictions will prevent the furnace from correct operation. Closeable registers will reduce air flow. Never shut registers off completely, possibly causing furnace to limit out and shut down.

Propane pressure, as defined in Chapter Four - Systems, is extremely important. A dial gauge or U-tube manometer is required to perform tests and adjustments. Pressure must be set at 11 inches w.c. (water column) plus or minus 1/2 inch. Incorrect gas pressure can cause any appliance to operate inconsistently and cause poor combustion. Only qualified technicians with proper training and equipment should make any mechanical adjustments.

Voltage must be between 10.5 volts to 13.5 volts at the furnace during operation. Below 10.5 volts the furnace will shut down. Both high and low voltage places excessive wear on the motor and brushes.

Any mechanical adjustments, such as electrode adjustments, should be performed by a qualified service technician.

RANGE AND OVEN TOP BURNER OPERATION

Several types of cooking appliances are used in KZRV products; a drop-in stove with two or three burners in the outside kitchen, and a standard oven with three top burners with piezo lighter. Oven has a standing pilot, **MUST** be lit with match or hand held lighter. These appliances operate with propane only, **NEVER** natural gas or butane.

Read the **SAFETY** and **WARNING** instructions in front of furnace instructions



WARNING

Be sure all control knobs are turned "OFF" when you are not cooking. Someone could be burned or a fire could start if a burner is accidentally left on or unattended even if only momentarily.

Before attempting to light stove, top burners or oven, **BESURE** the valve on your propane container is turned open.

Drop-In Stove 2 burner or 3burner WITHOUT Piezo Ignition *Operating Instructions*

TOP BURNERS

1. Know which knob controls which burner. Always be sure all burner valves are turned off when the stove is not in use.
2. Verify sufficient propane supply before attempting to light the burner ports.
3. Depress knob and turn fully counterclockwise to "LITE" position.
 - a.. Air in the propane line will significantly delay burner ignition. The burner may light unexpectedly as the air in the lines clears and is replaced with propane. This unexpected ignition could burn you. Air in the propane lines may occur after the vehicle propane bottle and/or tank is refilled, during and after servicing other appliances on the same propane line, or not used for a period of time, (etc).
 - b. Do not attempt to light more than one burner at a time.
 - c. Immediately light the burner by holding a long match or handheld lighter near the burner ports.
 - d. If the burner should go out while cooking, or if there is an odor of propane, turn the control knob (s) clockwise to "OFF".

Wait five minutes for the propane odor to disappear. If the propane odor is still present – DO NOT relight the burners. See instructions in the appliance manual.

4. To turn the burner (s) off, turn the appropriate control knob clockwise to “OFF”.

	CAUTION
Hand held igniters may be used but be sure they are the type designed for lighting open flame burners.	
	WARNING
When holding the match or lighter to ignite flame, DO NOT position your fingers close to the burner. You could get burned causing injury.	
	WARNING
DO NOT OPERATE THIS APPLIANCE UNLESS ANY PRIVACY CURTAIN IS SECURED. FAILURE TO COMPLY COULD RESULT IN FIRE OR SERIOUS INJURY.	

Oven and Range Combination Stove Top Ignition System

Top surface burners have piezo lighter. Matches and handheld lighters may be used if igniter does not work.

1. Know which knob, controls which burner. Always be sure all burners are turned off when the stove is not in use.
2. Depress knob and turn fully counterclockwise to “LITE” position. Turn igniter clockwise to produce spark for ignition.
 - a. Verify sufficient propane supply before attempting to light the burner. Air in the propane line will significantly delay burner ignition. The burner may light unexpectedly as the air in the line clears and is replaced by propane. This unexpected ignition could burn you. Air in the propane lines may occur after the vehicle propane bottle and/or tank is refilled, during and after servicing other appliances on the same propane line, etc.

B. DO NOT attempt to light more than one burner at a time.

3. If any burner should extinguish after initial lighting or due to accidental blow out, turn propane off by turning control knob clockwise to “OFF”. Wait five minutes before attempting to relight the burner.

If the burner should go out while cooking, or if there is an odor of propane, turn the control knob (s) clockwise to “OFF”. Wait five minutes for the propane odor to disappear. If the propane odor is still present – DO NOT relight the burners. See instructions in the appliance manual.

4. To turn the burner (s) off, turn the appropriate control knob clockwise to “OFF”

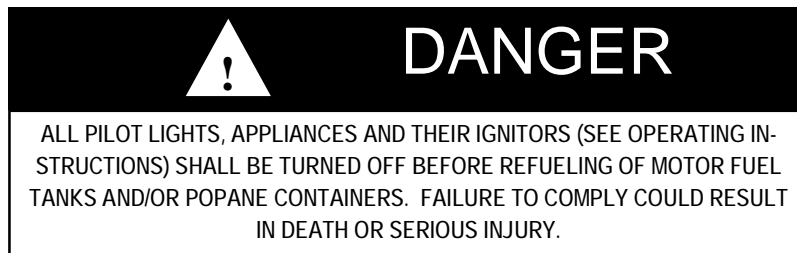

OVEN BURNER

Note: Before the oven burner will operate, the oven pilot must be lit.

1. Lighting Oven Pilot
 - a. Be sure ALL valves are in the “OFF” position. The oven control knob should be in the “Off” position.
 - b. Be sure main propane supply is on.
 - c. Open the oven door; search for propane odor. If you smell propane, STOP! Read and follow the instructions in your appliance manual.
 - d. If you do not smell propane, turn knob to the pilot position.
“Push In /Lite Pilot
 - e. Immediately light pilot with a match or handheld lighter. Hold knob in at least 5 to 7 seconds, for this allows propane to flow to pilot and to heat the thermocouple. Release knob, pilot should stay on. NOTE: If the appliance has not been operated for a long period of time, a longer waiting period for ignition of the pilot may be due to the air in the pilot and propane lines. If pilot goes out, repeat steps a, b, c, d.

2. Operation of Oven Burner

- a. Turn the oven control knob counter-clockwise, to the desired setting. Oven burner will come on immediately and the oven burner will stay on until it reaches the desired setting. Then the oven burner flame will decrease in size. This is normal for this type of thermostat and this flame size will maintain a constant temperature within the oven..
3. To shut down the oven burner turn the oven control knob clockwise to "PILOT ON" position. At this position, the oven pilot will remain lit.
4. To shut down the oven pilot light turn the oven control knob to "OFF", at this position, the oven pilot will go out.

	CAUTION
When the recreational vehicle is not in use or while traveling, it is recommended that the propane supply also be turned off.	

	DANGER
If you do not follow these instructions exactly, a fire or explosion may result causing property damage, personal injury or loss of life.	

WATER HEATER DSI MODELS

Operating Instructions—Gas

This appliance does not have a pilot. It is equipped with an ignition device which automatically lights the burner. Do not try to light the burner by hand.

Do not use this appliance if any part has been under water. Immediately call a qualified service technician to inspect the appliance and to replace any part of the control system and any propane control which has been under water.

Before operating the water heater, check the location of the vent to make sure it will not be blocked by the opening of any exterior door on the trailer. If it can be blocked, do not operate the water heater with the door open.

	WARNING
Before attempting to operate any water heater, you must be sure the heater is full of water. Failure to fill with water will result in the tank warping and the element burning up. When filling water heater with water, don't forget to open the by-pass valve to fill tank.	
	CAUTION
Temperature setting on the control was factory set at the lowest setting to reduce risk of scald injury. Setting the temperature dial past the low position will increase the risk of scald injury. Children, disabled, elderly and diabetics are at highest risk of being scalded.	

OPERATING INSTRUCTIONS: DSI MODEL

1. Full operation and ignition occurs on the external side of this appliance. By removing out side grill, it will evacuate any odors or propane should there be any . Do not light with grill off.
2. Be sure propane supply and 12 volt DC. Power are available.
3. Turn on propane supply.
4. Turn on electric power to appliance.

5. Turn switch marked "WATER HEATER", which is located on the monitor panel to "ON" position. If the burner does not light, the system will automatically attempt two more tries for ignition before lock out. NOTE: Each ignition cycle will have a fifteen second purge before next spark cycle begins again, if the system is a three try board
6. If lock-out occurs before main burner lights, turn switch to "OFF", wait five seconds and turn switch to "ON" position. This will restart the ignition cycle. The first start-up of the water heater may require several attempts before all air is purged from the propane lines.

If the burner will not come on, the following items should be checked before calling a service person:

1. Switch turned off.
2. Propane supply to heater is empty or turned off.
3. Reset button on ECO is tripped.
4. If burner fails to light, call a Suburban Service center or a local RV Service agency.

Operating Instructions—Electric Element

Electric water heaters are designed to operate with a minimum amount of service problems, however proper operation and care is essential.

By far the most common trouble with electric water heaters results from energizing the water heater before it is filled with water. Even brief operation of the electric element without water in the tank will burn-out the electric heating element.

Before the electric element will operate, the switch located behind the water heater door in the lower left corner of the control housing must be in the "ON" position.

To energize the electric element, locate the switch, which is on the bottom of monitor panel, flip the switch marked "ELECTRIC" to the ON position. The water temperature will be regulated by the thermostat.



To Turn Off Water Heater

1. Turn switch to "OFF" Position.

2. Turn off the electric power to the appliance.
3. Turn off propane supply.
4. If the vehicle is to be stored or the heater is going to be turned off while subject to freezing temperature, drain the water heater.



CAUTION

DO NOT operate the water heater with two energy sources in operation or without water.

Winterizing your Water Heater

If your water heater plumbing system is equipped with a bypass kit, use it to close off the water heater. Drain the water heater completely and leave the water heater closed off (out of the system) in the bypass position particularly if you are introducing antifreeze into the plumbing system.

Antifreeze can be very corrosive to the anode rod creating premature failure and leave sediment in the tank. If the plumbing system is not equipped with a bypass kit, and you intend to winterize by adding antifreeze to the system, remove the anode rod (storing it for the winter) and replace it with a 3/4 inch drain plug.

REFRIGERATOR

KZ recreational vehicles use numerous different size and model numbers of refrigerators operating on 120- volt AC and propane. Performance of refrigerators depends on various factors, such as, energy, venting, leveling, humidity and atmospheric heat temperatures, but not limited to these. All refrigerators are designed with absorption type of cooling units requiring careful leveling and venting conditions.

Several large models use a "house type" refrigerator that uses 120 volt AC power only, no propane or 12 volt DC. You cannot keep food cold while traveling. Leveling and venting is not as important as in absorption units.



DANGER

If the user of this appliance fails to maintain it in the condition in which it was shipped from the factory or if the appliance is not used solely for its intended purpose or if the appliance is not maintained in accordance with the instructions in this manual then the risk of a fire and/or the production of carbon monoxide exists which can cause personal injury, property damage or loss of life.



DANGER

If you do not follow these instructions exactly, a fire or explosion may result causing property damage, personal injury or loss of life.

Leveling

For correct operation, the refrigerator **MUST** be within three degrees of level in any direction. Continued operation outside of these limits will result in irreparable damage to the cooling unit in the refrigerator.

Venting

For an absorption unit to operate fully it **MUST** have two vents. The lower vent serves as access to service components and allows air to enter. As the refrigerator heats up, warm air leaves through the upper vent in the roof or the side vent. The roof vent gives the best “chimney” results. With correct baffles, side vent will work. All vents **MUST** prevent birds and rodents from entering.

Units with two-side vents as in slide-outs, require a 12V fan to be in operation. When upper cooling fins reach 150° Fahrenheit, the fan will automatically start to operate. The positive wire has a **five amp** in line fuse installed. Access to the fuse is inside of the lower service vent door.

Whenever your recreational vehicle is stored and not in use BE SURE to turn switch to the "OFF" position avoiding 12-volt DC discharge. Failure to do so results in battery drainage. The 300 and 400 series do not have this option.

Battery Drain Information

To control operating functions on several models of refrigerators, a 12-volt DC power source, battery and/or converter are required. For propane operation .5 amp is required through the power supply to keep the solenoid open to supply propane to the burner as needed to continue to cool.

Door Seal

To maintain cooling efficiency the door must seal completely on all four sides along the door gaskets. Frequent frost build up or reduced cooling are indicators of air leaks around the doors. Place a strip of paper the size of a dollar bill between the flange and door gasket. Close the door and pull the paper out. There should be a light frictional drag indicating proper seal. Should the paper feel loose, the gasket is not sealing well. If the gasket isn't sealing properly, contact your dealer or service center to correct the seal of the door.

Door Latch

A positive or full locking latch is not permitted through codes. Each latch has a rating by pounds of pressure, yet will prevent the door from opening during travel.

CAUTION

Do not use undue force or jerking action when opening the refrigerator door. Air temperature differences can cause a partial vacuum within the cabinet requiring a firm but steady force to open the door. A sudden jerk could cause door damage or personal injury.

Operation in Transit

During camping or parking, the refrigerator MUST be level for best operation. While traveling, the up and down hill movement of the

coach, will not affect the performance of the refrigerator AS ALL CONTENTS ARE IN MOTION.

Defrosting and Cleaning the Refrigerator Interior

Your refrigerator is not frost free and will require periodic defrosting. To defrost, turn the refrigerator off. Empty the freezer and the fresh food compartments. Placing a pan of hot water in the freezer will reduce the defrosting time. Leave the drip tray under the cooling fins. After frost has melted, empty the drip tray and clean the refrigerator.

Add a small quantity of mild dish detergent to lukewarm water and wash the interior of the refrigerator. **Do NOT use abrasive cleaners, they can damage the interior surfaces of the refrigerator.** Rinsing both compartments in a solution of baking soda and water (one tablespoon of baking soda to one quart of water) will freshen the interior and neutralize odors. Wipe the interior with a soft dry cloth to prevent water spots. Clean the door gaskets in the same manner as the refrigerator interior. This will help to prolong the life of the gaskets.

Numerous different models and sizes of refrigerators are used in Spree, Connect, and Sportsmen coaches, according to floor models. See manuals being supplied by the manufacturer for additional information and operating procedures.

Operation of Refrigerator

In order for proper operation, and to achieve proper cooling, 12 volt DC power **MUST** be present at the power supply board for it to function. Power comes from solid state convertor, battery, or vehicle battery.

OPERATING THE REFRIGERATOR CONTROLS—

Two types or system are being used in current production, one is the fully automatic and other type you must choose which energy source you wish to use.

Fully automatic—In the center of control panel there is a single switch . It says “automatic”. Push button to turn power on. To change inside temperature, you need to move “thermister” wire and clip to a different set of fins inside of box, as explained in manufacture’s manual.

Semi-automatic

You have to choose to operate on propane or automatic 120 VAC power.

To change temperature, slide a switch from 1 to 5 with 5 being the coldest.

Additional information will be found in the manual supplied by the manufacturer of the refrigerator for ALL units.

Always pre-cool the refrigerator for 8 hours before placing cold food into box. Additional information is found in the manual supplied by the manufacturer of your refrigerator.

MONITOR PANEL

Your panel through modern technology will supply the charge condition of your battery, and water level information from your water tanks.

Operation requires 12-volt DC power, supplied by the battery or converter. Sensors, one negative and three positive, attached to a resistor feed information to the display panel. To operate, place finger on button and push. A light will illuminate indicating the water level of tanks or charge condition of battery. "Gallery" will light only when floor plan includes the second gray water holding tank.

The switch on the lower left corner is for water pump operation. When in the "ON" position, pump will run until 40 to 45 PSI is achieved. The pump will shut off and restart at 20 pounds of pressure. Turn pump switch "OFF" when pump is not in use.

The red switch in the middle at the bottom of monitor panel is for the water heater LP gas. Red switch, lower right hand corner is for Water Heater electric.

When pushing the battery button, the highest light coming on indicates the battery condition: C-charge at 12.7 volts; G-good at 11.9 volts; F-Fair at 11.2 volts; L-low at 6.0 volts. Press only one button at a time as one set of lights serves all functions.

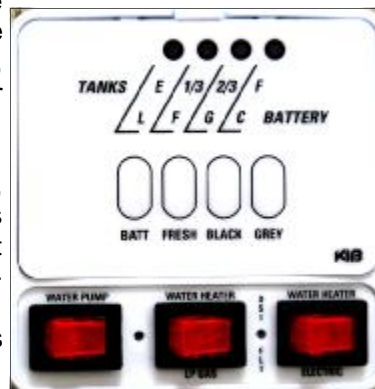

This monitor panel is used in Sportsmen, Spree, and Connect model coaches.

Outside Kitchen (Optional)

Using this exterior kitchen will eliminate traffic inside of your camper and perhaps avoid a food spill.

Two sizes are available, depending on model camper and space, a tall or short version.

1. Cook top is a 2 burner hot plate and has no standing pilot light. Each use requires re-lighting the burner. A removable propane hose is required and supplied with quick connectors for fuel from propane system.
2. A refrigerator is also a part of this package, 120 volt AC compressor type. The small version uses a 1.6 cu. ft. refrigerator, and tall version uses a 3.2 cu. ft. refrigerator. No propane or 12 volt DC is required or available for operation.
3. Small sink and faucet is also a part of kitchen. Drainage of used water will go into the holding tank, thru a flexible hose. It also serves as an outside shower/port. A hose is included.
4. A second microwave is included with the tall kitchen. You will have to choose which one to use. A switch is inside the camper, generally called a "Double pole/Double throw" switch. Since there is only 30 amp service available, which is why you must make this choice.
5. Another feature available on some kitchens is a TV set to watch under the awning and watch programs in fresh air instead of cooking items. A refrigerator may be a part of this group.

PLEASE NOTE; NOT all of these items can be in one kitchen.

Important Phone Numbers
