



GUIDEBOOK TO ENJOYMENT OF
YOUR KZRV
RECREATIONAL VEHICLE

SPORTSTER

THE PURPOSE OF THE OWNER'S MANUAL IS TO PROVIDE THE MOST CURRENT INFORMATION AVAILABLE FOR YOUR NEW RECREATIONAL VEHICLE ABOUT CARE AND USAGE.

ALSO MINOR MAINTENANCE AND CRITICAL SAFETY WARNINGS ARE INCLUDED AND **MUST** BE READ AND OBEYED.

ADDITIONAL MAINTENANCE INFORMATION IS FOUND IN "MAINTENANCE MANUAL" SUPPLIED WITH YOUR COACH. FAILURE TO PROVIDE CARE FOR YOUR R.V. COULD RESULT IN LOSS OF WARRANTY COVERAGE.

ADDITIONAL MANUALS MAY BE SUPPLIED AND AVAILABLE BY THE MANUFACTURER OF THE COMPONENT AND/OR APPLIANCE. SEE THE INFORMATION PACKET IN YOUR COACH.



Conventional Travel Trailer



Travel Trailer Toy Hauler



Conventional Fifth Wheel



Fifth Wheel Toy Hauler



Hybrid Travel Trailer

KZRV
“BUILDING QUALITY AND FUN
FOR OVER 40 YEARS”

We congratulate you on your purchase of a KZRV, recreational vehicle. You have chosen a quality built RV which should provide you with many years of camping memories and fun.

The recreational vehicle you have purchased has been inspected by our trained inspectors and fully meets our high quality standards.

As the owner of a new KZRV, you can rest assured that we will do all we can to keep you a “happy camper”. Naturally, your selling dealership is always happy to help you with any questions you may have or service you may need. And should you need assistance when traveling, with over 250 KZRV, dealers nationwide, assistance is usually just minutes away.



KZRV
0985 N 900 W
Shipshewana, IN 46565

TABLE OF CONTENTS

Chapter 1 – Introduction to RV Ownership	1
Safety Considerations	2
Reporting Safety Defects.....	2
Safety When Emergency Stopping.....	3
Additional Safety Considerations.....	3
Extended or Cold Weather Use	4
Condensation	5
Causes.....	5
Solutions.....	5
Interior Ventilation.....	6
Chapter 2 – Service Procedures	7
Basic Service Procedures	7
Dealer.....	8
Factory.....	8
Parts.....	8
Owner’s Responsibility	8
Seasonal Site.....	9
Towable Limited Warranty.....	10
Chapter 3 – Using Your RV	13
Equipment.....	13
Tow Vehicle	13
Hitches – Travel Trailer.....	13
Hitch Height Specifications – Travel Trailer.....	14
Hook-Up — Travel Trailer.....	14
Hook-Up — Fifth Wheels	15
Front Landing Jacks — Fifth Wheel.....	15
The Safety Chain (Travel Trailer)	16
Traveling.....	16
Weights.....	16
Weighing Vehicle (Loaded or Unloaded).....	17
Loading the Trailer—Distribution	18
Toy Hauler-Cargo Information.....	19
Interior, Cargo Area.....	21
Rear Screen Door.....	22
Rear Cargo Door.....	22
Fuel Cell.....	22
Generator.....	23
Tires.....	24
Understanding Tire Pressure and Load Limits.....	25
Tire Size	25
Tire Tread.....	26
Tire Balance and Wheel Alignment.....	26

Tire Repair.....	26
Tire Fundamentals	26
Tire Speed Rating.....	27
Vehicle Load Limits.....	27
Cargo Capacities	27
How Overloading Affects Your RV and Tires	28
How to Change a Tire.....	28
Wheel Bearings.....	29
Wheel Lugs.....	29
Brakes—Electrical.....	29
Breakaway Switch	30
Towing.....	31
Setting Up and Using Your Recreational Vehicle	32
Travel Trailer Hook Up.....	32
General Detector Information.....	32
Safety Detectors.....	34
Fire Extinguisher.....	34
Propane/ Carbon Monoxide Detector.....	34
What is Carbon Monoxide?.....	34
Dual Sensor Technology.....	34
Operation.....	35
Gas Alarm.....	35
Lower Power Operation.....	36
Visual and Audible Alarm Signals.....	36
CO Alarm.....	36
Propane Gas Alarm.....	36
End of Life Signal.....	37
Smoke Alarm.....	37
Operation.....	37
Testing.....	37
Steps-One or Three.....	38
Windows	39
Doors.....	39
TV Antennas (Standard Roof Mount)	39
Slide Outs	40
Power For Operation.....	41
Trailer Set-Up Requirements-General.....	41
Below Floor Slide System.....	42
Above Floor Slide Out (All Brands and Types.....	42
Electrical Components	43
Manual Override.....	43
Below Floor Slide Out.....	43
Above Floor Slide Out.....	44
Schwintec Wall Slide.....	44
Manual Override.....	44

Blinds.....	45
Entertainment Components..	46
Murphy Bed	46
Chapter 4 – Systems	48
Water and Drainage Plumbing	48
Fresh Water System.....	48
Tanks.....	48
Filling Fresh Water System #1.....	48
Filling Fresh Water System #2.....	49
12-Volt Demand Pump	50
Faucets.....	50
Bath and Shower.....	51
Outside Spray Port.....	51
Fresh Water Lines.....	52
Lo-Point Drains.....	52
Sanitizing and Filling the Potable Water System.....	52
Drainage (Fresh Water).....	54
Sanitation System.....	54
Toilets.....	55
Using Toilet and Tank System.....	55
Vents.....	55
Holding Tanks.....	56
Draining the Tanks.....	56
Flush System.....	57
Maintenance for Holding Tanks.....	57
Heated Holding Tanks.....	58
Winterizing Your Recreational Vehicle.....	58
By Pass Kit.....	59
Using the Water System During Freezing Weather.....	59
Propane Fuel System.....	60
Propane Container.....	60
Servicing and Filling Propane Containers	61
Installing Propane Containers	63
Regulator.....	64
High Pressure Hoses with Acme Connectors.....	65
Main Supply Hose – Low Pressure.....	66
Operation.....	66
Checking for Leak.....	66
Propane Consumption.....	68
Electrical System.....	70
General Information.....	70
Changes and Modifications	70
120 Volt AC System.....	70
Power Cord 30 Amp or 50 Amp.....	70
Circuit Breakers and Box	71

50 Amp (Optional)	72
GFCI Protection.....	74
12 Volt DC System	75
Converter.....	75
Auxiliary Battery (Optional on Some Units).....	76
Circuit Breakers and Fuses-12Volt DC.....	76
Power Cut off Switch for Battery.....	77
Exterior Lights and Connector, 12V	78
Porch Lights.....	78
Brake Wiring.....	78
Chapter 5 – Appliances.....	80
What To Do If You Smell Propane.....	80
Furnace.....	80
Operating Instructions.....	82
To Turn Off Furnace.....	83
External Vents.....	83
Ducting.....	83
Range and Oven Top Burner Operation	84
Operating Instruction.....	84
Top Burners.....	84
Oven Burner.....	86
Water Heater.....	87
Operating Instructions: Propane.....	87
Operating Instructions For Direct Spark Ignition.....	88
Operating Instructions: Electric Elements.....	90
To Turn Off Water Heater.....	90
Winterizing Your Water Heater.....	90
Refrigerator.....	91
Leveling.....	91
Venting.....	91
Door Sealing.....	92
Door Handles.....	92
Refrigerator Storage.....	93
Operating The Refrigerator Controls.....	93
Monitor Panel.....	94
Outside Kitchen (Optional).....	95
Portable Solar Panel Receptacle.....	96
Back-Up Camera.....	96

CHAPTER 1 INTRODUCTION TO RV OWNERSHIP

Welcome to the growing family of new KZRV owners and the world of recreational vehicle travel. The purchase of your KZRV product allows you to enter this type of camping and leisure travel. Your coach has been designed and engineered to offer many comforts of home. KZ Recreational Vehicles are designed and constructed to be used as temporary living quarters for camping and travel uses. The coaches are not intended for hauling cargo.

This owner's manual was prepared to assist you in understanding the proper use and operation of various containment systems, servicing and maintenance of component parts, and explanation of your warranty protection. If this is your first RV travel coach, you will want to acquaint yourself with all aspects and information found in this manual plus manuals supplied by component manufacturers.

These materials will reflect the most current information available for the user. Some components and items may not be in your coach as they may be options on different models.

Keep this owner's manual in your recreational vehicle for handy reference. Get to know your new vehicle and how it operates. You should carefully read and understand these instructions, as well as information supplied by the manufacturers of separately warranted products, since they contain important operating, safety, and maintenance instructions. If you have questions that are not adequately answered by this manual or other booklets, consult your dealer. If he cannot satisfactorily answer your questions, he will call our staff for additional information.

Every effort has been made to provide you with a safe, dependable product. Your vehicle complies with applicable requirements of Federal Motor Vehicle Safety Standards, State Regulations, Canadian Standards Associations (CSA) where applicable, and complies with requirements of ANSI Standard A119.2, the nationally recognized "Standard for Recreational Vehicles – Installation of Plumbing, Heating and Electrical Systems." The Recreational Vehicle Industry Association (RVIA) and Canadian Standards Association (CSA) periodically inspect our production lines and assist us in maintaining strict compliance with installation and safety standards for those systems. **Your follow-up with periodic safety inspections and a program of preventive maintenance is important for the continuation of safe and trouble-free operation.**

Camping is a great way to relax and enjoy the outdoors with your friends and family. Please remember to tread lightly on our beautiful land and leave only your footprints so that others may enjoy nature as much as you did.

SAFETY CONSIDERATIONS

The terms **NOTE**, **CAUTION**, **WARNING** and **DANGER** have specific meanings in this manual as well as component manuals.

A **NOTE** provides additional information to make a step or procedure easier or clearer. Disregarding a **NOTE** could cause inconvenience, but would not be likely to cause damage or personal injury.

A **CAUTION** emphasizes areas where equipment damage could result. Disregarding a **CAUTION** could cause permanent mechanical damage. However, personal injury is unlikely.

A **WARNING** is giving notice to user that potential injuries may occur to a person from equipment and mechanical failure. Disregarding a **WARNING** may result in serious physical injury to occupant.

A **DANGER** alerts areas where safety measures **MUST** be strictly adhered to, as such failures can be dangerous. Disregarding a **DANGER** could cause serious injury and possible loss of life.

Reporting Safety Defects

If you believe that your vehicle has a defect which could cause a crash or could cause injury or death, you should immediately inform the National Highway Traffic Safety Administration (NHTSA) in addition to notifying KZRV.

If NHTSA in addition receives similar complaints, it may open an investigation, and if it finds that a safety defect exists in a group of vehicles, it may order a recall and remedy campaign. However, NHTSA cannot become involved in individual problems between you, your dealer or KZRV.

To contact NHTSA, you may either call the Auto Safety Hotline toll-free at 1-800-424-9393 or write to:

NHTSA
US Department of Transportation
Washington, DC 20590

You can also obtain other information about motor vehicle safety from the Hotline.

Safety When Emergency Stopping

It is wise to carry road flags and/or triangular warning devices to be used when necessary. When pulling off a highway, use your four way hazard lights as warning flashers, even if only to change drivers. Pull off the road way completely if at all possible to change flat tires or any other emergency needs.

Additional Safety Considerations

1. Sanitize the fresh water supply system periodically (see sanitizing instructions).
2. Keep water connection fittings from coming in contact with the ground or drain hose to reduce chance of contamination.
3. Enlist services of a Qualified RV Technician to test, repair if needed, or replace any electrical or propane appliances in your RV.
4. Always have a serviceable fire extinguisher placed in an easily accessible location.
5. Insure that tires are in good condition and properly inflated. Watch tire inflation closely. Under-inflated tires will overheat. Check the tire pressure before each trip while the tires are cold.
6. Check and tighten the wheel lugs regularly (every 50 miles when new until 200 miles are reached and then check the lugs every 500 miles).
7. Check the brake operation BEFORE entering or traveling on a busy highway.
8. Always block the trailer wheels solidly before unhitching.
9. Before leaving a camp area with a trailer in tow, insure:
 - a. The safety pin or locking lever is seated.
 - b. The breakaway wire is attached to the tow vehicle.
 - c. All jacks are raised so that they cannot touch the ground.
 - d. The 110-volt electrical cord is properly stored.
 - e. The safety chains are connected.
 - f. All interior lights are off.
10. Observe and obey the warning labels attached to your vehicle concerning propane, water, electricity and loading.
11. Extinguish all campfires before leaving your campsite.

EXTENDED OR COLD WEATHER

Your KZ recreational vehicle has been built for enjoyment in a recreational manner. This recreational vehicle is not intended to be used as full time living quarters. Nor is this a four season unit. Using this unit in freezing conditions is not recommended. However, if unit is used in freezing weather, following are guidelines to follow. Any problems resulting from freezing are not covered under warranty.

1. For winter use in freezing conditions, more protection may be required. Use skirting and/or insulation below floor level to provide additional protection.
2. Remember water freezes at 32 degree Fahrenheit whether fresh or drainage. Proper care must be used to protect any system at 32 degree F or lower. Local recreational vehicle dealers and campground personnel may be able to advise you on needed protection.
3. Energy requirements, such as propane and electrical supplies must be adequate. Protect your propane regulator from freeze ups.
4. During cold weather you will experience more condensation then normal. Using ventilation or a dehumidifier may be needed.

CONDENSATION

Where it comes from, what causes it, and various solutions.

Causes:

- A. It occurs when warm moist air contacts a cold surface, such as rain touching a tent, awning fabric with people breathing warm moist air against it from inside due to normal breathing.
- B. When cooking food or taking a shower, warm moist air circulates throughout the coach attaching itself to cooler surfaces, forming beads and running down wall or window.
- C. Normal breathing will emit approximately 1/2 pint of moisture into the air per person, per day. The more occupants the greater quantity of condensation you may find.

Solutions:

1. When taking a shower, open bath roof vent approximately ½ inch allowing moisture to escape.
2. Use the power vent over range when cooking.
3. If condensation is found in cabinet or closets, open door slightly to equalize temperature and provide ventilation.
4. Opening windows and roof vents, when possible, allowing warm moist air to escape is the best way to reduce condensation.
5. Under extreme conditions, you may need to use a dehumidifier to remove moist air conditions.

In camping, coaches which have tents or fabric bunk areas, it is even more important to avoid condensation drops from roof area.

Uncontrolled condensation can cause dampness, mildew, etc., inside your recreational vehicle. Be sure to make strong efforts to control condensation.



CAUTION

Continuous living in your recreational vehicle could cause accelerated wear to components above recreational use.

INTERIOR VENTILATION

A new coach always has a peculiar aroma in it due to all the components used to build it, such as paneling, plywood, carpet and fabrics.

Allowing fresh air to move and circulate throughout a new recreational vehicle is very valuable for several reasons.

1. Components used to build RV's always have a "new" smell to them, possibly irritating the respiratory system of the human body on warm days.
2. Fresh air is always good for the human body unless allergies are a factor.

Numerous ways are provided to exchange air in coaches.

1. Open windows on non-rainy days, allowing air exchange between inside and outside.
2. Power hood vent above cooking stove will send heat and food smell outside.
3. Roof vent; numerous types;
 - A. Standard air flow using gravity flow method.
 - B. Power (12v or 110V) vents will move air faster.
 - C. Hi-volume power vents, operation in 12 volt power can exchange air in a coach in several minutes if windows are open accordingly. If there is a fan in the rear, open window(s) in front.

Different brands/models have different features, such as remote control, rain sensor, variable speed control switch, etc.

Read carefully the operating instructions as placed in your coach, provided by the manufacture of various components.

CHAPTER 2 SERVICE PROCEDURES

BASIC SERVICE PROCEDURES

Both KZRV and Your KZRV Dealer has a strong and dedicated interest in maintaining the highest quality customer relations with its owners. Your satisfaction with your KZ recreational vehicle and your KZRV dealer is our primary concern. By producing high quality products, we want to assure our customers of our support with parts and service availability. **Our dealer network is the first choice to serve and supply your needs for your recreational vehicle.** Our authorized dealers will pleasantly assist in providing service maintenance needs plus parts, options, and information concerning your recreational vehicle.

Should you experience a problem with service availability, please follow the steps in the order listed below.

1. Contact your selling dealer's service department for an appointment. Describe to the best of your knowledge the nature of the problem. Please keep appointments to establish a good, workable relationship.
2. Contact the owner or general manager of the dealership should the initial attempt fail with the service department.
3. Contact:
Customer Relations Department
KZRV
0985 N 900 W
Shipshewana, IN 46565

Phone: (866 472 5460)

E-mail: kz@kz-rv.com
Website: <http://www.kz-rv.com>

Give all the above information as requested along with the serial number of the coach in question. We will make every attempt to resolve your problem.

Please bear in mind that most problems arise from misunderstandings concerning warranty coverage and service. In most instances, you will be referred to the dealer level and your concerns will be resolved with the dealer's facilities and personnel.

Dealer

Your authorized KZRV dealer has performed a PDI (pre-delivery inspection) on your recreational vehicle. Since your dealer is authorized to sell KZRV products, they are also there to supply parts, optional equipment, and provide service repairs, warranty or otherwise as needed.

First choice for warranty repairs is your selling KZRV dealer. Other dealers can be used, however, prior approval is required.

Some recreational vehicle dealers may be authorized service centers for certain manufacturers of products warranted separately, such as appliances. Check with your dealer before contacting anyone else to reduce delays. If the dealer is not an authorized service center for the product in question, he can assist you in obtaining authorized service.

Factory

Service repairs can be performed at the manufacturing facility at Shipshewana, Indiana. Should your KZRV product be in need of major repairs and your dealer recommends factory repairs, please follow the steps listed below for such work.

1. Your dealer **must** make an appointment with service personnel at the factory PRIOR to your arrival.
2. Any freight costs are the responsibility of the owner as listed in the warranty coverage schedule.

Parts

Stocking of parts varies from dealer to dealer. Any authorized dealer can order any required part to be shipped to their dealership. All parts are obtained through authorized KZRV dealers only.

Owner's Responsibility

When owning and using a recreational vehicle, it is important to perform regular and normal maintenance. This is recommended twice a year, spring and fall, to prevent undesired deterioration of your coach. Weather elements play an important function on sealants and other components requiring normal maintenance.

As an owner and operator, it is your responsibility and obligation to inspect and return your coach to an authorized dealer for repairs as required. Your authorized selling dealer is always your first choice and he certainly has continued interest in your satisfaction. As your manufacturer, we recommend that inspection and service be performed by your selling dealership.

If you are traveling and are unable to locate an authorized KZ dealer, or an authorized dealer for the component needing service, please call our customer service office at (866-472-5460). Service at a non-authorized dealer MUST have prior authorization. You may be asked to return any mechanical parts that were replaced before reimbursement consideration is made. Unauthorized or improper repairs may void the warranty of that component. Always keep your owner's manual along with a copy of your warranty registration with you when traveling.

Season Site

When placing your unit on a camp site in the spring and returning it in the fall to your home, it's classed as a "seasonal site."

Performing repair work on such a site is not recommended for numerous reasons; available parts, tools, space, weather conditions, etc.

Any service repairs which require a service technician also require the unit to be taken to a service facility, preferably your selling dealer.

Warranty coverage does not include trip or service call costs for such a trip. It is the owners responsibility to provide for such costs.

TOWABLE LIMITED WARRANTY

Two Year Limited Warranty

SUMMARY OF WARRANTY: KZRV warrants the structure of every towable recreational vehicle or truck camper purchased from an authorized KZRV dealer to the first retail consumer for a period of two (2) years, to be free from substantial defects in materials and workmanship when used for its intended purpose. The warranty period begins on the date of purchase or the date the unit is first placed in service, whichever is earlier. For purposes of this Towable Limited Warranty ["TLW"], the term "structure" includes the interior and exterior sidewalls, floor, roof, and frame.

EXCLUSIONS FROM WARRANTY: Excluded from coverage under the TLW are: (1) items added, changed, or modified after the unit left the possession of KZRV; (2) units used for any commercial purpose; (3) units used for full-time residential use or more than occasional recreational use; (4) wear and tear caused by normal usage by the consumer, including but not limited to fading or discoloration of soft goods [e.g., tents, upholstery, drapes, carpet, vinyl, screens, cushions, and mattresses], fading or discoloration of exterior or fiberglass components, tears, punctures, soiling, mildew, mold, and the effects of moisture condensation inside the unit; (5) the effects of alteration, tampering, mishandling, neglect, abuse, misuse, weather, acts of nature, acts of God, or corrosive atmospheres that promote rusting, oxidation, or pitting; (6) minor imperfections that do not interfere or affect the suitability of the unit for its intended use; (7) the effects of consumer's or transferee's failure to perform normal and routine maintenance [e.g., inspections, lubrication, adjustments, tightening of screws and bolts, tightening of lug nuts and wheels, sealing, rotating, cleaning, or other damages resulting from failing to follow the maintenance schedule and procedures in the owners manual; (8) damages resulting from misalignment or adjustments to axles or spindles caused by improper maintenance, modification, loading, unloading, road hazards, road defects, off road travel, or tire failures; (9) damages caused by the negligent or intentional use or misuse of the unit by the consumer or transferee, including but not limited to occurrences while towing the unit; (10) claims made for alignment or adjustment of patio doors [Note: any unit with a patio door is not intended to be towed like a travel trailer, and must be permanently parked on a lot. If such a unit is towed this TLW is voided in regard to the patio door and the surrounding structures]; (11) loss or damage caused by a person or business as a result of transporting the unit after sale to the consumer, delivering the unit, or parking the unit; (12) loss or damage to the plumbing system caused by freezing; (13) claims for personal injuries of any type; (14) costs of transportation of the unit for repairs; and (15) components that are warranted separately by another manufacturer [the warranty provided by a component manufacturer is the sole responsibility of that manufacturer, and KZRV does not warrant those components. Please refer to the warranties issued by the component manufacturers for the terms and conditions of such warranties].

TO OBTAIN WARRANTY SERVICE: Warranty service may be performed only at KZRV, or at KZRV authorized dealers and service centers. Contact KZRV for a list of authorized dealers and service centers. **REPAIRS OR REPLACEMENTS BY**

UNAUTHORIZED DEALERS OR SERVICE CENTERS WILL VOID THIS TLW. If the consumer believes that a claimed defect is covered by this TLW, contact must be made with an authorized dealer or service center WITHIN THE WARRANTY PERIOD. Sufficient information must be given to attempt to resolve the claimed problem. Should KZRV determine that repair or replacement is appropriate, the consumer must deliver the unit to the dealer or service center as directed. Delivery shall occur no later than thirty (30) days after the authorization for repair or replacement. Do not deliver your unit to KZRV, an authorized dealer, or service center without prior authorization. All costs incurred by the consumer for transportation for warranty service shall be the sole responsibility of the consumer. The dealer or service center shall repair or replace any warranted defect within a reasonable time, but no later than ninety (90) days after delivery by the consumer. Should the unit not be repaired or replaced within said period of time, then the consumer must contact KZRV by CERTIFIED MAIL with a written description of the claimed warranted defect and the efforts to remedy it. FAILURE TO SO NOTIFY KZRV IN THIS REGARD SHALL RENDER THIS TLW VOID AS TO THE CLAIMED DEFECT. After receipt of such notice, KZRV shall repair or replace such warranted defect within a reasonable time, but not later than ninety (90) days after delivery by the consumer. The scheduling of warranty work at an authorized dealer or service center is not controlled by KZRV and delays may be experienced. KZRV is not responsible for loss of use of the unit, expenses for fuel, telephone, food, lodging, travel, loss of income or revenue, or loss of or damage to personal property.

DISCLAIMER AND LIMITATIONS OF WARRANTIES: NEITHER KZRV NOR ITS DEALERS SHALL BE LIABLE FOR INCIDENTAL, CONSEQUENTIAL, INDIRECT, SPECIAL, OR PUNITIVE DAMAGES OF ANY KIND OR ANY OTHER FINANCIAL LOSS ARISING OUT OF OR IN CONNECTION WITH THE SALE OR USE OF THIS PRODUCT, WHETHER BASED IN CONTRACT, TORT, STRICT LIABILITY, EQUITY, OR ANY OTHER THEORY, EVEN IF KZRV HAS BEEN ADVISED OF THE POSSIBILITY OF SUCH DAMAGES. KZRV'S ENTIRE LIABILITY SHALL BE LIMITED TO REPAIR OR REPLACEMENT, AT KZRV'S SOLE OPTION.

THE UNITED NATIONS CONVENTION ON CONTRACTS FOR THE INTERNATIONAL SALE OF GOODS IS HEREBY EXCLUDED IN ITS ENTIRETY FROM APPLICATION TO THIS TLW.

THIS TLW, AND THE REMEDIES HEREUNDER, ARE EXCLUSIVE AND IN LIEU OF ALL OTHER WARRANTIES, EXPRESS OR IMPLIED, INCLUDING WARRANTIES OF MERCHANTABILITY, FITNESS FOR A PARTICULAR PURPOSE, CORRESPONDENCE WITH DESCRIPTION, AND NON-INFRINGEMENT, ALL OF WHICH ARE EXPRESSLY DISCLAIMED BY KZRV. THIS TLW GIVES YOU SPECIFIC LEGAL RIGHTS AND YOU MAY ALSO HAVE OTHER RIGHTS THAT VARY DEPENDING ON LOCAL LAW. SOME STATES LIMIT OR PROHIBIT LIMITATIONS OF WARRANTIES, SO THE ABOVE MAY NOT APPLY TO YOU. YOU SHOULD CONSULT A COMPETENT ATTORNEY FOR LEGAL ADVICE.

MISCELLANEOUS: No repair or replacement effected shall cause any extension or renewal of the warranty period. KZRV may make parts and/or design changes from time to time without notice and repairs or replacements may be made with new or different parts. KZRV reserves the right to make changes in the design or material of its products without incurring any obligation to incorporate such changes in any product previously manufactured. At KZRV's, sole option, any dispute concerning any warranted defect may be resolved through mediation or arbitration. This TLW shall be governed by the laws of the State of Indiana, and any legal action shall be brought only in the Circuit or Superior Court of LaGrange County, Indiana.

WARRANTY REGISTRATION AND CONTACT INFORMATION: The warranty registrations for component parts should be completed and delivered in accordance with the instructions contained therein. The TLW registration must be completed and returned to KZRV within fifteen (15) days of delivery of the unit to the consumer. Failure to do so can void this TLW or cause delays in obtaining benefits. The TLW registration, and all inquiries, must be directed to: KZRV, L.P., Warranty Department, 0985 N 900W, Shipshewana, Indiana 46565, Telephone: (260) 768-4016.

I HEREBY ACKNOWLEDGE THAT I HAVE RECEIVED, READ, AND UNDERSTAND THIS TOWABLE LIMITED WARRANTY, AND THAT I HAVE INSPECTED THE UNIT AND FIND IT IN THE CONDITION REPRESENTED.

Date: _____
Purchaser

CHAPTER 3 USING YOUR RV

In this chapter you will find three areas of useful information to assist you with correct **equipment**, **traveling**, and finally, actually **using your recreational vehicle**.

EQUIPMENT

Tow Vehicle

Begin your camping experiences by obtaining a tow vehicle which will adequately transport your recreational vehicle to and from your chosen destinations. Your most important measuring tool is the GVWR, Gross Vehicle Weight Rating, to cross match the capability of your selected tow vehicle.

Most auto and truck manufactures provide trailer towing guides for their products, Ask your local automotive dealer for a copy or call the factory's direct lines for information. Many tow vehicles, including mini-vans, have special towing package options available for small travel trailers. Tow vehicles with long wheel bases perform better than those with short wheel bases.

A second factor is GCWR, Gross Combined Weight Rating, which refers to the total weight of the tow vehicle and any vehicle in tow as a "combined" weight. This information, supplied by the tow vehicle manufacturer, is related to the capability of the tow vehicle.

The condition of the suspension in your tow vehicle is also an important factor. Make sure your tow vehicle is in good operating condition and follow the factory recommended maintenance guidelines.



Hitches – Travel Trailer

After obtaining your tow vehicle, it is very important to choose, and have installed, a correct hitch system with weight distributing bars to accommodate your coach, if so required. This selection and installation should be done by a professional hitch service center, which may or may not be your selling dealer.

Weight distributing hitches apply leverage between the tow vehicle and trailer. This assists in equalizing the weight between vehicles,

resulting in both vehicles traveling level. The condition of the tow vehicle's suspension system will affect the towing performance capability of your equipment.

Optional sway controls are also helpful with travel towing, especially long and heavy tongue weight coaches.

 CAUTION
Trailers with tandem axles need to travel as level as possible, avoiding different weights on each axle plus handling conditions.
 CAUTION
Using an oversized or undersized hitch can cause damage to the frame of your travel trailer or tow vehicle.

Hitch Height Specifications – Travel Trailer

Due to axles being either straight or drop bars, the ball height will vary. To find the correct height for ball hitch, set your trailer on a flat surface in level position. Measure from the inside of the ball socket to the ground, approximately 18 to 22 inches as shown, for correct spacing. You may wish to add 1 to 2 inches to this amount to compensate for sag of suspension of the tow vehicle when hooked to tow vehicle.

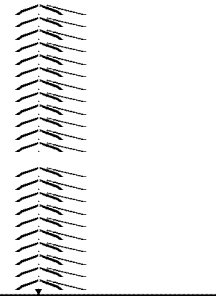

HOOK-UP (TRAVEL TRAILER)

Hooking up your travel trailer is not difficult and gets easier with practice. The following procedure will help you until you become more experienced.

1. To raise the tongue of trailer above the ball on hitch, turn the crank on the jack.
2. Open the coupler latch.
3. Back the tow vehicle into proper position, coupler over ball.
4. Turn crank on the jack to lower coupler onto the ball of hitch.

5. Close the coupler latch after completely seated, then insert a pin with a lock key or a lock.
6. Install weight distributing bars (equalizer), when required, as recommended by hitch supplier.
7. Retract the tongue jack to its maximum height.
8. Attach the cable for break a way switch to the tow vehicle.
9. Attach safety chains as per your state laws.
10. Attach seven way electrical connector from trailer to tow vehicle.

Below are listed numerous items that should be inspected and tested before traveling.

1. All lights working on outside of coach.
2. Stabilizer jacks in retracted position.
3. Steps in retracted position.
4. Refrigerator door latched completely.
5. Loose items in secure position.
6. Test brakes for operation before entering roadway.

HOOK-UP—FIFTH WHEELS

1. Place tow vehicle close to pin box.
2. Raise or lower front end of RV as needed.
3. Back tow vehicle against pin carefully.
4. Lower pin box until it touches hitch.
5. Release latch to lock pin to hitch plate. BE SURE it is locked to avoid a drop on tow vehicle.
6. Raise front landing jacks and adjust feet so they clear any objects.
7. Plug in your 12 volt, 7-way electrical cord from the tow vehicle to the trailer connector.

FRONT LANDING JACKS

Before unhooking your tow vehicle, several safety items to remember.

1. Be sure to park unit on solid ground.
2. Be sure tires are blocked and unit cannot move.
3. Be sure people and pets are away from camper.
4. Be sure to park on level ground, at all possible.
5. DO NOT lift the coach off the ground with landing jacks or stabilizer jacks.

Front landing jacks on fifth wheel campers are available in two different types. Mechanical gear driven jacks are operated with a

crank (manual) or optional 12-volt DC motor attached to gear box. Power is supplied by “on board” battery or tow vehicle while attached with 7-way connector. A switch is mounted to the front wall, spring loaded to raise or lower jacks. Don't forget to block the wheels, before you release the latch, raise pin box, and pull tow vehicle away. An in-line 30 amp fuse is located near the motor.

Now raise or lower front pin to level your unit as needed

CAUTION

Remember – always have the safety chain attached to tow vehicle, as required in your state.

Safety Chain (Travel Trailer)

Safety chain requirements will vary from state to state. The chain supplied with your coach meets SAE requirements for maximum gross trailer weight.

1. Cross the left chain under the coupler and attach to the right ring on hitch receiver of tow vehicle.
2. Now take right chain under the coupler and attach to left ring on hitch receiver of tow vehicle.

TRAVELING

Weights

For safety reasons and federal regulations, KZRV provides accurate weight specifications to owners. On the exterior left front corner of the coach you will find the Federal “Vehicle Identification Number” sticker, as required by the federal government. This tag supplies information concerning your coach, such as: VIN number, date/month of manufacture, tire size rating, plus information about weights as described on following page.

Gross Axle Weight Rating (GAWR) is the value specified as the load carrying capacity of a single axle system, as measured at the tire ground interface. Effective September 2017, the tires will be rated 10% higher than the axle, becoming the rating for GAWR.

MANUFACTURED/FABRIQUE KZRV.L.P. DATE
GVWR/PNBV; SHPSHEWANA,IN
GAWR/PNBE;
WHEEL/JANTE
COLD INFL. PRESS./ PRESS DE GCNFL.A FROID
THIS VEHICLE TO ALL APPLICABLE U.S. FEDERAL MOTOR
VEHICLE SAFETY STANDARDS IN EFFECT ON THE DATE OF
MANUFACTURE SHOWN ABOVE.

VIN/NIV NUMBER

Gross Vehicle Weight Rating (GVWR) is the maximum permissible weight on this trailer when fully loaded. It includes all weight at the trailer axle (s) and tongue, including ALL cargo, options and liquids.

Unloaded Vehicle Weight (UVW) is the weight of this trailer as manufactured at the factory. It includes all weight at the trailer axle (s) and tongue or pin. If applicable, it also includes full generator fluids, including fuel, engine oil and coolants.

Cargo Carrying Capacity (CCC) is equal to the GVWR minus each of the following: UVW, full fresh (potable) water weight (including water heater, and full propane weight.

WEIGHING VEHICLE (Loaded or unloaded)

The proper method to weigh the coach is to use a truck scale. Place coach axles (tires) and tongue jack 12" to 24" from the edge. Unhook the tow vehicle and move forward 6" to 8". Now record total weight. Re-hook the tow vehicle and remove the weight from the front support. Be sure no part of tow vehicle is on the scale. Now record the axle weight only. The difference between the two weights is the hitch weight.

KZRV suggests you also weigh each side (2 tires) separate to find balance of pounds per side. Its possible to have 1 side correct and the other side over-loaded. Often the slide out side or refrigerator will be slightly heavier than the other side.

The second sticker is about the allowed weight of cargo to be placed in your coach. Location of the sticker is on the inside of your coach, on the screen door, or inside of a cabinet door. It provides listed total allowable weight of cargo minus liquids allowed, water and propane.

RECREATIONAL VEHICLE TRAILER CARGO

VIN. _____

The weight of cargo should never exceed

Kg. _____ Lbs.

CAUTION

A load of water equals _____ kg. or _____ lbs. of cargo @
kg .or 8.3 lbs. per gallon.

Loading the Trailer—Distribution

Your recreational vehicle has been engineered to make maximum use of the available space for living and storage areas. The equipment and supplies you take along while traveling can be carried safely, provided the additional weight is distributed properly. Proper weight distribution within your trailer is an important factor in safety and efficiency of your trailer brakes, hitching, and how your tow vehicle will pull the trailer. DO NOT put excess weight in the trunk only. Excessive weight in the trunk area tends to develop sway and “fishtailing” of the trailer.

Lightweight and bulky items such as paper products, bedding, clothing, etc., should be stored in overhead cabinets and closets. Heavy items such as cooking utensils should be placed in lower cabinets. Canned goods need to be in a pantry, if so equipped, or in lower cabinets. Also, heavy items should be secured to avoid shifting during travel.

A reasonable principle in loading your coach is for every two pounds of weight loaded in front of the axle, one pound of weight must be loaded behind the axle. Also remember, improper side-to-side loading affects leaf spring weight allowance.

Excess weight behind the axle lightens the hitch weight and will tend to magnify any sway that may occur when passing trucks or when gusty winds are present. Uncalculated weight can and will effect road performance.

When using a weight distributing hitch and equalizer bars, you may move/transfer hitch weight from coach to tow vehicle assisting with level towing and easier travel.



CAUTION

DO NOT overload your unit. Please follow the GVWR when loading your recreational vehicle to avoid damages.

TOY HAULER—CARGO INFORMATION

All Sportsters are vehicles designed to transport your “toys” to camping area of your choice.

As in any Toy Hauler, care must be taken on how you load your cargo/equipment. When you place excessive or all of your allowed (NCC) Net Cargo Capacity, weight behind the axles, it could make your coach “tongue light”, causing sway, rear of tow vehicle “bouncy”.



CAUTION

Any damage caused by improper loading or installing additional equipment is NOT covered by KZRV Limited Warranty.

In all Toy Hauler rear area units, you may place 40% of (CCC) carrying cargo capacity in cargo area, and then distribute remaining pounds. Place 2 pounds in front of axle to every 1 pound behind axle, which includes the cargo in the cargo area. Some of this weight will be on top of axles.

Below is a blank space for you to calculate the “ Cargo Carry Capacity “ of your unit, based on this 40% formula. You will find the weights of your unit on a sticker, placed on the edge of the screen door. This will enable you to determine your “ Cargo Carry Capacity “ in the different areas of your unit also next page.

WARNING

Secure cargo and vehicles as far forward as possible. Excess weight in the rear of this trailer can result in loss of stability when towing.

Consult the trailer Owner's Manual for loading and weighing procedures. Keep the loaded tongue weight between 10% and 15% of total weight for travel trailers, and between 20% and 25% of total weight for 5th wheels.

Move cargo and/or vehicles to maintain proper balance. Do not exceed GVWR (total weight rating) or GAWRs (axle weight ratings) of the trailer or tow vehicle.

AD-115

When loading heavy cargo/contents into the storage area, you **MUST** have the stabilizer jacks in down position for any vehicle movement for support.

Any cargo in rear area, **MUST BE** secured behind axles, during movement of unit. For this reason, D Rings are installed on the floor of the cargo room.

Any two wheel items such as bicycles or motorcycles, will require additional support for the front wheel, such as a "wheel chock". Any such stabilizer item such as a wheel chock, should be installed per manufacture instructions.

Larger coaches may have a wall built between cargo area and camper area with door to open and close, cargo area with wall will be sealed to prevent fuel vapors to enter front space.



CAUTION

The tie downs (D-Rings) provided are for general purpose use, rating 1,500 lbs. each.

The transportation of certain types of cargo (motorcycles, bikes, etc.), will require additional accessories for secure transport. Please refer to owners manuals of these accessories or contact the manufactures of these specific items for more information.

Interior, Cargo Area

With internal combustion engines stored inside of cargo area, your living space has restricted use. Fumes from gasoline in engines are hazardous to the respiratory system in humans and pets. After removing vehicles containing gasoline fumes, ventilation is required before occupying the recreation vehicle. Two vents are located, one on each side, MUST be open at least 2 hours before occupying your camper. Opening windows will also help.

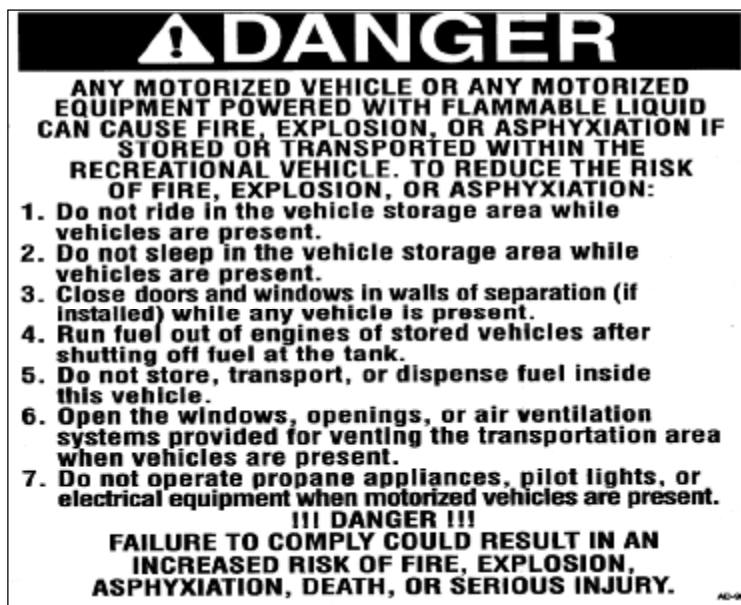

SLEEPING OPTIONS

1. Jiffy sofa/beds will be in certain floorplans, attached to wall and folded up, secured to wall for travel thus allowing cargo to be placed in center of floor.

2. POWER BEDS; (OPTIONAL) A bed assembly is available for the cargo area, attached to sidewalls with 4 posts anchored to sidewalls. Both double and single beds are available with foam mattresses. Bed assembly can be raised or lowered as desired through a 12 volt DC motor and power source. Switch is located in sidewall and fused, 15 amp in distribution panel.

Weight rating on power bed is 600 pounds, static (stationary) and 450 pounds dynamic (moving).

The available options (1) One bed with 1 matt, (2) Two beds with 2 mattes. (3) Sit N Sleep option is a set of dinette cushions attached to special frame, mounted onto the power bed. Center part will flip over and become back seat for a dinette. *In bed position all four cushions form into a bed.*

Rear Screen Door (Optional)

A full pull down screen door is available to prevent insects from entering and can be installed at a later time. It operates much like a garage door, manually up or down as you choose. With screen door you may leave large outer door open and have fresh air while avoiding vermin and insects.

Rear Cargo Door

Rear door on Toy Hauler is "spring loaded", also known as having preset and designed springs attached along with hinge assembly at the bottom of the door. As you lift up or down these springs support most of the weight. Size and quantity of springs determine amount of weight they support. Springs are NOT adjustable. Door also serves as ramp. A latch on each side ensures tightness when closed. Handle will latch into lock when closed. Lock may be secured with key.

Fuel Cell (Option)

The fuel cell system was developed for each owner to carry gasoline in a tank or tanks installed under the frame between two special cross members welded to the frame. The tank is attached with three cross bars bolted to the frame members with grade # 5 bolts and nuts. Fuel in the single tank will supply gasoline for any toys having a gasoline motor. Rear tank will have a pump, hose, and discharge nozzle. Hose and nozzle will be in a caged compartment, under the floor and attached to main rail of frame. Front tank (if equipped) is for generator.

Power for the pump is supplied by a 12 volt battery, or convertor when 120 AC power is available. It is fused through the 12 volt panel in the load center.

Switch for pump is inside of a 4" by 6" compartment in front or just behind gas fill, located on sidewall. Gauge for tank is also in this compartment. Switch must be ON" to register quantity of gasoline

All required hoses, along with vents are installed. Place nozzle into tank and squeeze handle to release fuel into desired container.

WARNING: The nozzle DOES NOT have a “automatic shut-off” on it.



DO NOT fill over 90% of tank total volume.

OPERATING pump for more than 5 minutes with nozzle closed will reduce motor and pump life.

GENERATOR

With generator or generator prep you will have the second tank along with a "Vapor control center" plus hoses mounted on either side of tank. All lines must be hooked up for complete installation and operation.



NO SMOKING
BEFORE DISPENSING FUEL, TURN OFF ALL ENGINES, FUEL
BURNING APPLIANCES AND THEIR IGNITORS.

DO NOT DISPENSE FUEL WITHIN 20 FEET OF AN IGNITION
SOURCE.
FAILURE TO COMPLY COULD RESULT IN FIRE, DEATH, AND
SERIOUS INJURY

TIRES

All KZRV towable coaches are equipped with correct rated tires for recreational vehicles. Tires are rated to carry weight as listed on G.V.W.R. specifications. Tires are radial in design built with components to offer excellent strength and mileage in all kinds of weather conditions.

Tires on your vehicle(s) are one of the most important components of the towing package. Without inflated tires you will not be moving anywhere.



CAUTION

It is recommended that the tire pressure be checked at the beginning of each journey, and at least once per week to obtain the maximum life of the tires.

Taking care of your tires during travel is very important. Top of the list is maintaining correct air pressure and secondly is NOT over loading your R.V, With proper care, the performance of fuel economy and handling on the road will be better. Safety on the road is very important in avoiding road hazards which can damage your tires plus obeying the speed limits.

On left front, exterior corner of your coach, you will find the (VIN) label along with a placard supplying information on tires such as tire size and amount of air pressure (maximum) .

TIRE PNEU	SIZE DIMENSIONS	COLD TIRE PRESSURE PRESSIONDES PNEUS A FROID
FRONT AVANT		
REAR ARRIERE		
SPARE DESECOURS		

Both placards and certification labels are permanently attached to the trailer on the left front corner of exterior and easily readable from

the outside of the vehicle without removing any covers. Due to weather elements, labels may fade over time. You may wish to record this information and keep it inside of the coach, perhaps with your owner's manual.

Understanding Tire Pressure and Load Limits

Tire inflation pressure is the level of air in the tire that provides it with load-carrying capacity and affects the overall performance of the vehicle. The tire inflation pressure is a number that indicates the amount of air pressure—measured in pounds per square inch (psi) - a tire requires to be properly inflated. (You will also find this number on the vehicle information placard expressed in kilopascals (kPa), which is the metric measure used internationally.)

The listed amount is for maximum load capacity. When traveling with less than full weight, you may wish to reduce air pressure for smoother ride.

While driving your tires will get warmer, causing air pressure to increase. To get an accurate pressure reading, you must allow tires to cool for three hours

For convenience, purchase a tire pressure gauge to keep in your vehicle. Gauges can be purchased at tire dealerships, auto supply stores, and other retail outlets.

The recommended tire inflation pressure that vehicle manufacturers provide reflects the proper psi when a tire is cold. The term cold does not relate to the outside temperature. Rather, a cold tire is one that has not been driven on for at least three hours.

If you have been driving your vehicle and think that a tire is under inflated, fill it to the recommended cold inflation pressure indicated on your vehicle's tire information placard or certification label. While your tire may still be slightly under inflated due to the extra pounds of pressure in the warm tire, it is safer to drive with air pressure that is slightly lower than the vehicle manufacturer's recommended cold inflation pressure than to drive with a significantly under inflated tire. Since this is a temporary fix, don't forget to recheck and adjust the tire's pressure when you can obtain a cold reading.

Tire Size

To maintain tire safety, purchase new tires that are the same size as the vehicle's original tires or another size recommended by the manufacturer. Look at the tire information placards, or the sidewall

of the tire you are replacing to find this information. If you have any doubt about the correct size to choose, consult with the tire dealer.

Tire Tread

The tire tread provides the gripping action and traction that prevent your vehicle from slipping or sliding, especially when the road is wet or icy. In general, tires are not safe and should be replaced when the tread is worn down to 1/16 of an inch. Tires have built-in tread wear indicators that let you know when it is time to replace your tires. These indicators are raised sections spaced intermittently in the bottom of the tread grooves. When they appear “even” with the outside of the tread, it is time to replace your tires.

Tire Balance and Wheel Alignment

Tires are not balanced on your unit, nor is it required. You may choose to balance the tires on your unit, however this will not be covered under warranty.

Wheel alignments may be needed periodically due to road hazards, such as pot holes, etc. This also is not covered under warranty, due to being a uncontrollable element. Wheel alignments, will assist with getting the maximum life from your tires. Alignments require special equipment, and should be performed by a trained technician.

Tire Repair

Most tires can be repaired from punctures, depending on size and location. More information on repairing tires may be found in maintenance manual,

Tire Fundamentals

Federal law requires tire manufacturers to place standardized information on the sidewall of all tires. This information identifies and describes the fundamental characteristics of the tire and also provides a tire identification number for safety standard certification and in case of a recall.

Considerable quantity of information is built in to the sidewall of tire, such as: date of manufacture, size, weight limit tire can carry, air pressure, serial number, which production plant tire was built in.

The letters “ST” refer as “service tires” used on most Recreational Vehicles, manufactured for that very purpose.

TIRE SPEED RATING —Each original tire installed on KZRV recreational vehicles has a speed rating of 75 MPH or greater. Please note maximum load rating, tire pressure and speed rating as printed on the sidewall of tire.

Beginning in 2017 model year, tires will have NITROGEN in them in stead of air. The green caps on tire stems indicate contents are nitrogen.

VEHICLE LOAD LIMITS

Determining the load limits of a vehicle includes more than understanding the load limits of tires alone.

On a travel trailer, there is a Federal Certification label that is located on the left front of sidewall on unit.

This label will include the gross vehicle weight rating (GVWR), the most weight when fully loaded, allowed on vehicle 's chassis. It will also provide the gross axle weight rating (GAWR), the most weight allowed per axle and tires.

In the same location described above is a placard showing tire and loading information including maximum cargo capacity.

CARGO CAPACITIES

Cargo can be added to the vehicle, up to the maximum weight specified on the placard. The combined weight of the cargo is provided as a single number. In any case, the total weight of a fully loaded vehicle can not exceed the stated GVWR.

Water and propane also need to be considered. The weight of fully filled propane containers is considered part of the weight of the RV before it is loaded with cargo, not part of disposable cargo. Water however, is cargo weight to be disposed. Remember water weigh' s 8 pounds per gallon. Reducing water quantity allows more cargo pounds. Understanding this fact helps make choices to fit your travel and camping needs.

When loading your cargo, be sure it is distributed evenly to prevent overloading front to back and side to side. Heavy items should be placed low and as close to the axle positions as reasonable. Too many items on one side may overload a tire. The best way to know the actual weight of the vehicle is to weigh it at a public scale. Talk

to your RV dealer to discuss the weighing methods needed to capture the various weights related to the RV. This would include weights for the following: axles, wheels, hitch, and total weight.

How Overloading Affects Your RV and Tires.

The results of overloading can have serious consequences for passenger safety. Too much weight on your vehicle's suspension system can cause spring, shock absorber, or brake failure, handling or steering problems, irregular tire wear, tire failure or other damage.

An overloaded vehicle is hard to drive and hard to stop. In cases of serious overloading, brakes can fail completely, particularly on steep hills. The load a tire will carry safely is a combination of the size of tire, its load range, and corresponding inflation pressure.

Excessive loads and/or under inflation cause tire overloading and, as a result, abnormal tire flexing occurs. This situation can generate an excessive amount of heat within the tire. Excessive heat may lead to tire failure.

It is the air pressure that enables a tire to support the load, so proper inflation is critical. Since RVs can be configured and loaded in many ways, air pressures must be determined from actual loads (determined by weighing) and taken from the load and inflation tables provided by the tire manufacturer. These air pressures may differ from those found on the certification label. However, they should never exceed the tire limitation for load or air pressure. If you discover that your tires cannot support the actual weights, the weight of load will need to be reduced.

Note: Tires are warranted by the manufacturer of their respective brand and are to be serviced and warranted by a service center. Contact your dealer for information on service centers for tires.

How to Change a Tire

1. Place blocking under main rail of frame with hydraulic jack on top of blocking in front of front spring hanger, ALWAYS on main rail.
2. Break lug nuts loose before raising coach .DO NOT remove nuts.
3. Raise coach with jack until wheel is off the ground.
4. Place additional blocking under frame for security support. DO NOT depend fully on jack.
5. Be sure coach is solid and will not move with tire and wheel off.
6. Remove lug nuts when tire is off the ground.

7. Install spare tire and wheel onto hub.
8. Reinstall lug nuts and tighten firmly.
9. Drop tire and wheel onto ground after removing supports.
10. Now fully tighten and torque lug nuts at 90 to 120 foot pounds.
11. Place all equipment into coach or tow vehicle, blocking and jack.
12. Re-torque wheel after traveling 100 miles.

WHEEL BEARINGS

All wheel bearings are pre-lubricated during assembly of axle and brakes. Your coach may have 'ULTRA LUBE' method of having a grease fitting in the end of axle. Remove rubber cap on end of axle and use standard grease gun to place grease into bearings, 6 to 8 shots. Don't forget to repack bearings as per maintenance manual upon return home. Grease in your gun is not true wheel bearing grease.

Wheel Lugs

When the wheels are installed on your recreational vehicle, the lug nuts must be tightened at 90-120 foot pounds of torque. Powder coat painted wheels may require more torque attempts due to thickness of paint. You must re-torque the wheel lugs at 50 and 200 miles. A decal on the wheel may require torque earlier.

After your first trip, check the wheel lugs periodically for safety. The wheel lugs should then be checked after winter storage, before starting a trip or following extensive braking. The size of bolts or nuts is 13/16 inch standard and 3/4 inch for chrome nut. **Over torque will damage components especially if wheel lug torque goes over 150 pounds. Normally the "nut" fails first however the embossing on the wheel can also be flattened, and then fail to keep the wheel tight.**

Brakes—Electrical

Electric brakes on your recreational vehicle are designed to work in conjunction with the hydraulic brakes on your tow vehicle. This means to have the best brake performance on both systems, the trailer and the tow vehicle must perform and operate together. Any attempt to use either brake system alone, tow vehicle or trailer will cause accelerated wear and damage.

A brake control is required to operate brake system, which is mounted under dash of tow vehicle, using 12 volt D.C. power. Electronic type is used most widely. Each brand has their own operating instruction

Battery in the tow vehicle is your primary source to operate the brake system in towable trailer. Keep battery and charging system in good working condition to ensure available energy when needed.

Power from battery is sent to the controller, the switch to provide the correct amount of current to brake assemblies on the coach. As you press harder on the brake pedal, more current will flow, applying brakes more, increasing braking capability.

Wiring to operate your brakes must be sized correctly in both vehicles, suggesting a minimum of 14 gauge from front end to brake assemblies. Wiring is done parallel, never in series. Being parallel, there will be equal voltage at each brake assembly for equal braking capability and performance.

Use the foot pedal control for general operation on combined use of both brake systems. Manual control is to be used only in special situations, such as slow movement or icy road conditions. In open position, electrical current will flow to brake assemblies activating them.

When applying brakes to stop trailer, begin pressing slowly to avoid quick and sudden stops, or possible "jack-knife" WHEN SLIPPERY OR WET. Use lower gear ranges to minimize the need of brakes during extended or steep downgrades.

Your coach has self-adjusting brake assemblies that will correct any looseness in operation as they will adjust in forward or backward motion as soon as pulling begins.

Breakaway Switch

The breakaway switch is a safety part of your trailer's electric brake system. The very instant a breakaway occurs, the pull pin which is attached to the tow vehicle is pulled apart from the switch. The two contacts automatically close sending 12 volt D.C. power to brake assemblies activating brake shoes to stop trailer. A 12 volt battery must be installed on trailer to power break-a-way switch

NEVER use this breakaway switch and trailer brake system as a parking brake. There would be a high amp draw on battery and convertor, potentially causing damaged wiring, connectors, and breakaway switch plus unnecessary energy draw. When plunger is pulled there is a constant 12 volt draw on energy source to the brake assemblies.

CAUTION; Removing plunger with power to brakes could result in damage to brakes.

WARNING; Removing plunger while in storage could result in corrosion of unit points.

WARNING; A tag may be attached to the lanyard cable, DO NOT use as a parking brake.

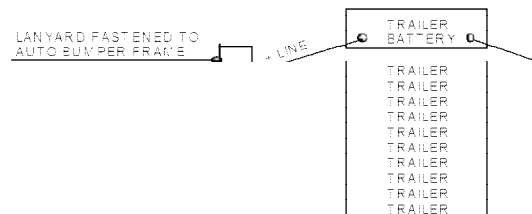

**SAFETY BREAK-AWAY SWITCH
WILL NOT OPERATE**
Unless connected to a power source
equivalent to or greater than an auto
-motive type 12 volt, 12 amp hour
wet-cell battery.

TOWING

In towing your trailer, you need to recognize the extra weight behind your vehicle. Below is a list of observations you need to remember while traveling.

1. With the trailer attached, you will have slower acceleration and will require more distance to stop.
2. Be sure you have enough area at corners when turning, as wider turns are necessary. Be sure to use your turn signals for your own safety and the safety of others.
3. In passing or changing lanes remember you will need a longer distance to pass.
4. Use your rear view mirror frequently to observe your trailer and traffic conditions.
5. When being passed by a large truck or bus, be prepared for displaced air as it may cause you to sway slightly, especially travel trailers.

6. When climbing steep, long grades and again while descending, use lower gears even before it seems necessary. Use your brakes smoothly and evenly.

7. Remember to drive more slowly on wet and icy highways to keep control of your vehicle.

SETTING UP AND USING YOUR RECREATIONAL VEHICLE

KZRV recommends that you select a level or nearly level place for camping. There are two reasons to be level. First, all components in your coach, such as your water drainage system and especially your refrigerator, are designed to operate in a level position. Second, it is more comfortable to live on the level. Should a level site not be available, use short 2 x 6 inch blocks of wood to raise the low side wheels to a level position.

Before unhooking the trailer from the tow vehicle, be sure the jack foot is in place on the tongue jack and block the trailer wheels to keep the trailer from moving.

Before lowering the tongue jack, you may wish to place a wood block or hard support under the foot of the jack, unless you are on a cement slab. This helps to prevent the jack from sinking into the dirt.

Travel Trailer— Unhooking

1. Release the weight distributing bars (if used).
2. Unlock or remove safety pin from coupler latch, then release the safety latch on the coupler.
3. Raise the coupler on the A-frame by turning the tongue jack until the ball is free.
4. Disconnect the 7-way wire connector, safety chains, and the breakaway cable.
5. Raise front jack until tow vehicle will clear coach. Drive tow vehicle away.
6. Now raise/lower front end until coach is level.
7. Lower stabilizer jacks to desired position to stabilize coach.
8. Reverse procedure to hook up coach to tow vehicle.

The use of stabilizer jacks on a recreational vehicle is a popular and useful option. They provide a reasonable amount of stability while using, occupying, and moving around in your camper. It is important to remember that stabilizer jacks are for support of the coach and are not designed to bear the weight of a recreational vehicle.

To operate the stabilizer jack, place crank onto the jack shaft and turn clockwise to lower until the frame begins to raise slightly. Equalize all four jacks for best support. You may need to adjust each jack two or three times. Each stabilizer jack has a weight rating, of 1500 pounds or more.

To raise jack to upper travel position, insert crank and turn counterclockwise until jack is seated in UP travel position.

Upon completing the setup of your coach, you are now ready to make attachments to various facilities:

- ✓ Waste water hose connections.
- ✓ 110-Volt power cord electrical hookup.
- ✓ Turn on propane tanks and light the pilot lights, if any, on appliances. Remember there may be air in your propane lines. Be sure to bleed them before planned usage.
- ✓ Open any windows and roof vents as desired for ventilation.
- ✓ Fresh water connections.

You may have additional accessories and options, such as an awning on the door side which need to be opened. Separate instructions are provided by the manufacturer of these components.



GENERAL DETECTOR Information

As you are confined in a RV which is much smaller than a standard house, you must realize safety detectors will be activated much sooner than in a residential house, due to there being less air and oxygen volume.

Each of these detectors have their own manual and instructions, providing additional information for it's care and operation.

Life time of each detector is up to 10 years and will need to be replaced as per manufacture's instructions. Record purchase date on the detector.

SAFETY DETECTORS—3

FIRE EXTINGUISHER—#1

A fire extinguisher is installed in each vehicle and is located near the entrance door in the RV. Be familiar with its location and operating instructions as printed on the extinguisher. Inspect your extinguisher at least two times per year or more often, as instructed on the extinguisher. Extinguisher is rated at 5 or 10 B.C.

PROPANE/CARBON MONOXIDE DETECTOR—#2

Any recreational vehicle which contains a propane fuel system with propane consuming appliances requires a propane leak detection device for safety protection. Currently this detector also serves as a carbon monoxide detector, as a combination protection device. A converter or auxiliary battery is required to supply 12-volt DC energy to operate the detector. There is no master cut-off switch or in-line fuse to disengage detector, only 15 amp fuse in fuse panel.

What Is Carbon Monoxide?

Carbon Monoxide (CO) is a highly poisonous gas which is released when fuels are burnt. It is invisible, has no smell and is therefore very difficult to detect with the human senses. Under normal conditions, in a room where fuel burning appliances are well maintained and correctly ventilated, the amount of carbon monoxide released into the room by appliances is not dangerous. Fuels which emit CO are wood, coal, charcoal, oil and petroleum products, which MUST have exhaust vents. Such gases can build up in the blood, interfering with the body's ability to supply oxygen to itself.

Because CO is a colorless, odorless, tasteless, and highly poisonous gas that prevents the blood from carrying oxygen to vital organs, CO is 200 times more likely to replace oxygen in the blood. It can endanger lives even at low levels of concentration.

DUAL SENSOR TECHNOLOGY

The SAFE-T-ALERT series combination CO/Propane Gas Alarm is an alarm that combines into a single, compact system a powerful alarm that detects both Carbon Monoxide (CO) and explosive gases propane (LPG).

The 35 series uses the latest microprocessor technology combined with two electronic self-cleaning sensors that operate independently

of each other. The combined unit can detect CO and explosive gases simultaneously.

Operation

When the unit is first powered up, the CO sensor requires a ten (10) minute initial warm-up period to clean the sensor element and achieve stabilization. The GREEN LED indicator will flash on and off during the 10 minute warm-up period. The unit cannot go into a CO alarm during the warm-up period. To test your unit during the warm-up period, press the test button. See Test Procedure in this manual. After the warm-up period, the GREEN power ON indicator should glow continuously if the ON indicator light does not light, see the section, **Trouble-Shooting Guide**, in manual supplied by manufacture of detector.

Gas Alarm: When you power the alarm, it has a warm-up period of approximately 1 minute. This unit cannot go into a gas alarm during the warm-up period. After 1 minute the alarm can detect explosive gas and will energize the relay on models 35-742-R and 35-742-R-MS.

Simultaneous CO and Gas Alarms Because the risk of a propane gas explosion is generally a more serious danger, your alarm unit gives the gas alarm a higher priority during simultaneous alarm condition.

If your unit generates alarms for both Gas and CO at the same time, the gas LED will flash red and the beeper will sound. The CO LED will be a solid Red until the CO is ventilated out of the RV, at which time the LED will return to the Green operational/safe color.

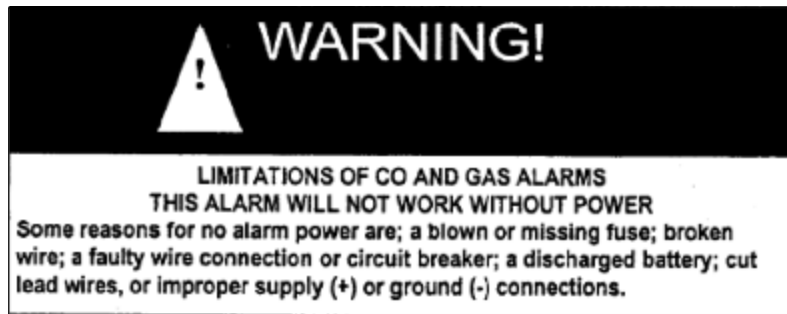

Brownout Protection— The unit can tolerate short power interruptions and brownouts where the circuit voltage drops as low as 1 VDC. If the brownout lasts too long, the unit will reset and operate as described above.

Low Power Operation

This alarm will operate normally down to 7 VDC. Do not operate this alarm below 7 VDC.

Visual and Audible Alarm Signals

This SAFE-T-ALERT™ CO/Propane Gas Alarm is designed to be easy-to-operate. The alarm has two indicator lights that display a specific color for each monitored condition. There also is a matching sound pattern for alarm conditions.

CO Alarm

The Red CO LED will flash and the alarm will sound 4 “BEEPS” then be silent for 5 seconds. These signals indicates that the CO level is over 35 ppm. **IMMEDIATE ACTION IS REQUIRED.** See the **Procedures To Take During An Alarm** in the user’s manual that is supplied with the detector. This cycle will continue until the TEST/Mute button on the front of alarm is pressed. Ventilate the RV. The RED light will stay ON until the CO has cleared, or the alarm will reactivate in approximately 6 minutes if the CO is still present. DO NOT RE-ENTER THE RV. This alarm will return to normal operation after the RV’s properly ventilated.

Propane Gas Alarm

The RED LED will flash and the alarm will sound a steady tone whenever a dangerous level of propane or methane gas is detected. **IMMEDIATE ACTION IS REQUIRED.** See **Procedures To Take During A Gas Alarm.** The detector will continue to alarm until the Test/Mute switch on the front of the alarm is pressed. Ventilate the RV. The RED Gas LED will continue to flash until the gas has cleared, or the gas alarm will reactivate in approximately 5 minutes if the gas is still present. DO NOT RE-ENTER THE RV. This alarm will return to normal operation after the RV is properly ventilated.

MALFUNCTION/SERVICE SIGNAL. If any malfunction is detected, the Gas LED will remain off and the Operational/CO LED will alternate Red/Green and the alarm will sound once every 15 seconds. Press the Test/Mute button. If the Test/Mute button does not clear signals, check the battery voltage. **If the battery voltage is not low and the unit will not return to normal operation, immediately remove the alarm and return for service or warranty replacement.**

<u>OPERATION</u>	<u>AUDIBLE SIGNAL</u>	<u>VISUAL SIGNAL</u>
NORMAL	NONE	STEADY GREEN
CO ALARM	4"BEEPS" 5 SECONDS OFF	STEADY RED
PROPANE ALARM ALARM MALFUNCTION	CONSTANT "BEEP" EVERY 30 SECONDS	FLASHING RED ALTERNATING RED/GREEN
END OF LIFE	'BEEP EVERY 30 SECONDS	RED/RED GREEN/GREEN FLASHING

End of Life Signal—5 Years Service Life

All 35 series models include an End of Life (EOL) Signal indicating the sensor has reached the end of it's service life and you must replace the alarm. The signal is the LED flashing RED RED GREEN GREEN with a beep every 25-30 seconds. The EOL signal may be reset by pushing TEST/RESET button on the alarm. This will reset the EOL signal for a period of 72 hours for a total of UP TO 30 days. After 30 days the signal cannot be reset and the alarm must be replaced.

DO NOT DISCONNECT THE ALARM UNTIL YOU HAVE A REPLACEMENT ALARM AVAILABLE TO INSTALL.

SMOKE ALARM—#3

Smoke alarms are required when propane is used in coach and open flame cooking happens. Alarm is placed on ceiling between bed room and kitchen. Energy to operate is supplied by a 9 volt battery inside of alarm.

Operation: The smoke alarm is in operation once the battery is correctly connected. The LED will flash every minute to show the battery is supplying power to the alarm. When production of combustion are sensed, the unit sounds a loud alarm which continues until the air is cleared.

Testing: Test the smoke alarm by pushing the test button on the smoke alarm cover for at least three seconds, until the alarm sounds. The alarm sounds if all electronic circuitry, horn and battery are working. If no alarm sounds, the unit has a defective battery or other failure and should be replaced immediately.

- Test each smoke alarm weekly to be sure it is installed correctly and operation properly.
- Test smoke alarms after the recreational vehicle has been in storage, before each trip, and at least once per week during use.
- Stand at arm's length from the smoke alarm when testing. The alarm horn is loud to alert you to an emergency. The alarm horn may be harmful to your hearing.
- The test button accurately tests all functions. Never use an open flame from a match or lighter to test this smoke alarm. You may ignite and set fire to the smoke alarm and your home.

Life time of smoke alarm is 10 years, per manufacturer.

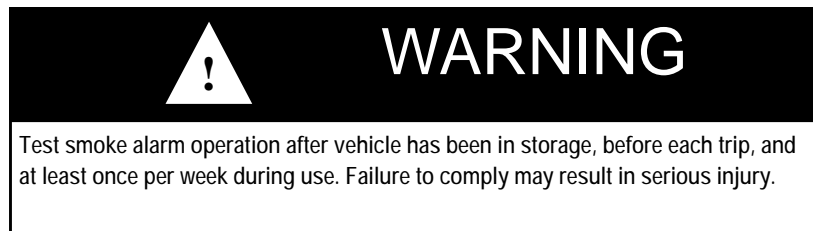

STEPS—1 TO 4

Type#1

Before entering your recreational vehicle place your hand in the center of the step assembly. Pull the center bar outwards. The step assembly will raise slightly and then out, away from the coach. The lower step will unfold 180° to useable position. The arm on the step will meet a positive stop. Step care, maintenance and lubrication will be found in the maintenance manual

Type#2

Looking at the entrance door, you will see no step. Open the door and step will be inside, attached to floor with 8-12 screws, standing upright.

With one hand, turn yellow or blue handle, hold step with other hand and slowly lower step to the ground, now using both hands. Adjust legs correctly to ground.

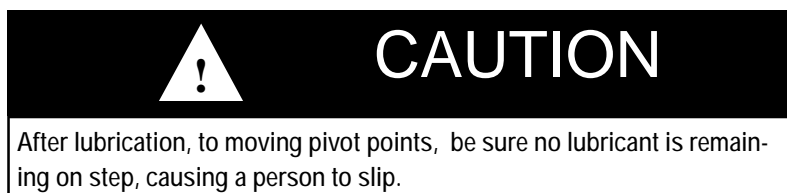

WINDOWS

All windows are of slider opening design, solid picture window (NON-OPENING), or egress. Sliders may open horizontal or vertical as called for per floor plan. Egress (Escape) windows have an unlocking handle or two small hinged clips on each side. After unlatching, the panel will swing out on a top hinge. The Egress (Escape) windows also have a screen that is attached to the swing out panel of window. Be sure these panels are latched correctly before traveling.

DOORS

Locks on entrance doors have two lock mechanisms, a deadbolt in the frame section of lock and a standard lock in the handle. Both locks use the same key.

Screen doors usually have a hook/lever type of latch. Pull lever downward to release door.

Locks on all doors need a small quantity of silicone lubricant sprayed internally two times per year to keep functioning correctly. All doors are keyed alike.

TV Antenna

The TV Antenna has a rigid base to mount the receiver head which cannot be rotated or raised up. Base is attached to the roof with 4 screws and the antenna is attached with 2 bolts and nuts.

Inside of coach, on the wall is a power supply with a brown cover where you hook-up to TV and Satellite. There is an on/off button on the power supply to engage the booster, located inside of the antenna head.

This antenna also serves as a radio receiver for the sound system in the coach.

Location of this power supply is:

1. On the wall, above the space for the TV, freestanding or wall mounted.
2. Behind the TV.
3. Possibly on the ceiling close to TV location.

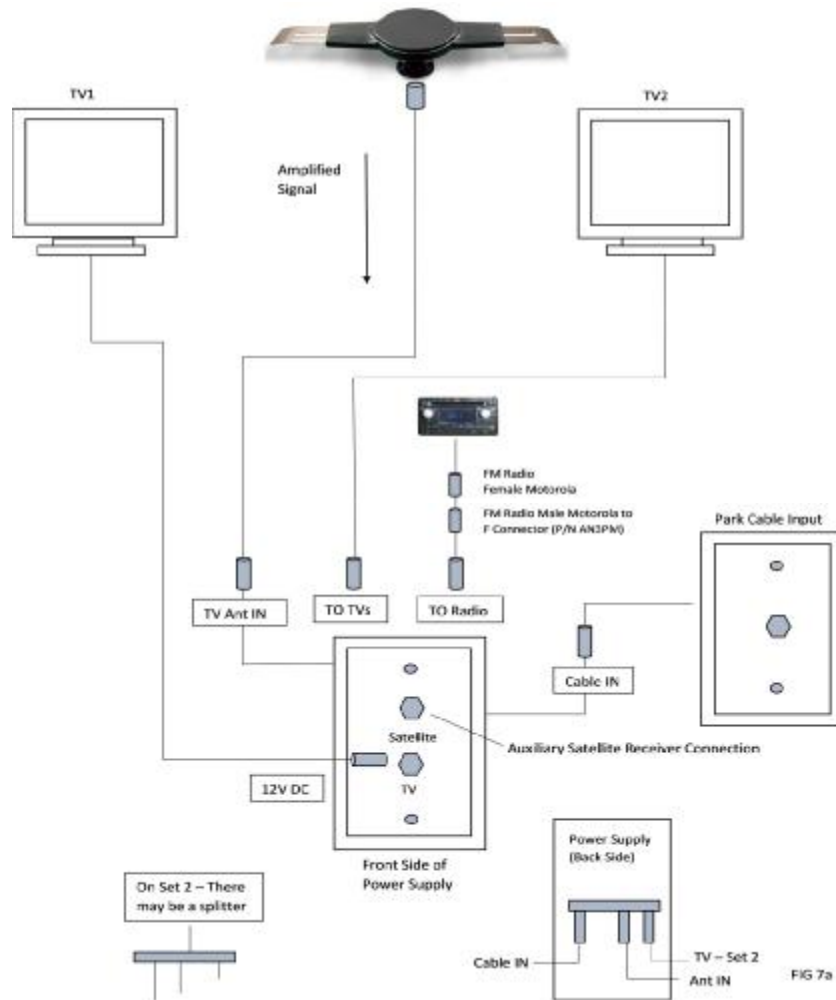

SLIDE-OUTS

With many models of trailers, KZRV builds numerous types of slide out systems as listed on following page, followed by descriptions. Several different vendors supply components, loose and/or attached to the frames.

1. Below frame system—All metal components are external, located under floor and in frame, inside of enclosed underbelly cover except the rams moving in and out.
2. Above floor system—All components are inside and above floor, to be found under dinette or sofa slide out.

3. Bedroom slides may be Lo—Profile or Schwintec including closet and wardrobe slides.

Before operating the power slide-out system in your coach, read and become familiar with these instructions, along with components and operation methods. Most of these components are inside of the enclosed underbelly cover and can't be seen.

Power For Operation

All power slide systems operate on 12 volt DC power provided by a fully charged auxiliary battery and converter. A 12 volt distribution load center with automatic 20 or 30 amp breakers provides power for each slide. For best performance, have 120 volt AC power attached to your coach, feeding the distribution load center. Tow vehicle 12V power may also be used as required.

Supplement your battery by either one of two choices

1. Hook up a 120 volt AC power cord to recreational vehicle for convertor option.
2. Use 12 volt power through the tow vehicle to the recreational vehicle battery or batteries.

Either of these methods will help ensure maximum electrical power for the slide-out motor, as well as maintain your battery



CAUTION

Because operating the slide-out draws up to 15 amp current from the battery, some source of supplemental charging should be operating while extending or retracting the slide-out.

TRAILER SET-UP Requirements—General

Note:

1. Before operating the slide-out room, level the trailer front to rear and side to side.
2. Extend all stabilizer jacks to make solid contact with the ground and/or on solid blocks. Placing stabilizer jacks onto a hard surface allows the coach to remain square and assure a good weather tight seal between the room and trailer sidewall.



DANGER

- ◆ Always make sure that the trailer is level before operating the slide-out room.
- ◆ Always make sure there are no obstructions blocking the path of the room when it is moving.
- ◆ Always make sure that the room path is clear of people and objects before operating.
- ◆ Always keep away from the slide rails under the coach when the room is in motion.

FAILURE TO FOLLOW THESE INSTRUCTIONS COULD RESULT IN SERIOUS INJURY OR DEATH.

Below Floor Slide System (BFS)

Mechanical Components

Under floor slide-out mechanism steel bars are welded to the frame members. A gear track is welded to bottom side of cross member, matching with a flat gear attached to drive shaft. Operation on both is identical. Attached to motor is a gear, meshed with track on ram, will move slide, in or out by 12 volt D.C. power. A cross shaft, from front to rear ram, connects the second ram moving the opposite end of slide. Mechanism operates the same, flush or standard floor.

Above Floor Slide-Out (AFS)

All components are located inside of coach, under dinette or sofa. Base is attached to floor and sidewall. Top portion has “cog” track attached to a “ram” which matches gear on motor. As motor runs, it moves the slide in or out, as you choose. On a large slide with 2 units, a cross shaft will connect both units, operated by one motor. Access to all these components are inside of coach, under sofa or dinette floor.

Open: Hold operation switch until room seals tightly on the exterior of the unit. DO NOT distort or bend the exterior flanges or interior fascia by holding the switch in the “ON” position.

Close: To retract, reverse the procedure and hold button until the room is fully inside with gaskets sealing to the outer wall. It takes about 20 seconds to move slide in or out.

KZRV does not require or suggest blocking, supports, jacks, etc. to be used under slide-outs during extended normal use. By using blocks or jacks, it will distort water sealing capabilities of seals.

Electrical Components

A 12 volt DC motor is located between main rails of frame on below floor system. On the above floor system, the motor will be under the floor of the sofa or dinette.

Operational Switch: This switch is a three position, (off in center, in or out) spring loaded switch. Select which direction you wish to move the room. Press on desired position and hold until room is seated, and gasket is slightly compressed. Do not force the room to move beyond sealing as damage could occur.

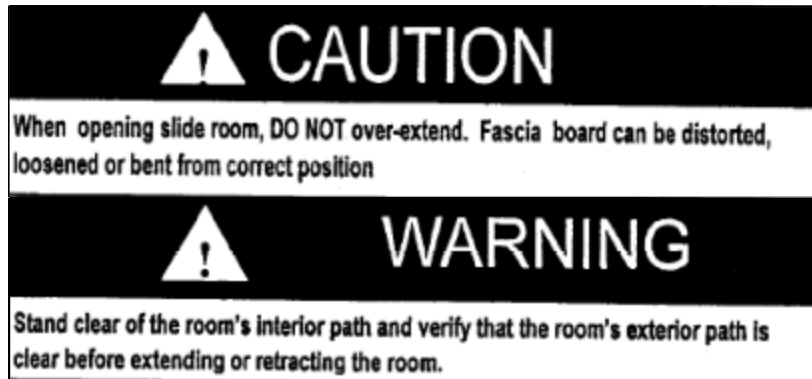

MANUAL OVERRIDE

Below Floor Slide Out

Should a power failure occur (no 120 volt AC power or the battery loses its charge), follow the listed direction. There is a 1/2" shaft coming through the main rail of the frame. On the end of the shaft is a 3/4" nut attached. Use a 3/4" socket, with an extension and ratchet to move the slide. On some units the stabilizer jack crank will also work on this shaft with the attached 3/4" nut.

Above Floor Slide Out

Should 12 volt power fail and there is no 120 volt AC power available, follow the listed direction. Access to the ram is under the floor of slide, of sofa or dinette, from the front. Lippert Component System has a smaller motor, less draw and requires a 5/8" socket, ratchet and probably an extension.

SCHWINTEC WALL SLIDE

Schwintec system is composed of four tracks placed on the outer sidewall of slide, two at the bottom and two near roof line. On each side an extrusion is attached to sidewall with a motor inside at the top. A gear mounted to motor will run on the upper track to move slide in or out. Wire harness is along side of extrusion.

Power is supplied by 12 volt D.C., convertor and/or auxiliary battery through a module board, located under the slide or near the slide in cabinet.

Operation error codes are listed and found in manual supplied by LCI, the manufacture of equipment, for circuit board and other components.

It is VERY important to keep tracks clean from dirt and debris.

Each side has it's own motor at top of extrusion, accessible only on the inside of coach.

MANUAL OVERRIDE

A. Electric manual over ride.

1. Locate the circuit board.—Identified on following page.
2. Press the "mode button six times quickly, press a 7th time and hold for approximately 5 seconds. The red and green LED lights will begin to flash, confirming the override mode.
3. Release mode button.
4. Back inside coach use the normal control switch to retract the room.

B. MANUALLY PUSH ROOM IN OR OUT.

1. Un plug both motors from circuit board. This releases the motor brake.
2. Push or pull slide room in as desired. Larger rooms may require several persons to push. Keep both sides even.

3. When room is completely in, plug both motors back into the circuit board to apply brake for road travel.
4. Room must be travel locked during travel time.



Module will be identified by:

“ Dual motor synchronous velocity slide controller”
Plus this # 13398—C2”

More information will be found in LCI. Manual.

BLINDS

Any blinds with loose cords, such as mini-blinds **CANNOT** be in stalled in bunks designed and built for young children. ALL shades **MUST** be in UP position for travel to avoid lower metal holder being in contact with garnish on window to avoid scratches.

	<h2>CAUTION</h2>
<p>While traveling all mini blinds need to be in the “UP” position to avoid swinging and scratching paneling, even with brackets installed on the bottom of window.</p>	
	<h2>WARNING</h2>
<p>These individual tassel cords reduce the strangulation hazard in the pull cord by removing the loop. Do not tie the cords together. Check periodically to make sure the cords have not twisted into a loop. This device will not prevent strangulation hazard if young children wrap pull cords around their necks. Always keep cords out of the reach of young children.</p>	

ENTERTAINMENT COMPONENTS

All radio's, TV's, CD's, DVD players, are purchased and provided with their own operating manuals, some are on CD and others with paper manuals. Read them carefully and completely before operating your equipment.



MURPHY BEDS

SUPERVISION—For your safety and the safety of others, please DO NOT allow any individual under the Murphy Bed when lowering or on the bed when it's being raised or stowed. Children should be supervised at all times and adults should likewise instruct children about the hazards of being under the bed when lowering or on the bed when it is being raised.



PINCH POINTS—Beware of pinch points between the base of the Murphy Bed and the sofa when lowering and between the base of the bed and the storage compartment when raising and/or stowing the bed. Also beware of the pinch point between the footboard and your feet when lowering the bed and the footboard and the base of the bed when raising to stow.



CRUSH HAZARD—Lowering the bed may cause injury to oneself or others. Keep clear of the bed base when lowering or raising the Murphy Bed and ensure that no child, adult or pet are under or near the bed when lowering or raising to stow.

USER ENTRAPMENT—Make certain that no person is on the Murphy Bed when it is being raised or if the bed has not been properly latched in place after it has been lowered for use. If the bed is not properly latched in place during use, it may inadvertently raise up if there is enough weight on the head of the bed past the pivot point. In that circumstance a person may be trapped between the bed and the storage compartment which may result in serious personal injury or death. In addition if someone is on the

bed when it is being raised to be stowed, that person may be trapped between the bed and the storage compartment which may result in serious personal injury or death.

MAXIMUM WEIGHT—Know your weight. Maximum capacity of the murphy bed is average sized adults. DO NOT exceed 500 pounds on the murphy bed.

MURPHY BED SETUP AND STOWING

1. This is a job for two people, one on each side of the murphy bed. Before lowering the Murphy Bed make certain that the sofa couch has been folded down and that no person is under the murphy bed area.
2. While holding the Murphy Bed with your free hand, pull back the barrel latch pins on both sides of the Murphy Bed locking the bed in the upright position. The bed should be unlocked and ready to be lowered.
3. Once the pins are unlatched, slide your hands underneath the footboard at the top of the Murphy Bed base on either side and slowly lower the bed to the horizontal position. The footboard will unfold at that time so beware of pinch points and the board hitting your feet. The bed should then rest on the foot board in a horizontal position.
4. There is a barrel latch on the side of the night stand. Locate it and make sure that Murphy Bed is latched in the horizontal position with that barrel latch before use. If it is not latched then there is a risk that the Murphy Bed may swing up into the upright position if a person places too much weight at the head of the bed.
5. When stowing the Murphy Bed please again make certain that two people do so and that no one or no object is on the bed or in the storage compartment.
6. Unlatch the bed and slowly raise it to the upright position in the storage set up position. Again, beware of pinch points and the footboard hitting your hands while the bed is being raised. While holding the base of the bed, latch the barrel latch pins on either side of the Murphy Bed. Make sure the bed is securely stowed before travel.

CHAPTER 4 SYSTEMS

WATER AND DRAINAGE PLUMBING

Your KZ recreational vehicle has a complete water system, to carry fresh water, as well as holding tanks for used water. Each group has its own explanation along with its own operation.

Fresh Water System

Tank

Water containers are installed under the coach between frame members and protected with a cover and a steel frame carrier, to be used when city water is not available. All water containers have 3 exit lines, (1) to draw water from tank to fill lines, (2) external spigot to drain tank, (3) over flow line.

Filling Fresh Water System —#1

To place water into your coach, use one of these methods. Different fresh water entry is used depending on floor plans.

1. Gravity Water Fill (figure 2): To place water into the fresh water tank, remove cap from the fill. Insert a hose into the 1-1/4 inch flex tube 4 to 6 inches. Open the water supply faucet. DO NOT overfill the tank as it will break. It is not designed to hold pressure.
2. During the tank filling process, check the Tank Monitor Panel for fullness (if applicable).
3. On gravity water fill, you will find a small screen at the 10:00 o'clock position, which is the over flow line from tank. When water squirts of this screen stop filling the tank immediately.

Figure 2



S=Siphon hose used to;

(A) Winterize water system.

(B) Sanitize water line system only.

P=Pump-12 volt DC. To supply coach with water when city water is not available.

F=Filter—Cap to be removed for clean out or replacement.

G=Gravity water fill —to fill tank.

C=City water fill. —to fill lines.

V1= Valve to be open ONLY when using siphon hose as listed.

V2=Valve to be open to draw water from supply tank. Closed when siphon hose is used.

T=Tank to hold water

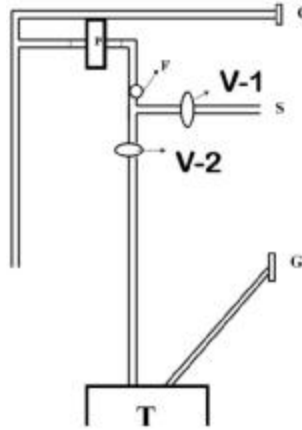

Figure 1

Filling Fresh Water System—#2

1. City Water Fill (figure 1)

Water may be received into the system through a direct hook-up, referred to as a “city water fill.” After attaching a supply hose to hook-up, open the faucet from the supply line. Enter coach and open all faucets to relieve air from the lines. The water heater (if equipped) will fill first. You will experience some air pockets. Allow them to escape before closing all faucets.



On some models, due to floor plan, there is no standard gravity water fill for the storage tank. Inside of coach, close to pump location, on floor in a cabinet you will find 3 valves plus the siphon hose. Valve V-3, needs to be opened to fill supply tank, shown in diagram to the right.

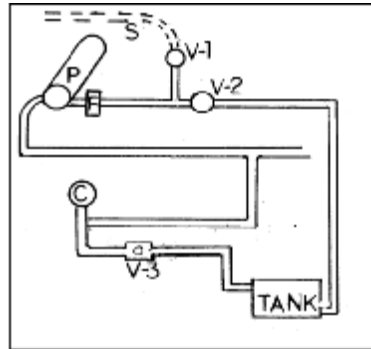

Follow instructions below:

F=Filter.

P=Pump, 12 volt.

C=City water fill.

S=Siphon hose.

V =Valves to operate—open and close/to control water movement in the lines in coach.

V-1=Valve regulates “S” Siphon hose. Must be closed except to draw antifreeze into system or sanitizing solution.

V-2=Valve closes line from tank to pump. Will be open during pump usage.

V-3=valve controls water to storage tank. Valve location is inside of coach normally near water pump, on floor, or under a cabinet.

2. To fill storage tank, attach water hose to "city water fill." Open V-3 valve, then open faucet that hose is attached to. Watch your monitor panel-DO NOT over fill. Close V-3 valve when done.

3. When drawing water from tank, open V-2 valve. All other valves are to be closed.

12-Volt Demand Pump

When water is desired and you are not hooked up to city water, your tank will be your supply. On your monitor panel is a switch to turn on the 12-volt demand pump. Energy for the pump is supplied by the auxiliary battery or converter. The pump will self-prime when started, supply water, and continue to run until approximately 40 pounds of pressure is achieved. When pressure drops to 20 pounds, pump will restart. Some cycling in pump may occur. A check valve is built within the pump to prevent water from flowing into the supply tank.

The pump has a small filter attached on the " in port " side to prevent any foreign matter from entering the pump. You need to annually or even more often, remove the lower screw on cap and clean it out or replace filter.

When pump is not in use, turn 12-volt power off at the switch.

Occasionally your water pump may start/stop quickly (within a second). This is referred to as "cycling". The cause for this annoying noise may be a slightly open faucet, water saver washer in the end of the faucet spout, plus other restrictive issues. If pump cycles every 10 to 15 minutes, there may be a slight water leak somewhere, check valve in city water fill, plumbing fittings, or pressure valve in pump.

Faucets

The basic operation of a faucet is the same as in your home.



Open the knobs or raise the single lever. Close faucets when sufficient water volume is achieved. It is normal to experience occasional air pockets in the system when filling system.

Bath and Shower

Your bathtub and shower are built with ABS, vinyl, or fiberglass material, similar to those in your home. Shower curtains are provided with the coach and must be used to prevent water from spilling onto the floor, possibly causing damage.

The shower head used in the bathroom has a non-positive shutoff valve and will drip slightly in shut-off position. A vacuum breaker is also built into the faucet to permit water in hose to drain out as a code requirement.



Before beginning your shower be sure the water heater is lit. Adjust the faucet for temperature before entering the tub or shower. When shower is completed be sure to turn water off at the faucet.

Used water will drain through the plumbing pipes into the gray water holding tank. Remember capacities of your water heater and gray water holding tank. Long showers in a recreational vehicle are NOT suggested due to the amount of water that is available. To conserve water, wet down, and turn water off while you soap up, then rinse.

Outside Spray Port or Outside Shower

A convenient Hot & Cold faucet, with a 15' coil hose, and spray nozzle is located on the exterior of the unit. This faucet, hose, and nozzle can be used for exterior washing, and rinsing of hands, utensils or other needs.



This faucet contains mandated backflow prevention. Faucet must be drained for storage or if freezing weather is expected.

To Operate Outside Spray Port

1. Open door.
2. Attach coil hose to faucet quick connect.
3. Open faucet valves, and adjust to desired temperature.
4. To end water usage, close faucet valves and disconnect coil hose.

Outside shower has head and hose which is pre-installed, and can be removed as desired.

Fresh Water Line

Two water lines, generally red for hot and blue for cold, transport water through out the coach. Valves to direct water flow are near the city water fill or pump area. Connector elbows and tees are plastic or copper, and are held together with compression rings to prevent leakage.

Low Point Drains

Low point drains are placed on recreational vehicles to drain water lines, tanks, and water heater to prepare coach for winterization and sanitizing systems. Valves may be plastic or brass.

Fresh water supply tanks will have their own separate drains under the floor and/or frame, with a valve to be opened to drain, over flow drain line may be close by.

Plumbing lines also have Low Point drains located in various areas. You may find them (2) for hot and cold coming out of storage areas, outer metal skirt, through underbelly covers, control centers, etc. Water should always drain out to the ground, not into underbelly cover.

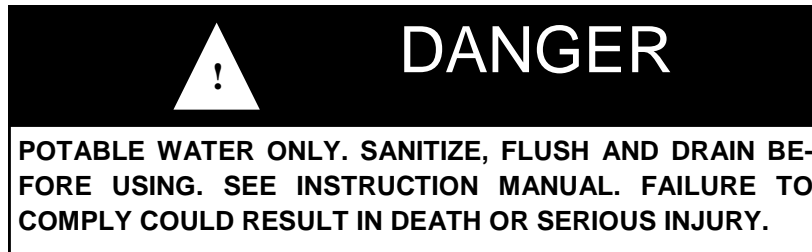

Sanitizing and Filling the Potable Water System

For your safety, you should sanitize your potable water system when your recreational vehicle is new or when it has been sitting unused for a period of time and it may have become contaminated.

Prepare a chlorine solution using 1/4 cup of bleach (5% sodium hypochlorite solution) to one gallon of water. Prepare one gallon of this solution for each 15 gallon capacity of the tank. As designed and constructed, this method will sanitize the plumbing system.

On slide outs containing kitchens they will have flexible hoses installed on both fresh water lines and drain lines. Make sure there are no obstructions to prevent free flow of draining contents.

For Gravity Fill Storage Tanks

1. Close all the drains, low-point drains, and have by-pass closed to water heater.
2. Open lid to gravity fill and pour solution content into tank. A funnel may assist your efforts or be required.
3. You may wish to add extra water for circulation.
4. Open all faucets to allow air to escape. Close V-1 and open V-2 valve.
5. Turn on water pump to supply sanitation solution through out water lines in coach.
6. Close faucets when air ceases to bubble out.
7. Allow solution to remain in tank and system for 3 hours.
8. Drain solution and flush with fresh water.

For Direct Fill-City Water in Storage Tank

1. Close all drains: tanks, low-point, and have by-pass closed to the water heater.
2. With water system completely drained, open V-1 valve and insert siphon hose into container with sanitation solution. Be sure V-2 and V-3 valves are closed. Leave faucets open for air to escape. Close when liquid flows freely. Pump will stop when full pressure is achieved.
3. Should you also desire to sanitize tank, open V-3 allowing water to flow into tank. Pump will start again and run until solution is all gone.
4. Now close V-1 and V-2 with V-3 open, add additional water to tank through the city water fill, 15 to 25 gallons. Faucets may be opened.
5. Allow this solution to remain in system for three hours.
6. Drain this water solution and flush with fresh water.
7. To remove any excess chlorine taste, prepare a solution of 1 quart of vinegar to 5 gallons of water and allow this solution to agitate in tank for several days by vehicle motion.
8. Drain tank again and flush with fresh water.
9. Your demand water system is now ready for use.
10. Turn off pump when not being used.

Drainage (Fresh Water)

All permanent fresh water tanks can be drained. The type of drain used is a turn valve with open/close position. This valve is located under the floor underbelly.

To drain the supply lines and the entire system, you need to follow the steps listed below. Locate the valve placed at the floor level or close to the floor, found under the dinette, storage cabinet, and sofa. These valves will be at the "lowest" point of the water lines.

To drain system:

1. Open all faucets including optional exterior spray port.
2. Open the fresh water tank drain.
3. Open the water heater drain.
4. Open all (two to four) low-point drains.
5. Open the toilet valve, hold or block if need be.
6. To empty the pump, start and allow to run up to 20 seconds.

Sanitation System

Toilets

The toilet used on these models is the Aqua Magic V, hand flush model or foot flush. See operation "how to use".

Prior to using your toilet, be sure to add a proper amount of deodorant chemical into the toilet with water. Flush contents into tank plus two or three gallons of water.

After each flush, about two inches of water will be in bowl, which is fine for travel. During usage, keep 4 to 5 inches of water in bowl to assist with flushing solids..

OPERATION: Note the following photo for hand lever operation. To flush, press lever all the way forward as shown. To add water press lever half way forward. Should your camper have foot flush, hold pedal down half way for water only and all the way for full flush.



Unlike the toilet in your house which uses four to seven gallons of water per flush, a recreational vehicle uses two to three quarts to save water and space. When insufficient water is used during flushing, waste materials may not evacuate properly from drain lines to tank, causing "clogging" in pipe.

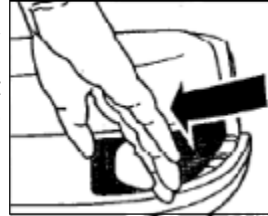

When hooked up to a sewer drain at a camp ground, ALWAYS keep the termination valve CLOSED until the tank is at least 3/4 full. This will provide sufficient water to assist in complete draining of tank.

Manufacturer of toilet, Thetford Corp., offers a complete line of deodorants, chemicals, and other convenience products for your use. Your dealer can assist you with these needs and may already have them in stock.

Using Toilet and Tank System

The toilet system performs better when you run water 10 to 20 seconds after flushing to ensure wastes will proceed to the bottom of the tank.

	CAUTION
It is important to use adequate water to flush and have several gallons of water with chemicals in the tank. This helps the flow of wastes and reduces solid waste build-up.	

	CAUTION
NEVER leave the gate valve of your coach's sewage tank open when hooked up to a park's sewer system. Open only when you wish to drain system.	

Vents

A very important part of your sanitation system is the vent system in your coach. These vents release air from holding tanks allowing water to enter. Vent pipes are attached to the holding tank, go through the walls, cabinets, the roof and vent outside. On some

models a portion of vent pipe may be part of the drainage system referred to as a "wet vent". As air flows upward, water will be draining downward.

Holding Tanks

The final parts of your sanitation system are the holding tanks for waste materials and water. These are located below the floor of your coach.

Gray Tank. Waste water from the bath tub, shower and sinks will drain into this container. No special preparation is required, however, you may wish to add baking soda or a Thetford chemical to reduce odors from food particles in the system.

Waste Tank. The toilet drains into the waste or "black" holding tank. For correct preparation follow the listed steps:

1. Release two quarts of water into the toilet bowl.
2. Place the recommended quantity of chemicals for waste holding tank as per instructions on the bottle into the toilet bowl.
3. Flush liquids into the tank and allow up to two gallons of water to flow into the tank.

Each time you drain the tank, you should follow the proceeding above instructions before using.

All drain pipes will have a "P-trap" installed into each line. Water in these traps prevent odors from escaping into the coach. During travel, water from the P-traps may spill and permit odors into the coach. These odors come from fats and food particles decomposing in the tank. By adding water and using a RV approved deodorizing agent, contents will dissolve faster, keeping the drain lines and tanks clean and free flowing. These chemicals are available at a RV supply store.

Draining the Tanks

A final part of your sanitation system is the drainage of holding tanks. Realizing dump stations will vary, place the coach as level as possible to make drainage easier. Some tanks drain from the center requiring level or slightly up in front. Others will drain from end permitting a slight tilting to the side which drains are on.

Remove the cap and attach the adapter onto the valve housing. Turn the adapter 10° to lock onto the pegs. Attach a flexible sewer

hose to the adapter and secure with a clamp. Place the other end into the approved sewer system.

You may now open the 3 inch drain valve to drain the sewage tank first. Open the valve on the gray water tank last to utilize water to wash and rinse the hose and drain lines.

Most states and parks have strict laws and regulations to prohibit dumping of wastes of any kind into anything other than proper disposal facilities or sewer systems. Almost all privately owned parks have either a central dump facility or offer a campsite hookup for sewage. You can find lists of many dump facilities throughout the United States in *Woodall's, Rand McNally Camp Guide, Good Sam Camp Guide, KOA Campgrounds Camp Guide*, or various other publications. Some fuel stations also have dump stations.

Flush System (OPTIONAL)

The flush system is designed and built to rinse the waste holding tank, after waste tank has been drained completely of water and solids.

1. Attach a fresh water source to the connection marked "Sewer tank Flusher". Be sure termination valves are open on tanks.
2. Open valve to release water into tank for rinsing and cleaning of your waste water holding tank.
3. Rinse for several minutes to remove any foreign matter from tank and probes.

Remember the moisture content may give you a false reading on your monitor panel indicating it is full. Allow time to dry out tank or recharge for next usage.

CAUTION

DO NOT use the tank flush valve unless the termination valve is in open position.

Can result in unsanitary condition leading to illness or injury.

Maintenance for Holding Tanks

The following maintenance is recommended by our holding tank suppliers to keep your tanks clean and keep the probes free of debris and build-up.

Gray (Waste-Water) Tank. Fill tank with 8-10 gallons of warm water.

Add a degreaser such as a citrus cleaner or Dawn dish soap. Leave solution in tank while you are traveling. Rinse and drain tank.

Black (Sewer) Tank. Fill tank with 8-10 gallons of water. Add one bottle of drain cleaner, such as Drano or Liquid Plumber. Leave the solution in tank while traveling. Rinse and drain tank.

Heated Holding Tanks. Method used to distribute heat is by placing holes from tank compartment into heat duct built into floor, allowing warm airflow throughout tank area. Tanks are insulated.

	DANGER
DO NOT use Ethylene Glycol (automotive antifreeze) or Methanol (windshield washer antifreeze) in your fresh water system because they are harmful and may be fatal if swallowed!	

Winterizing Your Recreational Vehicle

Preparing your trailer for cold weather is very important for most states and Canada. Failure to prepare your coach for cold weather will cause the water systems to freeze resulting in breakage. Damages related to freezing are not covered under the terms of your limited warranty.

Two methods of winterizing your coach after draining and flushing your drainage system are as follows.

Method 1:

1. Open all faucets, low point drains and toilet valve to drain all water. Leave these open during this procedure.
2. Start pump and operate until all water has been removed, takes about 10 to 15 seconds.
3. After water has been drained, use an air hose from compressor and an adapter attached to city water fill. In about 3 to 5 minutes all water will be blown out of system.
4. Pour one (1) pint (16 oz) of non-toxic RV anti-freeze into each P-Trap. Each sink has a P-Trap as does the bathtub.

Method 2:

The water heater bypass kit is designed and built to avoid having antifreeze in the water heater.

1. Turn off the pump.

2. Drain the water heater and the entire water system.
3. Close the valve on the bottom and top of the by pass kit to prevent liquid from entering the water heater.
4. Place siphon hose into container with anti-freeze.
5. Valve,V-1 must be open and V-2 must be closed.
6. Open all faucets for air to escape.
7. Turn water pump on to supply lines with antifreeze. It will take. 2 gallons or more, depending on length of lines.
8. You may wish to place a quart container under faucet to catch extra antifreeze.
9. Closest faucet to pump will fill first .
10. Turn pump off when all faucets emit antifreeze.
11. Take contents in container and pour 1 pint in each drain to protect each P-trap.
12. Any left over antifreeze in container can be retained for future use.

BY PASS KIT

Valves — Handles in horizontal position allows water to flow into and through water heater and from water heater upon demand. Valve on bottom and top portion of by-pass, are choice directional flow valves, not shutoff valves.

When bottom valve is in vertical position it will prevent water from flowing into water heater. Valve on top of by pass kit, when in vertical position, will not allow back flow into water heater. Now you can send anti-freeze liquid through coach plumbing system without filling water heater.

Several reasons for not placing antifreeze into water heater:

1. Costly— Would take an extra 6 to10 gallons of antifreeze.
2. Anti freeze can be very corrosive to the anode rod causing premature failure.
3. Leaves sediment in the tank.

Using the Water System During Freezing Weather

Your towable RV was not intended to be used during freezing weather unless special precautions are taken. Water freezes at 32 degree Fahrenheit in camp grounds or home.

There is no product that can be added to the water to ensure freeze protection when system is in use, other than RV antifreeze. DO NOT drink water which contains any type of antifreeze or use to shower.

PROPANE FUEL SYSTEM

The fuel system in your recreational vehicle has numerous components such as, piping, copper tubing, brass connectors, hoses, regulators and appliances. Each of these components will be explained in its appropriate area.

Propane is the only fuel permitted to be used in a recreational vehicle and its appliances. This product is refined from crude oil through natural gasses. An agent has been added for detection should a leak occur or a valve accidentally be left open. It is important for a recreational vehicle owner to recognize and identify the smell of propane vapor for his or her safety.

Other fuels are available but cannot be used in a RV because:

1. No orifices are available for appliances for either butane or natural gas fuels.
2. Butane CANNOT be used below freezing temperature because boiling point is 30 degrees Fahrenheit.

Propane fuel is stored in liquid form under high pressure in special containers. Boiling point is (minus) — 44°F, the temperature when vapor ceases to flow. Fuel will change to vapor when released from the container. Appliances are not designed to operate with liquid. Liquid will damage o-rings in valves and also leave sticky, oily residue causing poor or no operation in the regulator.

For every 10 degree increase in temperature, the pressure of propane in container rises 1.5%. Example—fill at 0 degrees in north, go south to 80 degrees, you now have container filled at 92%, a potential problem with 10% valve spewing out propane vapor.

Propane Container

The propane cylinder is a D.O.T. approved container to hold liquid under high pressure, normally a 20 or 30 pound capacity.

The open/closing valve, referred to as an OPD cylinder valve, is to be closed at all times unless hooked up to a propane system or when filling the container.

Valve assembly actually has 3 valves in one body.

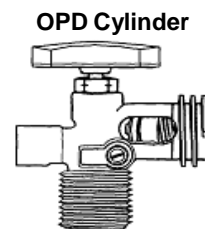

1. Main pass thru portion to fill container and draw propane out is controlled by upper 3 sided knob on top.
2. A small screw on the side of main body referred to as 10 % valve which allows air to be released and indicates when container is filled to 80 % capacity.
3. Incoming positive seal valve MUST be pushed inward with fill nozzle or by POL fitting to draw vapor out for appliance use.

On the bottom/inside is the float which closes when 80% of capacity has been reached. This permits expansion space in tank when temperature rises. See section on main hoses.

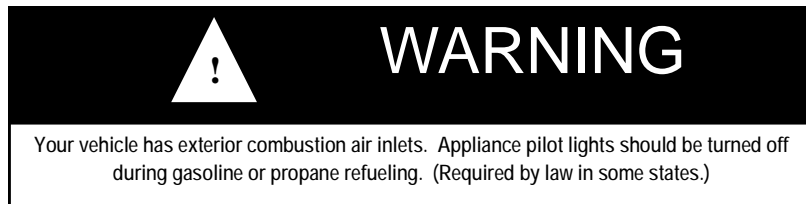

At any point a container is disconnected, BE SURE to install the “dust cap” over valve entry (if so equipped). Whenever the container is detached from the propane system, DO NOT allow the cylinder to move or roll around while transporting to and from the propane supplier.

Servicing and Filling Propane Containers

Filling a propane container must be done carefully and correctly. Only a qualified person, properly trained on inspection, filling and safety procedures, should fill containers.



A new container MUST be “purged” before placing into service and MUST NEVER BE OVERFILLED. Purging is an operation performed by your dealer or propane agency to remove any atmospheric air. As an owner you need not be concerned regarding this procedure unless you permit the top valve to be in OPEN position when empty and unhooked to container.

Two overfill devices are built into the valve to prevent overfilling of the container. First, is the small brass “knob” or “screw” inside of the valve. This “10% valve” must be open when filling, allowing air to escape. When the container reaches 80% of the correct capacity, liquid appears.

Secondly, containers with OPD valves have a float on the inside that automatically shuts off liquid flow when the 80% capacity has been reached.

When refilling propane containers, they are generally removed from propane compartment or tie downs. **BE SURE** to reinstall correctly, as shown in installation instructions, and test for leaks.

When propane containers are filled to 80% level there is available space for safe expansion of the vaporized liquid.

	WARNING
<p>A warning label has been located near the propane container. This label reads as follows:</p> <p style="text-align: center;">DO NOT FILL CONTAINER(S) TO MORE THAN 80 PERCENT OF CAPACITY.</p> <ol style="list-style-type: none">1. Overfilling the propane container can result in uncontrolled gas flow, which can cause fire or explosion.2. A properly filled container will contain approximately 80 percent of its volume as propane.	
	CAUTION
<p>DO NOT use tools to open or close the tank valve. HAND TIGHTEN ONLY to avoid damage to the valve or handle.</p>	

Should your container become over filled, such as on older coaches, it could cause the overflow valve to “blow-off” and emit a small quantity of propane vapor. This can be detected by a strong odor around tanks. Keep open flames away from this area.

It is best to remove the container, take to a safe area, and burn off the excess pressure for several minutes with a torch.

When disconnecting propane containers, you must turn the ACME fitting in a clockwise direction because left-hand threads are utilized. When reconnecting, turn connections counterclockwise. Connections must be tight, however **DO NOT** over-tighten.



INSTALLING PROPANE CONTAINERS

KZ recreational vehicles are equipped with 20 and 30 pound propane containers, depending on floor plan models and size of coach.

Mounting and attaching instructions are listed below.

1. Thread the long rod into the base plate.
2. Set both bottles into place as shown on page 65.
3. Drop the double hook bracket over the rod and hook onto the bottle.
4. Attach the wing nut to hold the bracket and tighten to hold the bottle to the plate.
5. Attach the regulator with the vent down to the bracket.
6. Attach the main hose from the regulator to the manifold fitting in the frame.
7. Attach two short pigtail hoses to the regulator and bottles at the ACME fitting.
8. Test all propane connections for leakage.

A warning label has been located near the propane container. This label reads as follows.

	DANGER
Propane cylinders shall not be placed or stored inside the vehicle. Propane cylinders are equipped with safety devices that relieve excessive pressure by discharging gas to the atmosphere. FAILURE TO COMPLY COULD RESULT IN DEATH OR SERIOUS INJURY.	
	WARNING
Never smoke during the filling of propane tanks. Keep the recreational vehicle away from immediate filling area when possible or extinguish all propane appliances.	

1. Knob to open and close main valve.
2. Complete valve assembly.
3. "10% valve", (small brass knob or slot screw).
4. Container mounting stand.

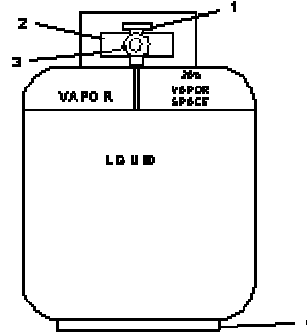

CAUTION

THIS GAS PIPING SYSTEM IS DESIGNED FOR USE WITH PROPANE ONLY. DO NOT CONNECT NATURAL GAS TO THIS SYSTEM.

Securely cap inlet when not connected for use. After turning on gas, except after normal cylinder replacement, test gas piping and connections to appliances for leakage with soapy water or bubble solution. Do not use products that contain ammonia or chlorine.

ALL PROPANE LINES HAVE BEEN CHECKED WITH AIR PRESSURE. DEALERS ARE REQUIRED TO RECHECK WITH PROPANE IN TANK BEFORE DELIVERY TO RETAIL CUSTOMER.

Regulator

Propane regulators must always be installed with the vent facing downward. Regulators that are not in compartments have been equipped with a protective cover. Should vent be covered, the regulator cannot operate.

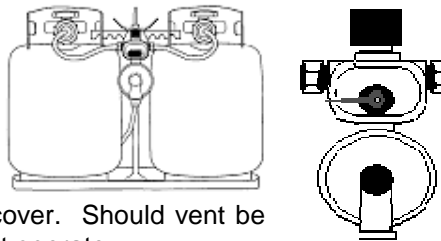

The regulator has the only moving components in the propane system. It's sole function is to reduce the high and varied pressure from the propane containers to safe and consistent low operating pressure. The small inlet is the first stage, which reduces the container pressure to 10-13 pounds.

The second stage then reduces the 10-13 pound pressure to an operating pressure of 11 inches WC (water column) or 6.35 ounces of outlet pressure to your appliances. The second stage is adjustable and may need to be adjusted for precise operation. It is suggested this to be normal maintenance and performed once per year. Do not make this adjustment without a manometer or U-tube. This instrument is required to read actual pressure.

If pressure is too high, it affects performance and safety. Should pressure be too low, appliances will not operate correctly. An authorized technician with proper equipment should perform such tests and adjustments, as may be required.

The standard type is the "automatic" two stage regulator used on larger coaches. With both cylinders full of propane, turn the lever on the regulator towards the cylinder you wish to use first. This will now be the "supply" cylinder and the other "reserve". Slowly open both cylinder valves.

The indicator on top of the regulator will turn bright green. When the cylinder becomes empty the indicator will change to bright orange or red. Now turn the lever to the side of the full bottle and the green signal will return. You may now remove the empty bottle to have it refilled without interrupting the flow from the full bottle. After filling the cylinder, connect the pigtail hose and slowly open the bottle valve. Do not forget to check for leakage each time you refill cylinder or disconnect any part on the propane system.

High Pressure Hoses with Acme Connectors

Propane leaves the container through a hose with an ACME connector attached to the bottle, also having a "flow-limiting device".

1. Should the container valve be opened too quickly, this device may close, stopping the flow of propane. 2. Should there be rupture in propane line, it will reduce the flow to a maximum of 10 (SCFH) Standard Cubic Feet per Hour. This valve will equalize normal flow in about 5 seconds, generally not noticeable.

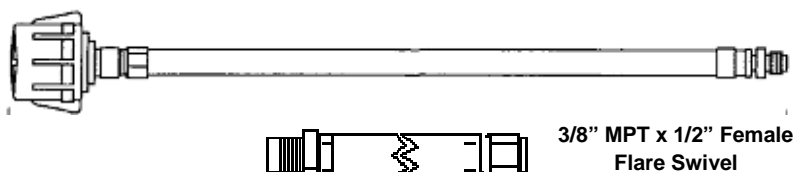

Main Supply Hose – Low Pressure

The main supply hose will be attached from the regulator to the brass manifold fitting in the frame of the coach. The swivel brass nut on the main hose will be your final attachment.

There are several things to remember each time the container is removed

1. Be sure ALL fittings are tight. Always use two open end wrenches for brass connections.
2. Be sure ALL connections are tested for leakage.
3. Open the main valve slowly to avoid a fast rush of gas to flow-limiting device causing gas “freeze”.
4. Listen carefully – a “hissing” sound longer than one second may indicate a gas leak. Close valve and search for leak.

Should you experience a gas “freeze-up”, close the main valve and wait 15 minutes before trying again. Keep the container valve (s) closed when traveling. Some states prohibit traveling with the propane container valves open, especially in underground tunnels on expressways.

Operation

After the camper is completely set up and you are prepared for camping enjoyment, follow these steps for propane operation.

1. Be sure ALL burner valves, controls, and pilot light valves are closed.
2. Open main valve on propane container slowly to avoid a fast rush through excess flow valve causing “propane freeze”.
3. Listen carefully as propane begins to flow. If a “hissing” sound is heard for more than one or two seconds, close valve and search for a potential leak. Solve leak before proceeding.
4. Light appliances as needed and directed in Chapter Five - Appliances

Checking for Leaks

The entire propane distribution system and appliances have gone through complete factory and dealer tests for any leakage. When traveling with your RV normal vibrations and road movement may cause connections to loosen and develop leaks.

For normal maintenance we advise all owners to test for leakage at least once per year or more often. You may request your dealer to perform a maintenance check each spring.



DANGER

If You Smell Propane:

1. Extinguish any open flames, pilot lights, and all smoking materials.
2. Do not touch electrical switches.
3. Shut off the propane supply at the tank valve(s) propane supply connection.
4. Open doors and other ventilating openings.
5. Leave area until the odor clears.
6. Have the propane system checked and leakage source corrected before using again.

FAILURE TO COMPLY COULD RESULT IN EXPLOSION RESULTING IN DEATH OR SERIOUS INJURY.

Should you encounter an odor, possibly propane, turn off any and all open flames and begin a systematic search for leaks on the complete propane system. **NEVER USE A MATCH.** Use a soapy water solution which contains **NO AMMONIA** or **CHLORINE** content to search for leaks. If a leak is identified, bubbles will appear. **ALWAYS** use 2 open end wrenches, preferable 6 point when tightening brass connections to prevent twisting of copper tube.

For your own protection, the preceding warning labels has been placed near the cooking area to remind you of the need of oxygen for combustion and breathing. Due to smaller area in your recreational vehicle, there is less oxygen than in your home. Proper ventilation is required when cooking.



DANGER

IT IS NOT SAFE TO USE COOKING APPLIANCES FOR COMFORT HEATING.
Cooking appliances need fresh air for safe operation.

Before operation:

1. Open overhead vent or turn on exhaust fan.
2. Open window (s).

FAILURE TO COMPLY COULD RESULT IN DEATH OR SERIOUS INJURY.

BESURE you as the owner knows and understands what the odor of propane is.

It is especially important that cooking appliances **not be used for comfort heating**, as the danger of asphyxiation and unsafe levels of carbon monoxide are greater when the appliance is used for long periods of time.



DANGER

Portable fuel-burning equipment, including wood and charcoal grills and stoves, shall not be used inside the recreational vehicle. The use of this equipment inside the recreational vehicle may cause fire or asphyxiation.

! DANGER

ALL PILOT LIGHTS, APPLIANCES AND THEIR IGNITORS (SEE OPERATING INSTRUCTIONS) SHALL BE TURNED OFF BEFORE REFUELING OF FUEL TANKS AND/OR PROPANE CONTAINERS. FAILURE TO COMPLY COULD RESULT IN DEATH OR SERIOUS INJURY.

Propane Consumption

All your propane appliances are operated intermittently. Your furnace is naturally the appliance using the most fuel, especially if freezing conditions are present outside. On a very cold and windy day it is conceivable that your coach could consume most of a 30 pound propane bottle.

Propane consumption depends mostly upon individual use of appliances and the length of time operated. Each gallon of propane produces about 91,500 BTUs of heat energy. Following is a list of typical appliance consumption when turned on fully for one hour of operation.

APPLIANCE	LP GAS CONSUMPTION
Water Heater	12,000 BTU
Furnace	20,000-35,000 BTU
Stove/Oven	6,500-9,100 BTU
Refer	1,200-2,200 BTU
Note: The above chart represents many different models.	



CAUTION

If you have double bottles and a standard regulator on your RV, use only one bottle at a time. Otherwise the propane supply will be drawn equally from both bottles until supply has been totally exhausted. Using one bottle until it is empty, then using the second bottle will allow you to fill the empty bottle at your convenience without being totally out of propane.

ELECTRICAL SYSTEM

General Information

The electrical system in your recreational vehicle is designed for using both 120 volt AC (alternating current) and 12 volt DC (direct current) capabilities. All installations and designs are built to comply with safety requirements of ANSI standard A119.2, National Electric Code and Canadian Standards Association.



30-A, 125-V, 2-pole, 3-wire,
grounding type



50-A, 125/250-V, 3-pole, 4-wire,
grounding type

All coaches manufactured by KZRV have 30 amp service, and some units have optional 50 amp service available.

Highly recommend that your RV electrical connection, is not plugged into a household outlet.



CAUTION

A 50 amp service is a 240-volt hook-up. There is no appliance or other component requiring 240 volts in this coach. For more information, see the section later in this chapter, 50 Amp (Optional).

Changes and Modifications

Any changes, alternations, additions, and/or modifications need to be performed by qualified electrical technicians, using only approved components which meet safety and code requirements. This includes owners, dealers, etc. who desire to make changes. The manufacturer is not responsible for any changes, or alterations, made to the 120 AC system of the coach.

120-Volt A/C System

Power Cord 30 AMP or 50 AMP

All units have 30 Amp or 50 Amp power cords that are detachable from the inlet connection as shown, (following page) the cords are to be stored inside of the unit when not in use. This cord places 120 AC volt power into your main breaker distribution center, as built into your coach.

Energy will enter through the main breaker and is distributed through circuit breakers to the wall receptacles and appliances. This power cord will be approximately 26 to 28 feet in length. Each cord has the correct gage of wire to carry the correct voltage to the coach.



In some hookups the power cord may not be long enough and extension cords are required. Always use a cord with the gauge of wire equal to or greater than the power cord. Should you use a cord with a smaller wire gauge, overheating, loss of amperage, and possible melting could occur.

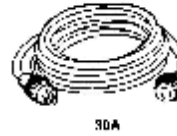

DO NOT leave any unused portion of an extension cord in a "coil" as it may overheat, short-circuit wires and potentially destroy your extension cord.

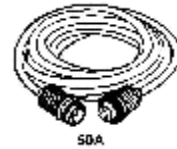

! WARNING

Never use a "cheater" plug or extension cord which breaks the continuity of the ground circuit to the grounding pin.

Circuit Breakers and Box

On a 30 amp system, a maximum of six distribution circuits are permitted. All breakers are sized according to power needs on each line.

The following generic drawing (following page) shows the circuit breaker alignment with number one being the main breaker on all floor plans.

An owner must realize and understand that a coach has a total of 30 amp service available to be used. Conserving and choosing which appliance has priority in consumption needs to be part of the planning.

! WARNING

Do not replace breakers or fuses with any that are rated at a higher amperage. Over fusing may cause a fire by overheating the wire.

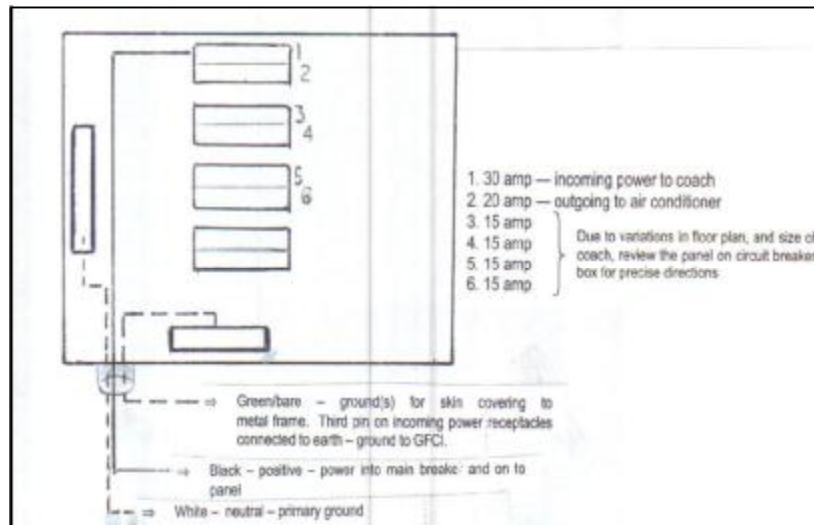

Don't forget loose items such as toasters, coffee pots, etc., also consume power. Include these in your planning.

Distribution of 120 volt A.C. power is accomplished in this manner. No 1 breaker is 30 amps incoming main breaker to supply the coach. Normally the second breaker, 20 amps to feed air conditioner. Breakers 3 thru 6 will supply the rest of 120 volt needs.

Your 30 amp plug appears like a 240 volt plug residential connection on appliances, it is NOT. Should you attach your R.V. into 240 volt A.C. you will send 120 volt A.C. power thru white wire and fry appliances, which is not covered by KZ RV warranty.

DANGER

NEVER, under any circumstances, remove a grounding pin in any cord or plug. It may mean the difference between LIFE OR DEATH.

50 Amp (Optional on larger coaches)

On some larger coaches with more appliances that require more 120-volt AC power are desired by owners. Availability of 50 amp service is the best and only method, providing you have 50 amps of incoming power, if this option is available on your unit.

For this application a larger circuit breaker box is required as there are two separate banks of 120-volt AC power on the positive position. Each positive bank receives a 120 volt wire marked "X" or "Y" plus a white neutral wire and green/bare ground to complete circuitry.

Actually these two positive wires added together are 240-volt AC service yet serve two separate banks as the external sticker indicates. A 50 amp main breaker will distribute current to separate banks, verifying 240 volts are present. There are no 240 volt appliances in this coach.

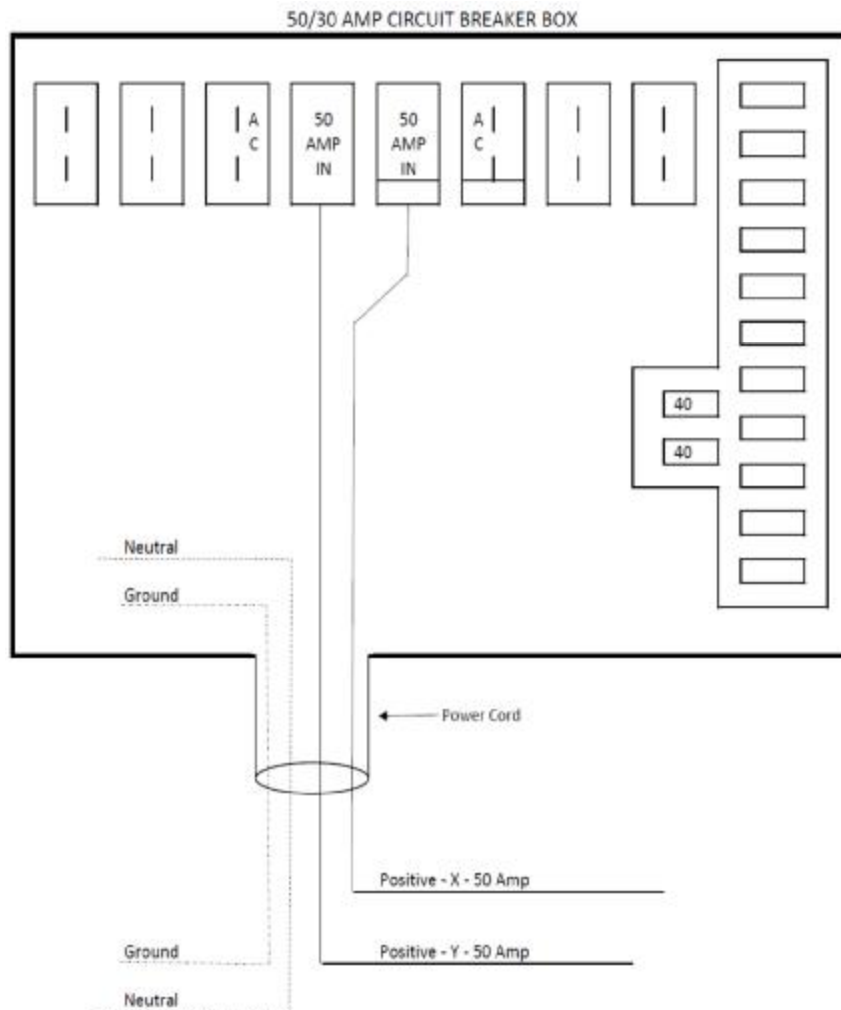

If use of a “reducing” adapter or pigtail is needed because 50 amp four prong service is not available, several things must be remembered.

1. A “reducing” adapter prevents you from using 50 amp service as designed, permitting only 30 amps or less to enter your coach.
2. Should you choose to plug your camper power cord into a building receptacle, BE SURE it does NOT have (2) two positive wires which will be 240 volt AC Power.

GFCI Protection

Each coach has a GFCI, Ground Fault Circuit Interrupter, protection receptacle installed into the circuitry. In the event of a ground fault, a GFCI will trip and quickly stop the flow of electricity to prevent serious injury. Ground fault causes are from reverse polarity, faulty insulation, using a 2-wire extension cord, moisture and earth ground. Instead of following it's normal safe path, electricity passes through a person's body to reach the ground. For example, a defective appliance can cause a ground fault.

Sometimes you may find this GFCI is in the circuit breaker in the distribution box.

The third “round” pin on the receptacle is very important for this safety device to function correctly. NEVER cut off this pin. When using an appliance in the receptacle without this provision, use an adapter with a pigtail to be attached to the receptacle box to complete the circuit.

This GFCI receptacle will not protect against short-circuits or overloads. The circuit breaker or fuse in the electrical panel which supplies power to the circuit provides this protection.

Polarity is extremely important. You should be certain that the polarity of the external power is not reversed, in order to avoid harm to appliances and personal electrical shock. Polarity testers may be purchased in most electrical and hardware stores with the GFCI tester built in.

During use of the recreational vehicle it is suggested to test this receptacle once per month. To test, press the “TEST” button in. The “RESET” button should pop out. Power should now be turned off at this receptacle and any receptacles down line. To restore power, push, then release the “RESET” button.

12-Volt DC System

Most interior lights and appliances receive 12-volt DC power through converter output and/or the auxiliary battery. Exterior lights and brakes also use 12-volt DC power from the tow vehicle battery and/or auxiliary battery through the seven way connector and wire attached to the tow vehicle. Following are explanations of various items.

Converter

The heart of your 12 volt DC system is enclosed inside of the load center, including 12V fuse panel, 120V breaker panel and converter unless you have 50 amp service, and a free standing converter.

Fuse panel will have numerous fuse positions, depending on output size of converter and requirement of your coach.

All converters have solid state electronic components internally to produce "clean" 12V DC power.

This load center will have a brown plastic front panel with a small door to access fuses and breakers.

Some models with 50 amp service have fuses and breakers in separate distribution box, with converter installed in a different location (not mounted into distribution box).

The function of a converter takes 120-volt AC power and transforms this energy into 12-volt DC power as used in your coach. 12-volt DC supplies power for some appliances and most interior lights. The floor plan and size of coach indicate the output size.

When the converter receives 120 AC power, it transfers power into 12-volt DC without any manual switches. The converter also charges the auxiliary battery (s) when installed on the coach and is attached to 120-volt AC power. The third function of a converter is to send 12-volt power to the fuse panel and throughout the coach.

Each converter has a "built-in" fan which operates through a load sensor control or temperature sensor. As more current is drawn, fan will speed up, run faster, or slow down, based on amp draw and/or temperature. Should the fan not run at all, the converter may overheat and will cut-out and/or stop.

Auxiliary Battery (NOT SUPPLIED) 12 volt DC.

All travel trailers and fifth wheels are pre-built to accept a battery. Batteries are not standard equipment, nor are they an option. To purchase battery, contact your dealer, or battery center.

Recommended batteries are of deep-cycle type as you need longer, slow consuming power rather than cold-cranking power. A battery of some type is always required for a break-away switch to function.

A battery requires routine maintenance for long life. First, terminals need to be kept clean to avoid corrosion. Second, a battery used daily will consume water as long as the converter is in operation, unless it's a "sealed battery". Be sure to check the battery no less than every 30 days and keep the battery filled with distilled (rain) water. Most good deep cycle batteries are NOT maintenance free.

A converter will not overcharge a battery unless a battery has a dead cell, or the converter has a malfunction. Some type of converters have full battery charge shut-off. Other types reduce the rate of charge as battery conditions reach 12.7 volts DC or 1.265 specific gravity at 80°F. By electronic standards, a battery is discharged at 10.5 volts. Dropping voltage lower than 10.5 volts will begin damaging plates in the battery.

The interior lights will operate from the converter and/or auxiliary battery. Some lights will have wall switches and other lights have switches in the lights themselves.

Circuit Breakers and Fuses—12 Volt DC

These two items have been installed in your coach to protect circuitry and components.

Fuses are placed into the fuse panel with the converter or into a separate panel near the converter with access inside of coach. Fuses are placed in your electrical system to protect wiring and components when overloads appear or short circuits occur. Radios, stereos and possibly other components may have "in-line" fuses attached to their own wire harness. Two 40 or four 20 amp fuses are in converter, protecting the converter should you connect a battery up backwards. Fuses will blow rather than converter.



WARNING

DO NOT replace circuit breakers or fuses with a higher current rating than those supplied with your coach. Over-fusing can cause a fire hazard by overheating the electrical wiring.

Circuit breakers are placed at several locations. An automatic reset breaker is placed within 18 inches of the auxiliary battery. This breaker will automatically reset upon “cool down”, normally within 60 seconds.



A 30 and 20 amp breaker is used for the automatic reset breaker which is installed in the load center to operate your slide-out (s). All wiring used in your coach meets correct amp rating correlated with fuses and breakers in respective panels as required by code.

The RV battery is placed in parallel circuitry with the battery on your tow vehicle. Care needs to be exercised not to drain both batteries together. There are two methods of avoiding this condition.

First, disconnect the tow vehicle when parked and/or using your coach.

Second, a battery isolator may be installed in your tow vehicle to prevent power drain from batteries in both vehicles. This device “isolator” has two useful purposes. First, it sends current from the alternator to both batteries simultaneously. Secondly, the isolator prevents draw from the tow vehicle battery preserving power to start the engine.

Contact your dealer should you desire an isolator for your protection. Two types are available, mechanical type, or solid state which is the best and most expensive.

POWER CUT-OFF SWITCH FOR BATTERY

This switch is normally located inside of front baggage area with a red knob. In vertical position is OFF. Turning knob 90 degrees to right will be in the ON position. Remember, if switch is turned off, battery can not be charged. Along with the switch, there are 2 or 3 12 volt breakers under the black cover beside the cut-off switch. Size of these breakers are 6, 10, 20, 30, and 50 amp energizing various items in coaches.

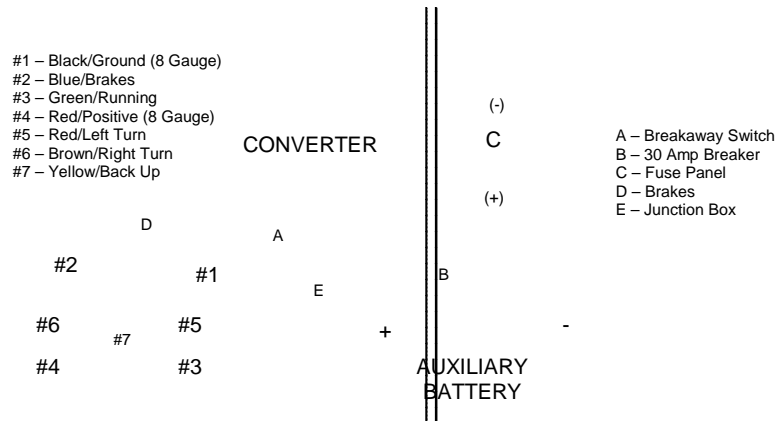

Exterior Lights and Connector, 12 Volt

Power for exterior lights, such as tail lights, turn, clearance and brake lights, is supplied by the tow vehicle.

Note the diagram (above) showing the color code and numbers from the seven way connector and how power is fed to the exterior lights. The positive red wire is attached to the battery to transfer power to the coach.

The connector between the recreational vehicle and the tow vehicle may build up corrosion due to moisture. You may need to clean these terminals occasionally to insure good electrical contact.

Porch Lights

Porch lights are placed on sidewalls, left and right side. Switches for these lights, depending on models, will be in the interior, right and possibly left sidewall. Occasionally, the switch will be on the light itself.

Brake Wiring

Both 10 and 12 inch electric brakes operate on 12-volt power supplied from the tow vehicle, transferred through the blue-positive and white-negative in the seven way harness. There are no fuses or breakers installed in this brake wiring. More information on the brake system is found in Chapter Three - Using Your RV.

If experiencing any electrical problems, check the following items, fuses, breakers, and connections. If none of these resolve the problem, contact your dealer for trouble shooting and needed repairs.



CAUTION

Any electrical installation that does not meet the criteria of the manufacturer's specification will VOID THE WARRANTY on the electrical system.

CHAPTER 5 APPLIANCES

KZRV places brand name, quality-built equipment, as guided by current codes and standards, in all recreational vehicles. Some appliances are built and equipped to operate on propane gas ONLY. DO NOT attempt to operate on natural, butane or methane gas.

Each appliance has its own specific manual, written and published by its manufacturer. These manuals supply additional information about the appliances in your recreational vehicle.

The first four appliances in this chapter use propane for their main source of fuel, some use 12 volt DC and 120 volt AC energy also. Chapter 4 has more information on propane and it's use.

IT IS VERY IMPORTANT THAT YOU AS AN OWNER AND OPERATOR ARE FULLY AWARE WHAT THE SMELL OR ODOR OF PROPANE IS FOR YOUR PROTECTION.

The below "**DANGER**" information is placed in the manual and a sticker is located inside of your coach.

	DANGER
IF YOU SMELL PROPANE	
<ol style="list-style-type: none">1. Extinguish any open flames.2. DO NOT touch any electric switches.3. Shut off propane supply at container valve.4. Open doors and windows for ventilation.5. Leave the area until odor clears.6. Evacuate ALL persons from the vehicle.7. Have system repaired before using coach again.	
FAILURE TO COMPLY COULD RESULT IN SERIOUS INJURY, EXPLOSION, OR DEATH.	

FURNACE

The furnace in your recreational vehicle requires 12-volt DC electrical current and propane gas energy for correct operation. The furnace receives 12-volt DC power from a fully charged battery and/or the converter in the coach. This power **MUST** be present before



propane can enter through the control to the burner tube. The combustion chamber is completely sealed to prevent any carbon monoxide from entering into the coach. Oxygen is drawn into the chamber through the upper vent and exhaust fumes are expelled through the lower vent.

Your basic operation is performed through one of two types of thermostats shown.

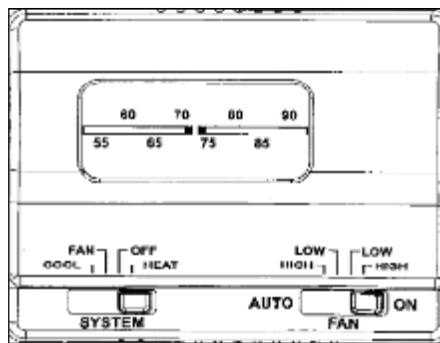
Thermostat (below) on left is for coaches with out central air and on the right side is with central air conditioning,



NOTE: Different model furnaces are used for different unit floor plans. Each model furnace has it's own Users Manual. The following instructions may vary slightly from the instructions in your unit. Therefore it is very important that you refer to the Users Manual provided in your unit from furnace manufacturer.

	DANGER
If you do not follow these instructions exactly, a fire or explosion may result causing property damage, personal injury or loss of life.	
	DANGER
If the user of this appliance fails to maintain it in the condition in which it was shipped from the factory or if the appliance is not used solely for its intended purpose or if appliance is not maintained in accordance with the instructions in this manual, then the risk of a fire and/or the production of carbon monoxide exists which can cause personal injury, property damage or loss of life.	



WARNING

DO NOT operate furnace while vehicle is in motion or being towed.

OPERATING INSTRUCTIONS

Note; During initial firing of this furnace a burn-off of excess paint and oils remaining from manufacturing process may cause “smoking” for 5-10 minutes, which may have been done by your dealer.

FOR YOUR SAFETY — READ BEFORE OPERATING

- A. This FURNACE DOES NOT have a pilot. It is equipped with an ignition device which automatically lights the burner. DO NOT attempt to light the burner by hand, lighter or matches.
- B. Do not use this appliance if any part has been under water. Immediately call a qualified service technician to inspect the appliance and to replace any part of the control system and any gas control which has been under water.

Operating Instructions

1. Before using furnace, it's suggested to open entrance door and windows to air out camper for any unusual odors such as propane.
2. Be sure propane bottle has fuel and valve is open.
3. Release thermostat from “OFF” position and onto “HEAT” position.
4. Set temperature to 5 degrees above room temperature.
5. Blower will start in 0-15 seconds, run for 30 seconds during heat chamber “PURGE” cycle, removing any propane out if any.
6. Second cycle, blower continues to run, module board will: (a) send spark to burner tube, (b) open valve in control to release propane to burner tube.
7. Ignition attempt will be for 7 seconds.
8. Failing to ignite, board will make 2 more attempts and go into lockout if it fails.
9. Drop thermostat down to lowest setting, wait 1 minute and repeat steps 4 to 7. Air in line prevents burner from lighting.
10. After burner lights, set thermostat to desired temperature.
11. To shut burner down, move thermostat to lowest setting.
12. Blower will continue to run for about 2 minutes until heat is removed from chamber.

Note: There is a switch on furnace to shut off 12 volt DC power. Furnace will not operate on "OFF" position.

NOTE: If the furnace should lock-out, the blower will go off in 2 to 5 minutes and remain off until unit is reset by reactivating thermostat. See #8.

NOTE: These operating instructions will vary depending on the furnace size and model. Refer to the furnace manufacturers information manual in your unit for the complete furnace operating instructions, for you unit.

TO TURN OFF FURNACE

1. Set the thermostat to lowest setting, then move lever or switch to "OFF" position.
2. Turn off all electric power to the appliance if service is to be performed.



WARNING

DO NOT install screens over the vents for any reason. Screens will become restricted and cause unsafe furnace operation. Accessories are being marketed for RV products which KZRV does not recommend. For your safety, only factory authorized parts are to be used on your furnace.

External Vents. Always be sure these vents are clear of any objects like screens, or duct tape, BEFORE ATTEMPTING TO OPERATE.

Ducting. Wall or floor registers, and return air grills MUST be kept clear of any obstructions. Any such restrictions will prevent the furnace from full operation. Closeable registers will reduce air flow. Never shut any register off completely, possibly causing furnace to limit out and shut down.

Propane pressure, as defined in Chapter Four Systems, is extremely important. A dial gauge, manometer or U-tube is required to perform tests and to make adjustments. Pressure must be set at

11 inches WC, (water column) plus or minus 1/2 inch. Incorrect gas pressure can cause any appliance to operate inconsistently and have poor combustion. Only qualified technicians with proper equipment should make any mechanical adjustments.

Voltage must be between 10.5 volts to 13.5 volts at the furnace during operation. Below 10.5 volts the furnace will shut down. Both high and low voltage places excessive wear on the motor and brushes.

Speed of blower is altered by voltage, low voltage slows blower down, sail switch fails to open and the result is no heat,

Any mechanical adjustments, such as electrode adjustments or propane adjustments must be performed by a qualified service technician.

RANGE AND OVEN TOP BURNER OPERATION

The Toy Hauler group use the standard oven with three top burners. These appliances operate with propane only, NEVER natural gas or butane.

Stove top burners do not have a standing pilot light and need to be lit each time they are used. Each top burner has a igniter, fed by a PEIZO LIGHTER, to ignite each burner each time for cooking. Hand held matches or igniter can be used with care but not required.



WARNING

Be sure all control knobs are turned "OFF" when you are not cooking. Someone could be burned or a fire could start if a burner is accidentally left on or unattended even if only momentarily.

OPERATING INSTRUCTIONS

TOP BURNERS

1. Know which knob controls which burner. Always be sure all burners are turned off when the stove is not in use.
2. Verify sufficient propane supply before attempting to light the burner ports.

3. Depress knob and turn fully counterclockwise to “LITE” position.
 - a. Air in the propane line will significantly delay burner ignition. The burner may light unexpectedly as the air in the lines clears and is replaced with propane. This unexpected ignition could burn you. Air in the propane lines may occur after the vehicle propane bottle and/or tank is refilled, during and after servicing other appliances on the same propane line, etc.
 - b. Do not attempt to light more than one burner at a time.
 - c. Immediately light the burner by turning piezo lighter clockwise.
4. If any burner should extinguish after initial lighting or due to accidental blow out, turn propane off by turning control knob clockwise to “OFF”. Wait five minutes before attempting to relight the burner.

If the burner should go out while cooking, or if there is an odor of propane, turn the control knob (s) clockwise to “OFF”. Wait five minutes for the propane odor to disappear. If the propane odor is still present – DO NOT relight the burners. See instructions in the appliance manual.
5. To turn the burner (s) off, turn the appropriate control knob clockwise to “OFF”.





CAUTION

Hand held igniters may be used but be sure they are the type designed for lighting open flame burners. Use peizo as supplied.



WARNING

When holding the match or lighter to ignite flame, DO NOT position your fingers close to the burner. You could get burned causing injury.

Oven Burner

Note: Before the oven burner will operate, the oven pilot MUST be lit.

1. Lighting Oven Pilot
 - a. Be sure ALL valves are in the "OFF" position. The oven control knob should be in the "Off" position.
 - b. Be sure main propane supply is on.
 - c. Open the oven door. If you smell propane, STOP! Read and follow the instructions in your appliance manual.
 - d. If you do not smell propane, turn knob to the pilot position. "Push In/Light Pilot"
 - e. Immediately light pilot with a match. Hold knob in at least 5 to 7 seconds, for this allows propane to flow to pilot and to heat the thermocouple. Release knob, pilot should stay on. NOTE; If the appliance has not been operated for a long period of time, a longer waiting period for ignition of the pilot may be due to the air in the pilot and propane lines. If pilot goes out, repeat, repeat steps a, b, c, d.
2. Operation of Oven Burner
 - a. Turn the oven control knob counter-clockwise to the desired setting. Oven burner will come on immediately and the oven burner will stay on until it reaches the desired setting. Then the oven burner flame will decrease in size. This is normal for this type of thermostat and this flame size will maintain a constant temperature within the oven. NOTE: Oven thermostat was calibrated at the factory and is not field adjustable

3. To shut down the oven burner turn the oven control knob clockwise to “PILOT ON” position. At this position, the oven pilot will remain lit.
4. To shut down the oven pilot light, slightly depress knob and turn clockwise to “OFF” position. At this position, the oven pilot will go out.

Have the propane system checked and leakage source corrected by a qualified installer, service agency, manufacture or dealer or the propane supplier.

	DANGER
ALL PILOT LIGHTS, APPLIANCES AND THEIR IGNITORS (SEE OPERATING INSTRUCTIONS) SHALL BE TURNED OFF BEFORE REFUELING OF MOTOR FUEL TANKS AND/OR PROPANE CONTAINERS. FAILURE TO COMPLY COULD RESULT IN DEATH OR SERIOUS INJURY.	

	DANGER
DO NOT use gas cooking appliances for comfort heating. Can lead to carbon monoxide poisoning which can lead to death or serious injury.	

Gas cooking appliances need fresh air for safe operation.
Before operating:
Open vents and/or windows slightly or turn on exhaust fan prior to using cooking appliances.
Gas flames consume oxygen, which should be replaced to ensure proper combustion.
Improper use can result in death or serious injury.

WATER HEATER

OPERATING INSTRUCTIONS—PROPANE

- A. This appliance does not have a pilot. It is equipped with an ignition device which automatically lights the burner. DO NOT try to light the burner by hand.

- B. BEFORE LIGHTING, open windows and allow air to move through out camper. Be sure to search and ventilate floor area as propane is heavier then air and will settle on the floor.
- C. This is an automatic propane valve, no adjustments are possible. Do not attempt to repair the propane valve.
- D. Do not use this appliance if any part has been under water. Immediately call a qualified service technician to inspect the appliance and to replace any part of the control system and any gas control which has been under water.
- E. Before operating water heater, check the location of the vent to make sure it will not be blocked by the opening of any door on the trailer. If it can be blocked, do not operate the water heater with the door open.

	WARNING
<p>It is imperative that the water heater tank be filled with water before operating the water heater. Operation of the water heater without water in the tank may result in damage to the tank and/or controls. This type of damage is not covered under warranty.</p>	

OPERATING INSTRUCTIONS FOR UNITS WITH DIRECT SPARK IGNITION GAS VALVE.

1. Full operation and ignition occurs on the external side of this appliance. By removing outside cover it will evacuate any odors or propane should there be any.
2. Be sure propane supply and 12 volt DC are available.
3. Turn "ON" the propane supply.
4. Turn on electrical power to the appliance.
5. Turn switch marked "WATER HEATER" which is located on the monitor panel, to "ON" position. If the burner does not light, the system will automatically attempt two more tries for ignition before lock out. NOTE: Each ignition cycle will have a fifteen second purge before spark cycle if the system is a three try System.

6. If lock-out occurs before main burner lights, turn switch to "OFF" wait five seconds and turn switch to "ON" position. This will restart the ignition cycle. The first start-up of the heater may require several ignition cycles before all air is purged from the propane lines.

If the burner will not come on, the following items should be checked before calling a service person.

1. Switch turned off.
2. Propane supply to heater is empty or turned off.
3. Reset button on ECO is tripped.
4. If burner fails to light, call a Suburban Service center or a local RV Service agency



CAUTION

When the recreational vehicle is not in use or while traveling, it is recommended that the gas supply also be turned off.



DANGER

If the user of this appliance fails to maintain it in the condition in which it was shipped from the factory or if the appliance is not used solely for its intended purpose or if the appliance is not maintained in accordance with the instructions in this manual then the risk of a fire and/or the production of carbon monoxide exists which can cause personal injury, property damage or loss of life.



CAUTION

The thermostat on your water heater is not adjustable. It is a temperature sensing limit designed to maintain a water temperature of 130 degree F (54 degree C). Water temperatures over 130 degree F (54 degree C) can cause severe burns instantly or death from scalds; therefore, be careful when using hot water. Children, disabled and elderly are at highest risk of being scalded. Always feel water before bathing or showering.

OPERATING INSTRUCTIONS—ELECTRIC ELEMENTS

Electric water heaters are designed to operate with a minimum amount of service problems, however, proper operation and care is essential.

By far the most common trouble with electric water heaters results from energizing the water heater before it is filled with water. Even brief operation of the electric element without water in the tank will burn out the electric heating element.

Before the electric element will operate, the switch located behind the water heater door in the lower left corner of the control housing must be in the "ON" position.

To energize the electric element, locate the switch, which is on the bottom of the monitor panel, inside the RV and turn the switch marked "ELECTRIC" to the "ON" position. The water heater temperature will be regulated by the thermostat.

To Turn Off Water Heater:

1. Turn switch to "OFF" position.
2. Turn off the electrical power to the appliance.
3. Turn off propane supply.
4. If the vehicle is to be stored or the heater is going to be turned off while subject to freezing temperature, drain the water heater.



CAUTION

DO NOT operate the water heater with two energy sources in operation or without water.

Winterizing Your Water Heater

If your water heater plumbing system is equipped with a bypass kit, use it to close off the water heater. Drain the water heater completely and leave the water heater closed off (out of the system)

in the bypass position particularly if you are introducing antifreeze into the plumbing system. The by pass kit will have valves on the top and bottom, valve on bottom needs to be turned to divert water from entering water heater, and valve on top will keep water from flowing back into the water heater

Antifreeze can be very corrosive to the anode rod creating premature failure and leave sediment in the tank. If the plumbing system is not equipped with a bypass kit, and you intend to winterize by adding antifreeze to the system, remove the anode rod (storing it for the winter) and replace it with a 3/4 inch drain plug.

REFRIGERATOR

KZ recreational vehicles installs and uses several brands and types of refrigerators. These appliances will use and consume propane, 12 volt DC and 120 volt AC power, to keep temperature down at 34 to 36 degrees to protect your food.

2 types of cooling units

1. Absorption system requires precise leveling within 1 degree as listed below.
2. 12 volt compressor being supplied by 120 AC power to produce cooling to protect your food.

LEVELING

For correct operation, the refrigerator **MUST** be within three degrees of being level in any direction. At 1 degree out of level, it will have one end of a 30 foot travel trailer 5" higher than the other end, not a comfortable situation. Continued operation outside these limits will result in irreparable damage to all types of cooling units. Make sure your coach is as level as possible. You will enjoy your camping experience better.

VENTING

For an absorption unit to operate correctly, it **MUST** have two vents. The lower vent serves as access to service components and allows air to enter, flow upward, taking hot air out at the top vent. As the refrigerator heats up, warm air leaves through the upper vent in the roof or the upper side vent. The roof vent gives the best "chimney" results. However with correct baffles installed, side vent is good. All vents must prevent birds and rodents from entering.

Door Sealing

Check the seal of the door.

If either door does not seal correctly, excess frost will collect inside the refrigerator. Make sure the doors seal correctly.

* Close each door on a piece of paper that is about the size and thickness of a dollar bill.

* Gently pull the paper.

* You should feel a slight drag between the gasket and the cabinet.

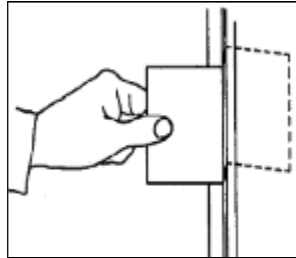

* Do this on all four sides.

* If you do not feel a slight drag on the paper, the door does not seal correctly.

* Have your dealer or an authorized Norcold Service Center correct the seal of the door.

Door Handles

During travel, the door latch prevents the door from opening. When closing each door, push the door toward the refrigerator until you hear a “clicking sound”. To open each door, pull the handle away from the refrigerator.



CAUTION

Do not use undue force or jerking action when opening the refrigerator door. Air temperature differences can cause a partial vacuum within the cabinet requiring a firm but steady force to open the door. A sudden jerk could cause door damage or personal injury.

Refrigerator Storage

Before the refrigerator is stored for an extended (seasonal) period of time:

Defrost and clean the interior of the refrigerator.

If the refrigerator is stored for an extended period of time, before startup:

Make sure there are no obstructions in the vents, the ventilation air pathway, the burner, the orifice, or the flue area.

For Defrosting and Cleaning the Refrigerator Interior, and other additional information and operating procedures, see the manual being supplied by the manufacture.

OPERATING THE REFRIGERATOR CONTROLS

Control Panel

The refrigerator control panel is between the freezer compartment and the fresh food compartment. A 12 volt DC power supply is necessary for the control functions of the refrigerator to operate. The refrigerator receives DC power from the 12 volt system of the vehicle, either an auxiliary battery, a convertor, or the vehicle engine battery.

Two types or systems are currently being used, on both you turn the switch to "ON" and it will operate the refrigerator.

Both the N8 and N7 models have a letter, "V" or "X" behind the number.

X means the system will choose "AC" 120 volt first even with propane available. To change temperature in box, move slide switch from 1 to 5, with 5 being the coldest.

V will switch to 120 volt AC first, much the same as X, however to change the temperature setting, you must physically move the thermistor and wire from the 10th position left, 2 or more fins for colder operation inside the box.

On the 12 volt DC compressor type, to change inside temperature of box, move slide switch in freezer compartment in direction you wish to go, colder or warmer.

ALWAYS PRECOOL the refrigerator for 8-12 hours before placing food into the box.

Operating during travel, the movement will keep all chemicals in motion and operating correctly.

See your instruction manual as supplied by manufacture of appliances in your coach.

MONITOR PANEL

Your panel through modern technology will give the charge condition of your battery and water level information from your water tanks.

Operation requires 12-volt DC power, supplied by the battery or converter. Sensors, one negative and three positive, attached to a resistor feed information to the display panel. To operate, place finger on button and push. A light will illuminate indicating the water level of tanks or charge condition of battery. "Galley" will light only when floor plan includes the second gray water holding tank.

The switch on the lower left corner of the monitor panel is for water pump operation. When in the "ON" position, pump will run until 40 to 45 PSI is achieved. The pump will shut off and restart at 20 pounds of pressure. Turn pump switch "OFF" when pump is not in use.

The red switch in the middle at the bottom of monitor panel is for the "Water Heater LP gas." Red switch, lower right hand corner is for "Water Heater electric." BE SURE there is water in this heater before turning switch on.

When pushing the battery button, the highest light coming on indicates the battery condition: C-charging at 12.7 volts; G-good at 11.9 volts; F-fair at 11.2 volts; L-low at 6.0 volts. Press only one button at a time as one set of lights serves all functions.

If problems occur with any appliance while traveling, contact the appliance manufacture direct. These



phone numbers are listed in the appliance manual. Manuals should stay in unit at all times.

OUTSIDE KITCHEN (OPTIONAL)

Using this exterior kitchen will eliminate traffic inside of your camper and perhaps avoid a food spill.

Two sizes are available, depending on model and space, a tall or short version.

1 Cook top is a two burner hot plate and has no standing pilot light. Each use requires re-lighting the burner. A removable propane hose is required and supplied with quick connectors for fuel from propane system.

2. A refrigerator is also a part of this package, 120 volt AC compressor type unit. Small unit is 1.6 cu. feet and tall unit is 3.2 cu. feet. No propane or 12 Volt DC is required or available for operation.

3. Small sink and faucet is also part of the kitchen. Drainage of used water will go into the holding tank, thru a flexible hose. It also serves as an outside shower port. A hose and sprayer is included.

4. A second microwave is included with the tall kitchen. You will have to choose which one to use. A switch is inside the camper, generally in the ceiling called a " Double pole/ Double throw" switch. There is only 30 amp service available, which is why you must make this choice.

5. Another feature available on some kitchens is a TV set inside to watch under awning and watch programs in fresh air.

Please note—NOT all of these items can be in one kitchen!



WARNING

1. When using this outside cooking area, the vehicle **MUST** be level and stabilized.
2. **DO NOT** violate manufactures instructions on required clearance for cooking appliances during use.
3. **DO NOT** store cooking appliances until cool enough to touch.
4. Can lead to a fire and explosion and result in serious injury or death

PORTABLE SOLAR PANEL RECEPTACLE

Such a receptacle for solar panel may be installed on your coach, on the exterior or right front corner. The actual panel is an after market item, and is not sold or furnished by KZ.

It's main function is to maintain a charge for an auxiliary battery you may have installed on your coach.

Brand name on decal indicates as to what brand to purchase.

BACK-UP CAMERA

A special bracket has been installed on the rear of your coach, just below clearance light to mount the camera.

Bracket has black and red wires to be connected to 12 volt DC energy from coach system to activate the camera.

Camera may be purchased from your dealer.

This system is intended for back-up use only.

